

DEMOLITION TENDER BASEMENT VAULTS - WEST

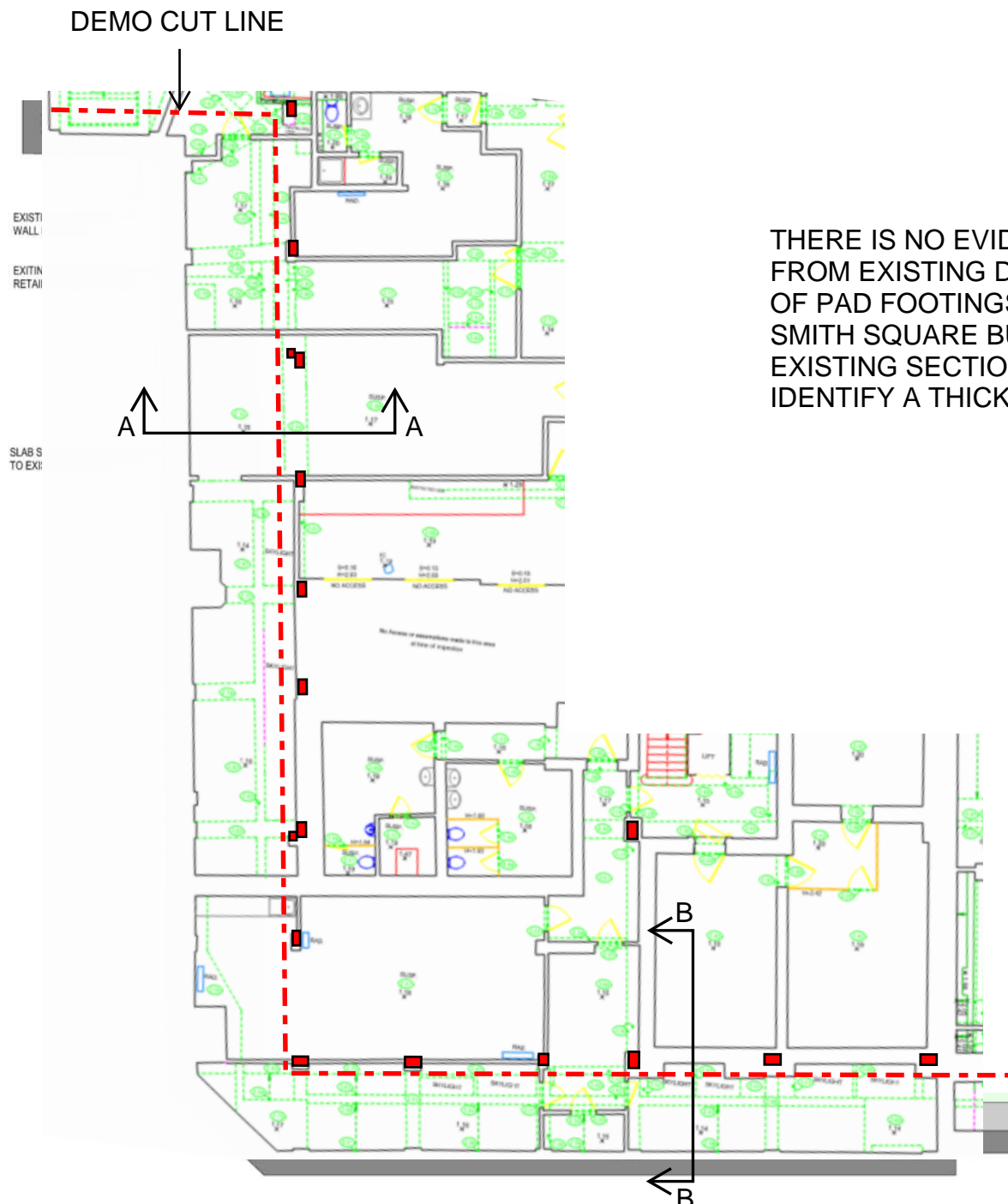

THERE IS NO EVIDENCE FROM EXISTING DRAWINGS OF PAD FOOTINGS BENEATH SMITH SQUARE BUILDING. EXISTING SECTIONS IDENTIFY A THICK RAFT

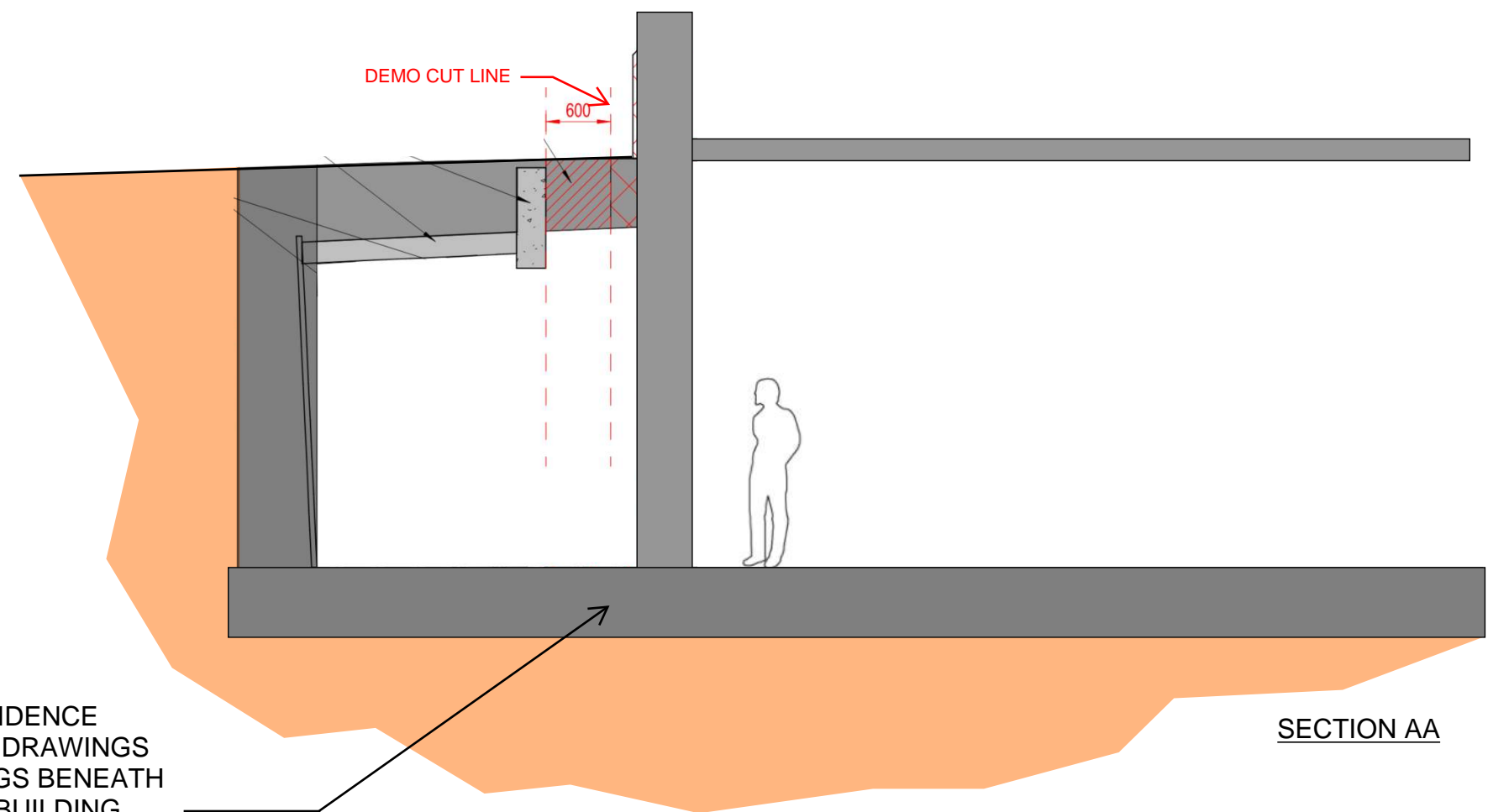

SECTION AA

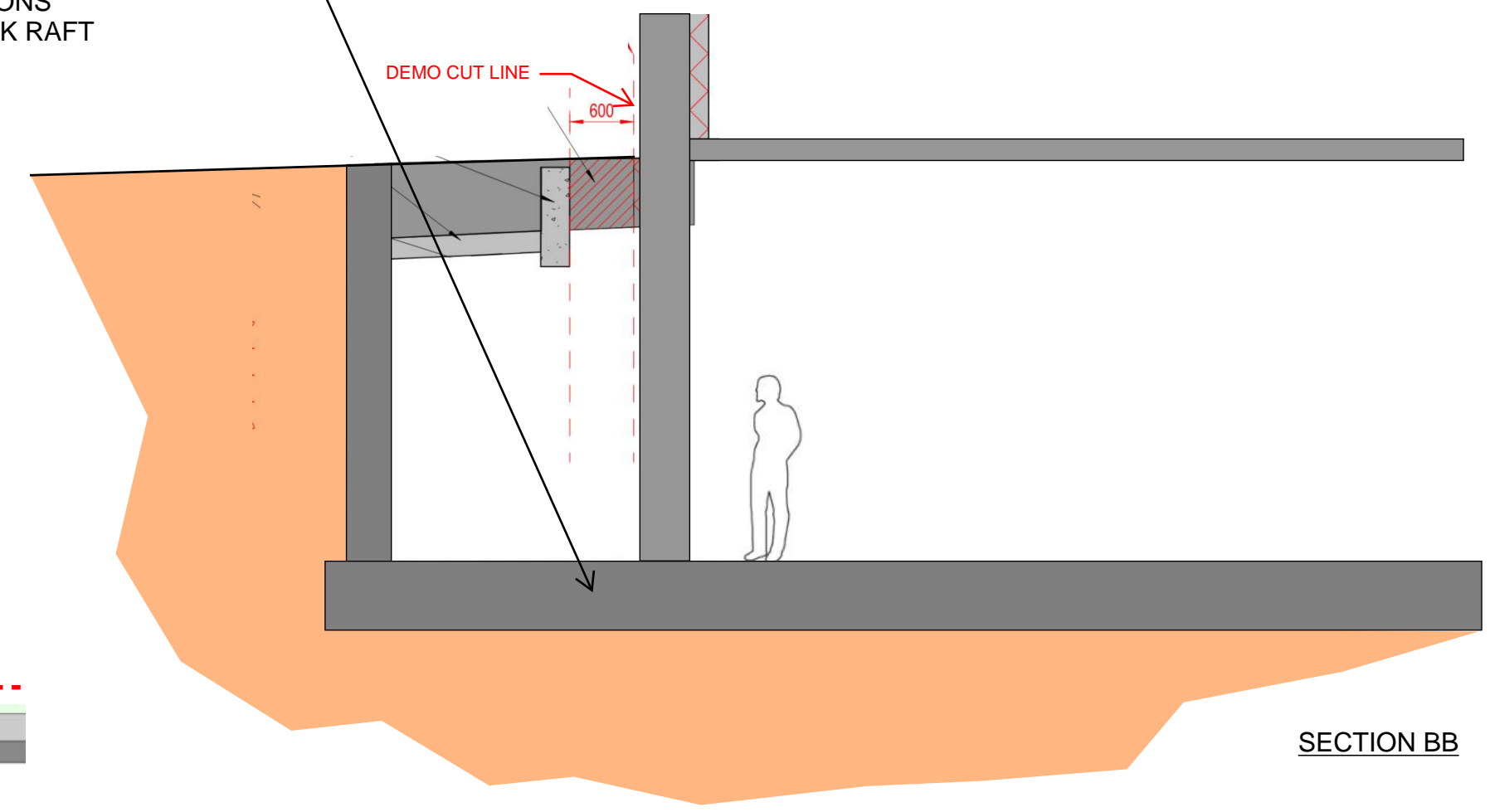

SECTION BB

PROJECT TITLE	SKETCH TITLE	SKETCH No.	DRAWN	DATE
			SCALE	REV.

McGEE
A Specialist Engineering Contractor
McGee Group (Holdings) Ltd
Level 9 Alto Tower, 5 Hatfields
London SE1 9PG
Tel: 020 8998 1101 Fax: 020 8997 7690

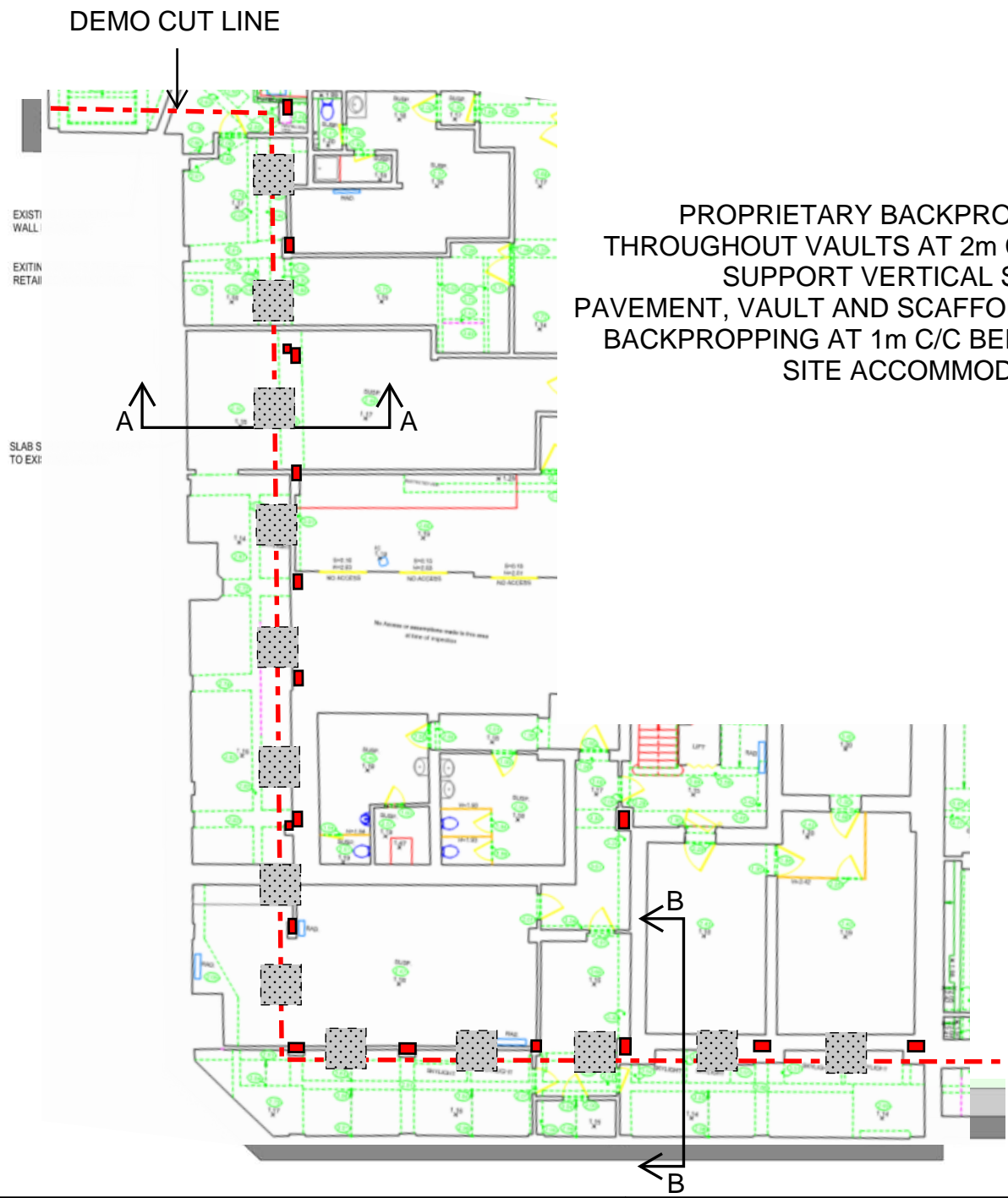

PROPRIETARY BACKPROPPING THROUGHOUT VAULTS AT 2m C/C TO SUPPORT VERTICAL S/W OF PAVEMENT, VAULT AND SCAFFOLDING. BACKPROPPING AT 1m C/C BENEATH SITE ACCOMMODATION

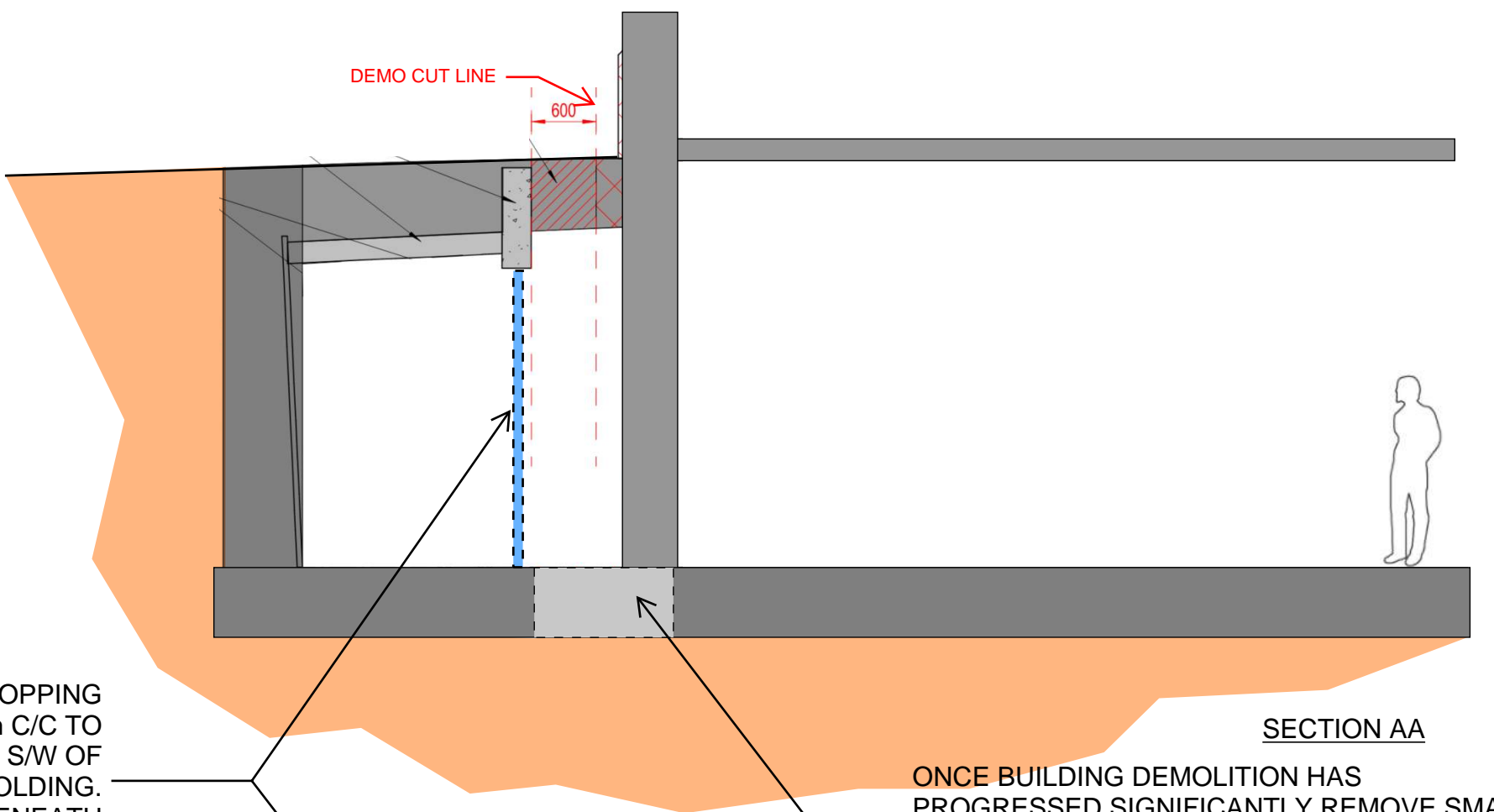

ONCE BUILDING DEMOLITION HAS PROGRESSED SIGNIFICANTLY REMOVE SMALL 1.5m x 1.5m SECTIONS OF THE EXISTING RAFT AT THE LOCATION OF EACH PROP AS SHOWN AND BACKFILL WITH PLAIN CONCRETE.

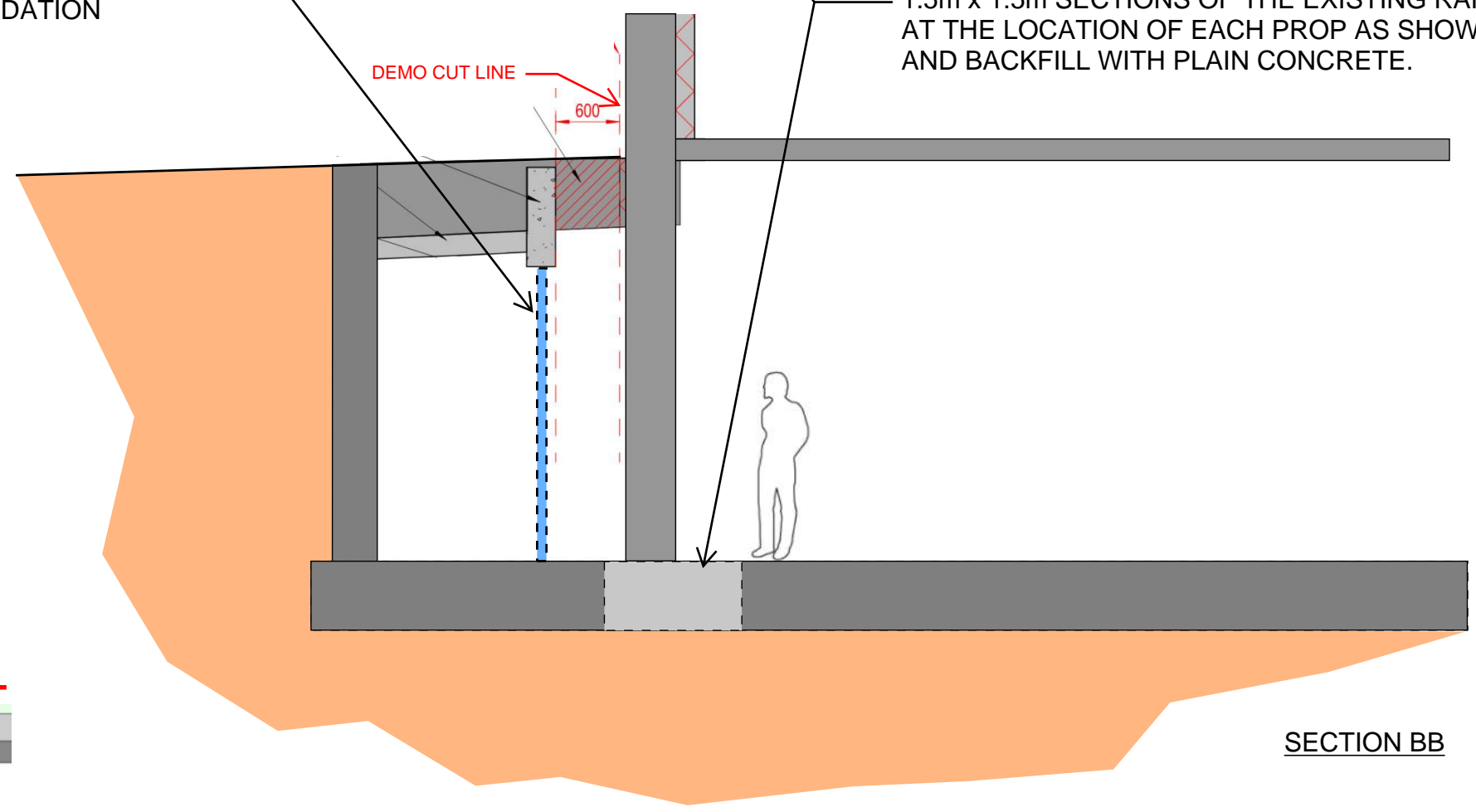

PROJECT TITLE	SKETCH TITLE
---------------	--------------

SKETCH No.

DRAWN	DATE
SCALE	REV.

DRAWN	DATE
SCALE	REV.

McGEE
A Specialist Engineering Contractor

McGee Group (Holdings) Ltd
Level 9 Alto Tower, 5 Hatfields
London SE1 9PG
Tel: 020 8998 1101 Fax: 020 8997 7690

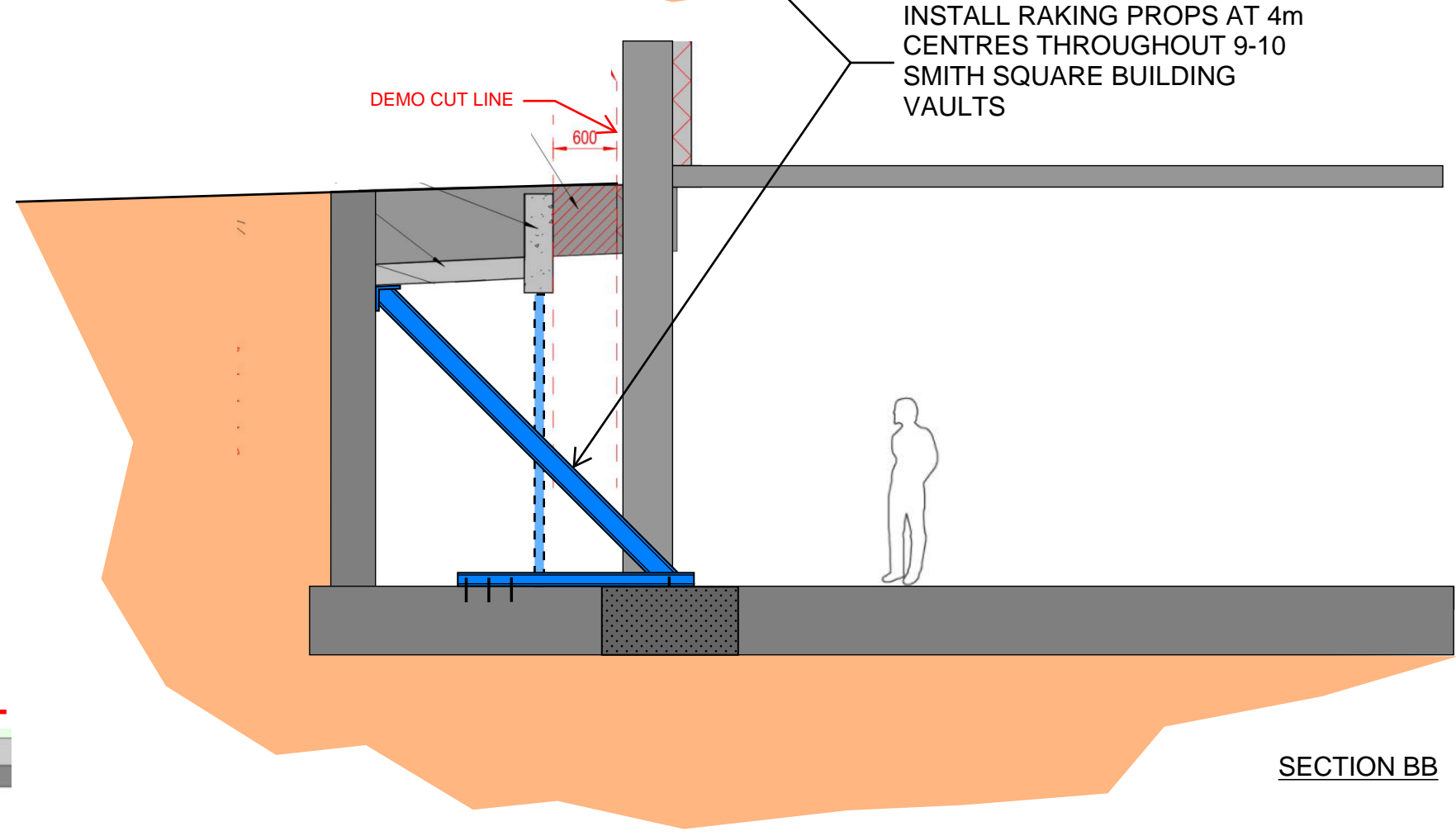
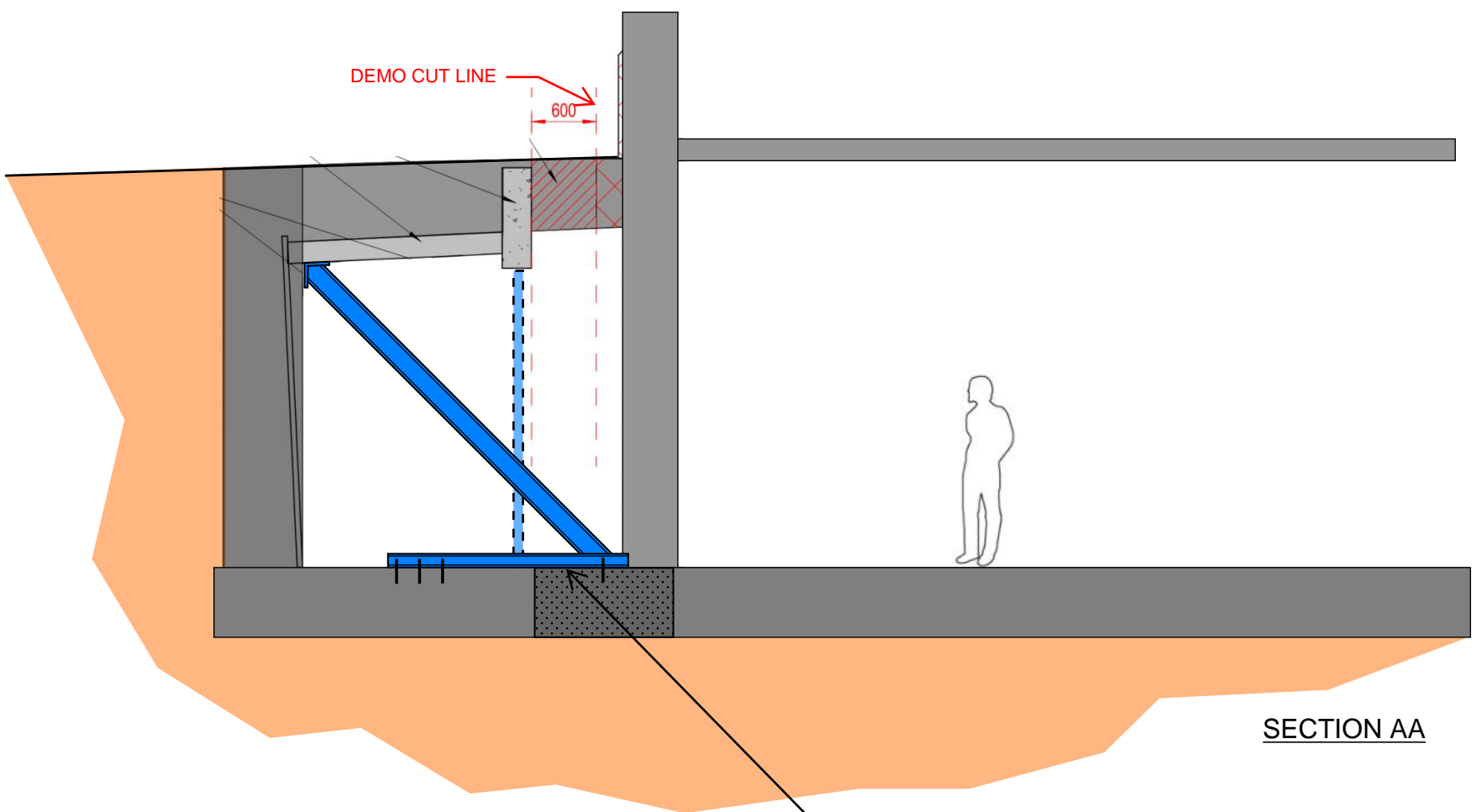
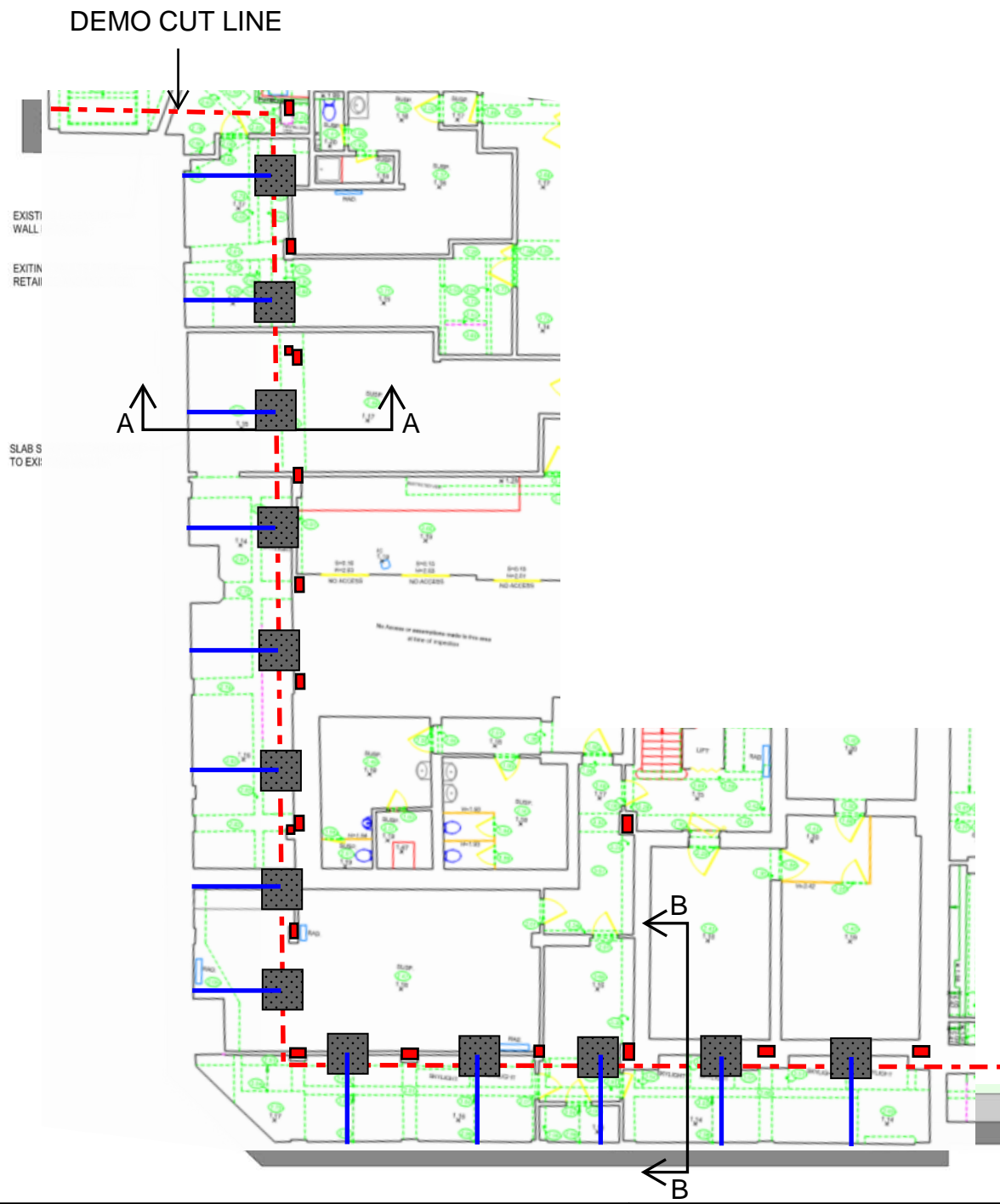

INSTALL RAKING PROPS AT 4m CENTRES THROUGHOUT 9-10 SMITH SQUARE BUILDING VAULTS

PROJECT TITLE	SKETCH TITLE	SKETCH No.	DRAWN	DATE	 <p>McGEE A Specialist Engineering Contractor McGee Group (Holdings) Ltd Level 9 Alto Tower, 5 Hatfields London SE1 9PG Tel: 020 8998 1101 Fax: 020 8997 7690</p>
			SCALE	REV.	

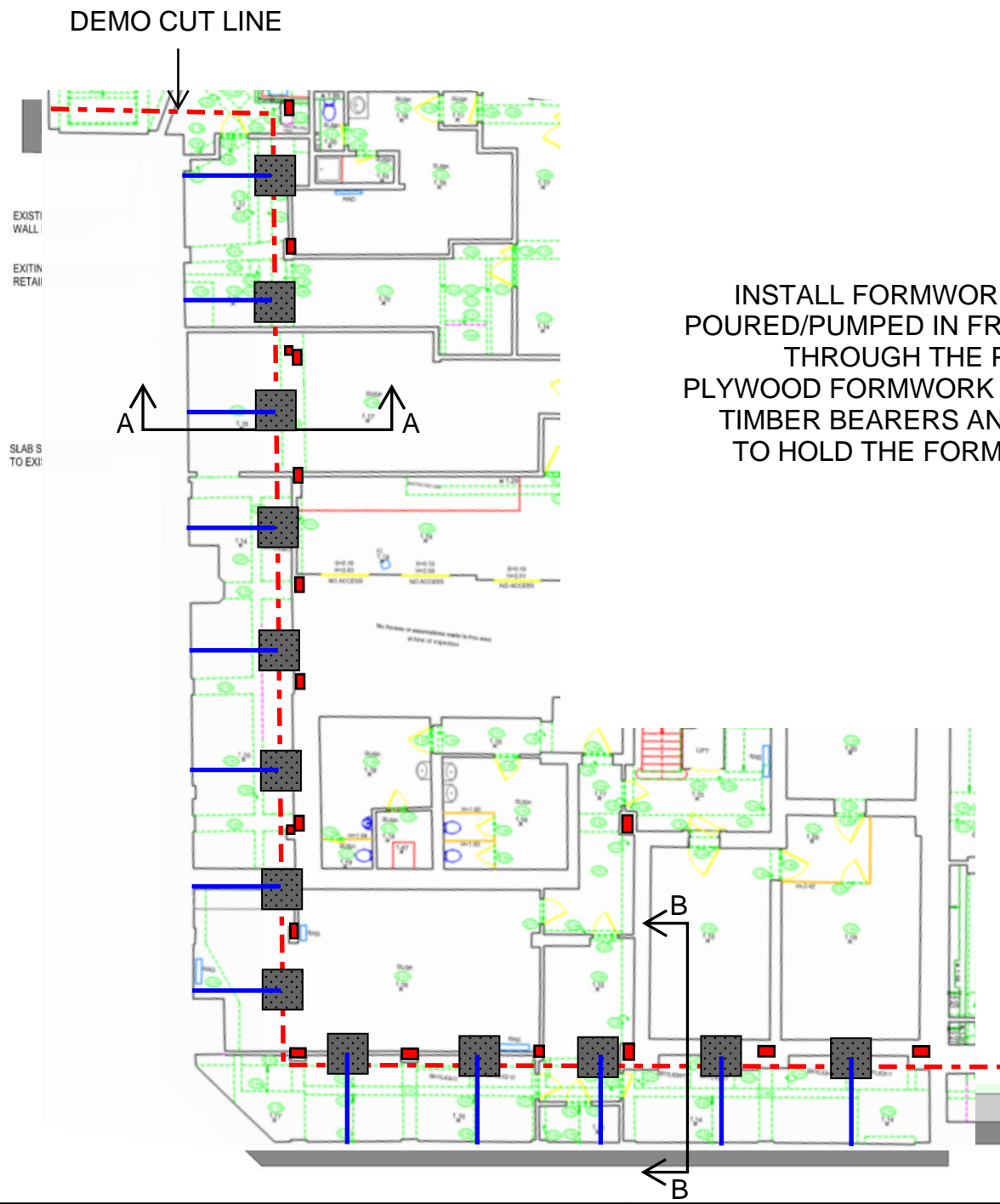

INSTALL FORMWORK FOR SAND TO BE
POURED/PUMPED IN FROM STREET LEVEL
THROUGH THE PAVEMENT LIGHTS.
PLYWOOD FORMWORK WITH HORIZONTAL
TIMBER BEARERS AND STEEL TIE RODS
TO HOLD THE FORMWORK TOGETHER.

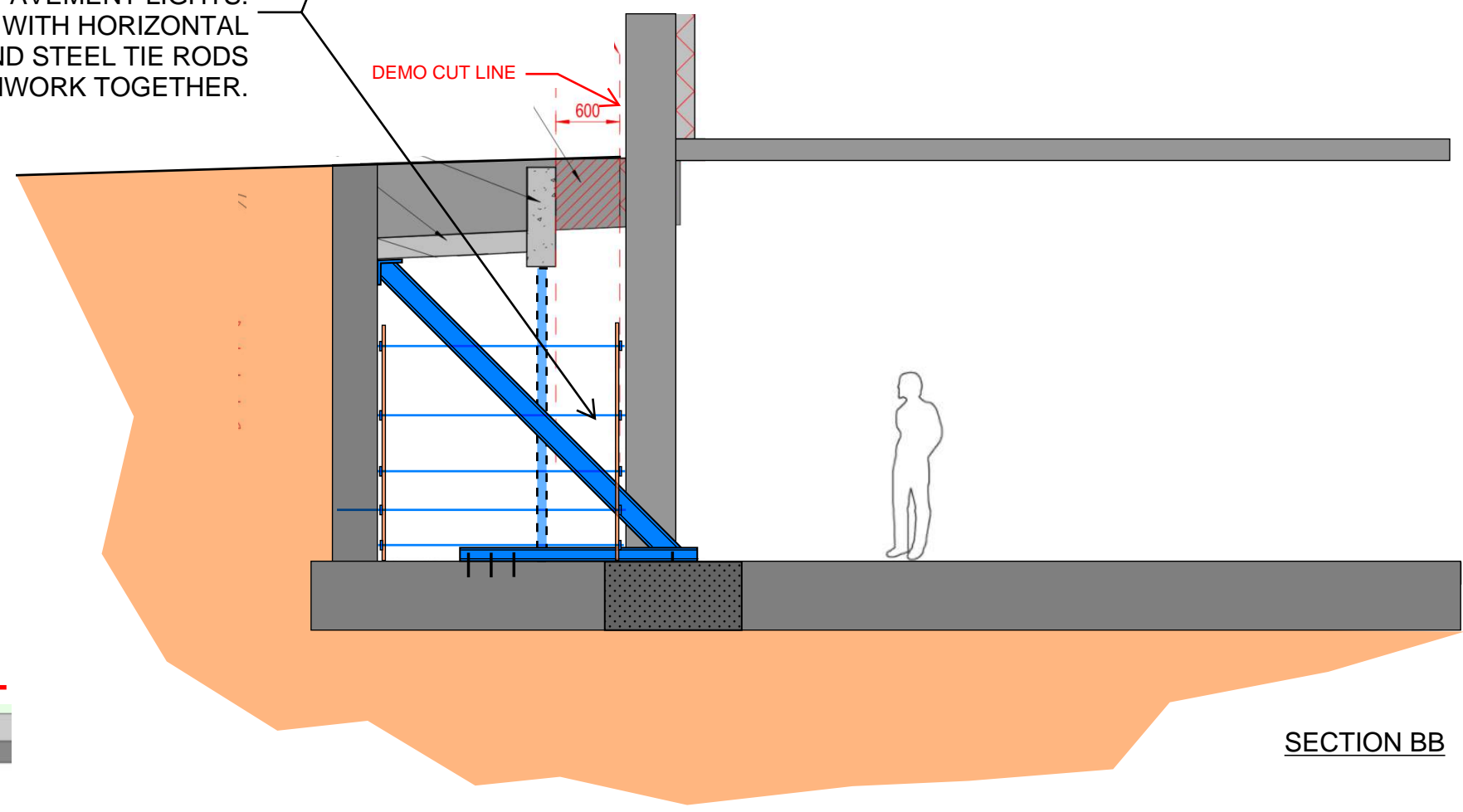
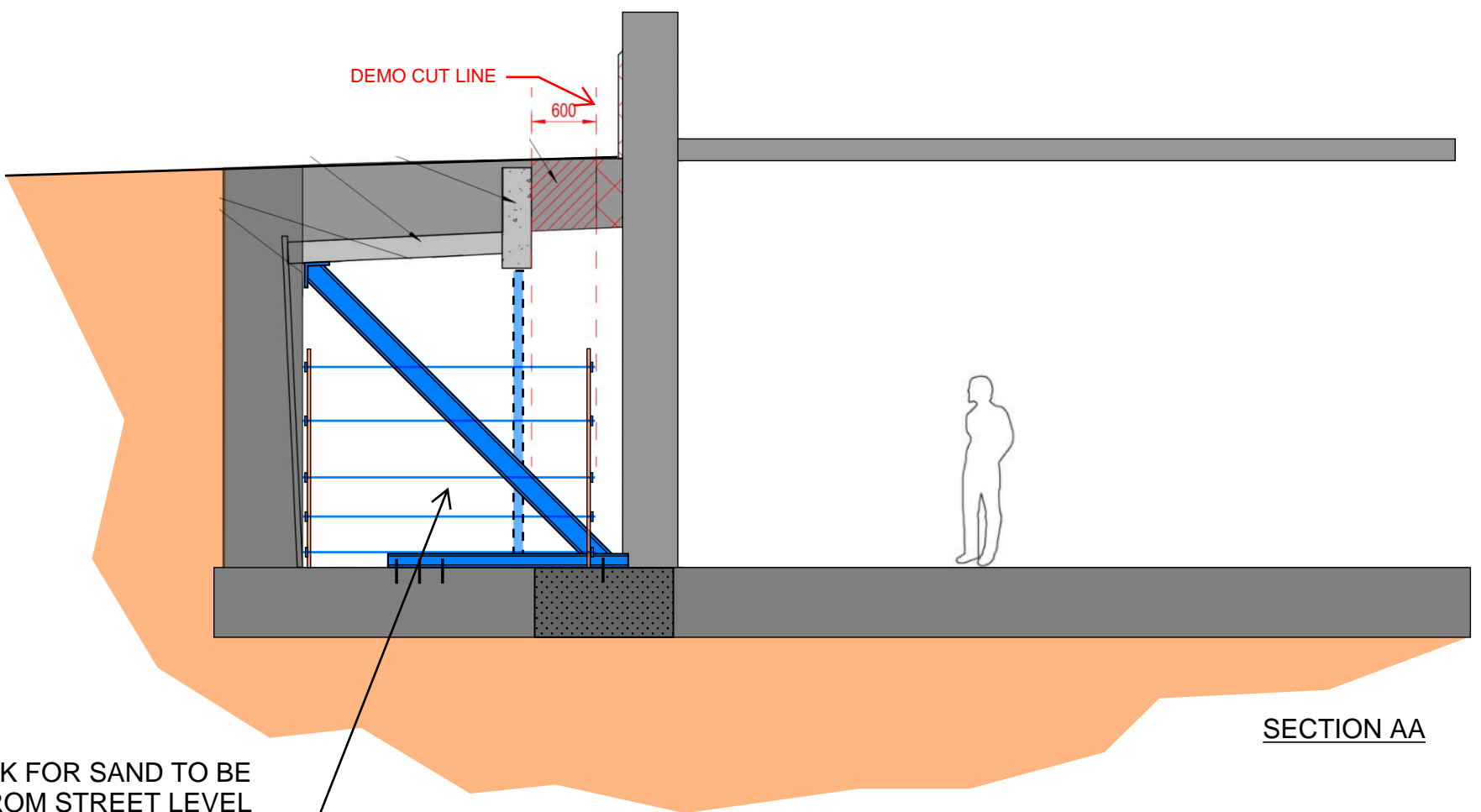

PROJECT TITLE

SKETCH TITLE

SKETCH No.

DRAWN
SCALE

DATE
REV.

McGEE
A Specialist Engineering Contractor

McGee Group (Holdings) Ltd
Level 9 Alto Tower, 5 Hatfields
London SE1 9PG
Tel: 020 8998 1101 Fax: 020 8997 7690

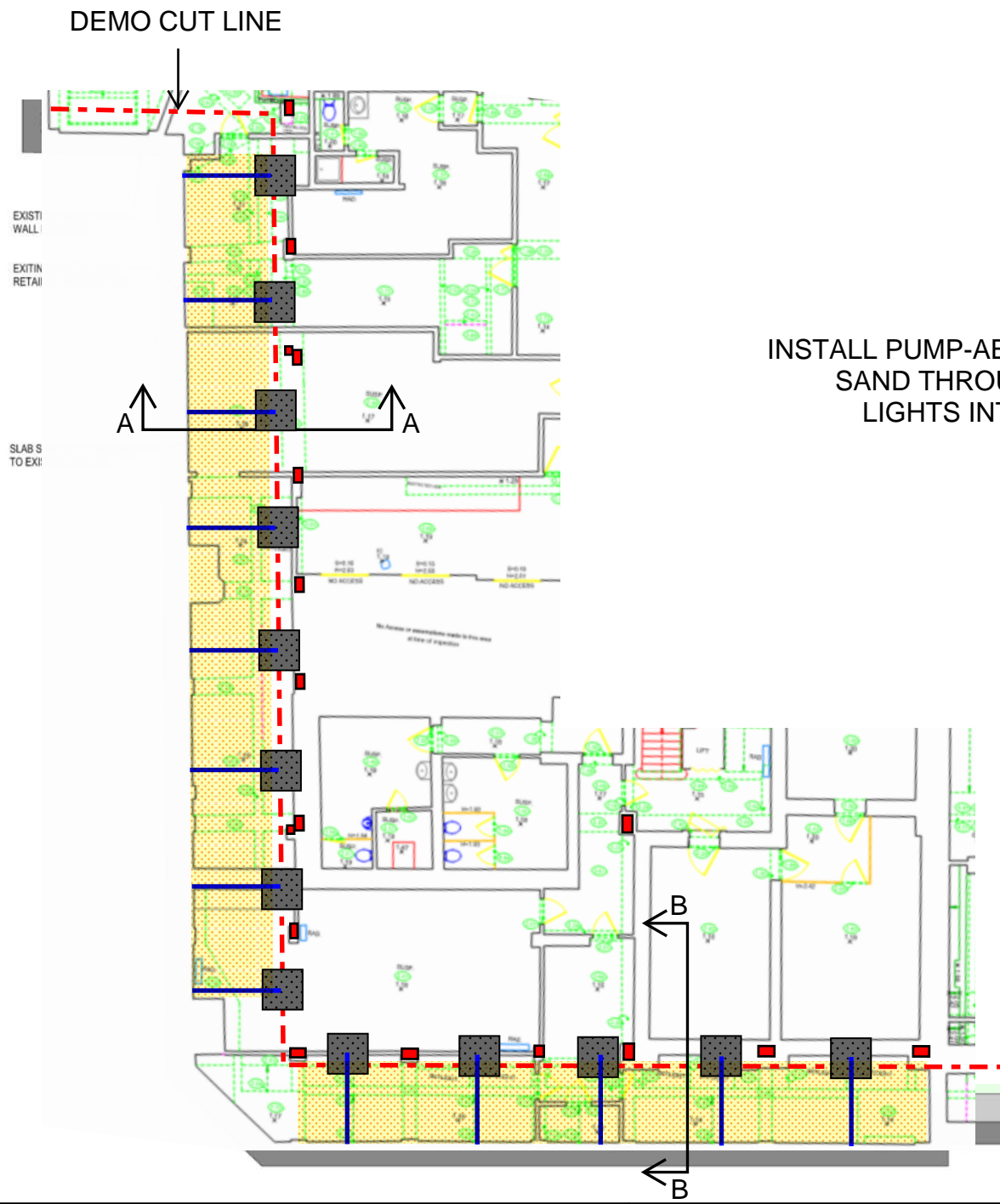

INSTALL PUMP-ABLE FINE/SHARP SAND THROUGH PAVEMENT LIGHTS INTO FORMWORK.

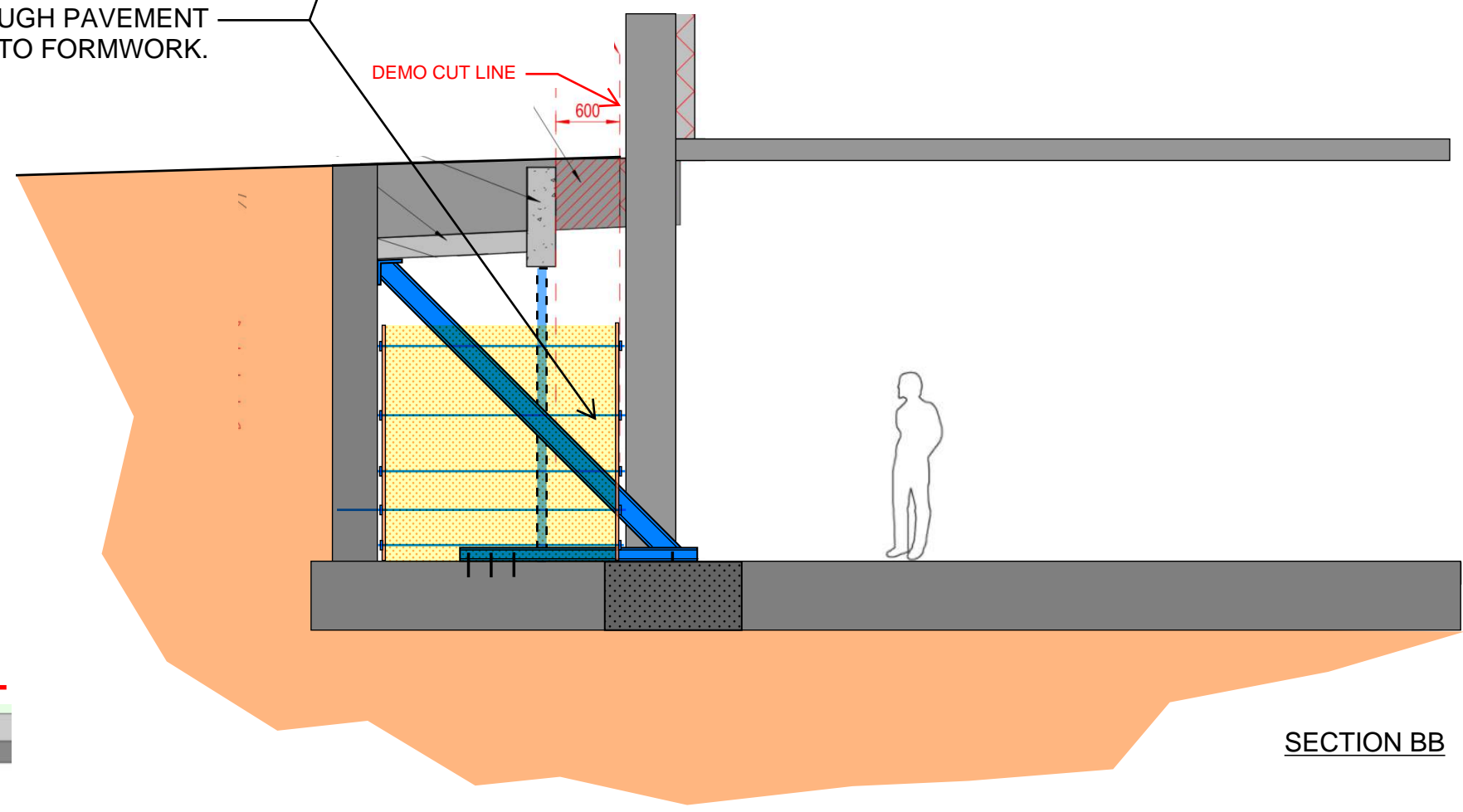
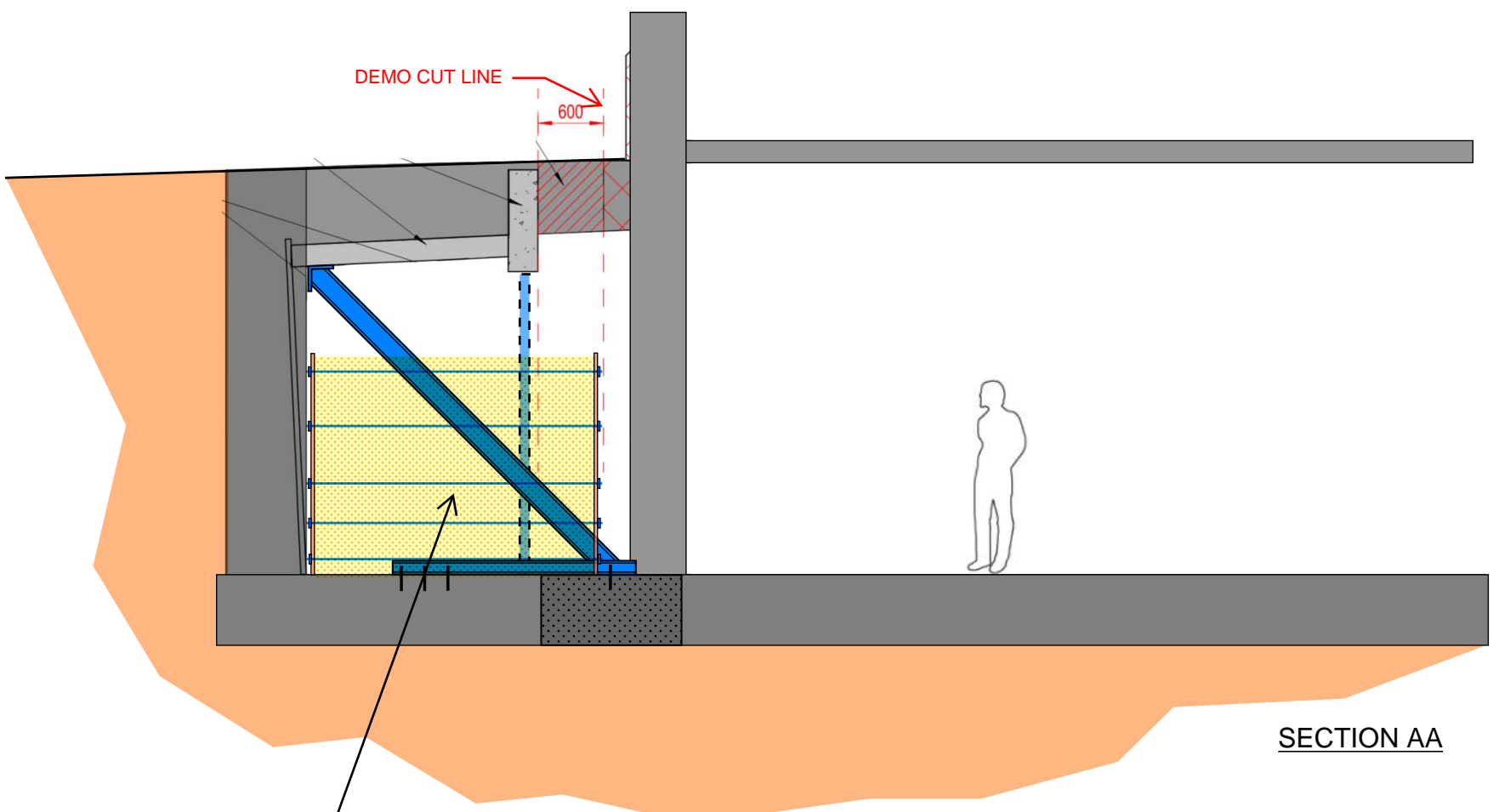

PROJECT TITLE

SKETCH TITLE

SKETCH No.

DRAWN

DATE

SCALE

REV.

McGEE
 A Specialist Engineering Contractor
 McGee Group (Holdings) Ltd
 Level 9 Alto Tower, 5 Hatfields
 London SE1 9PG
 Tel: 020 8998 1101 Fax: 020 8997 7690

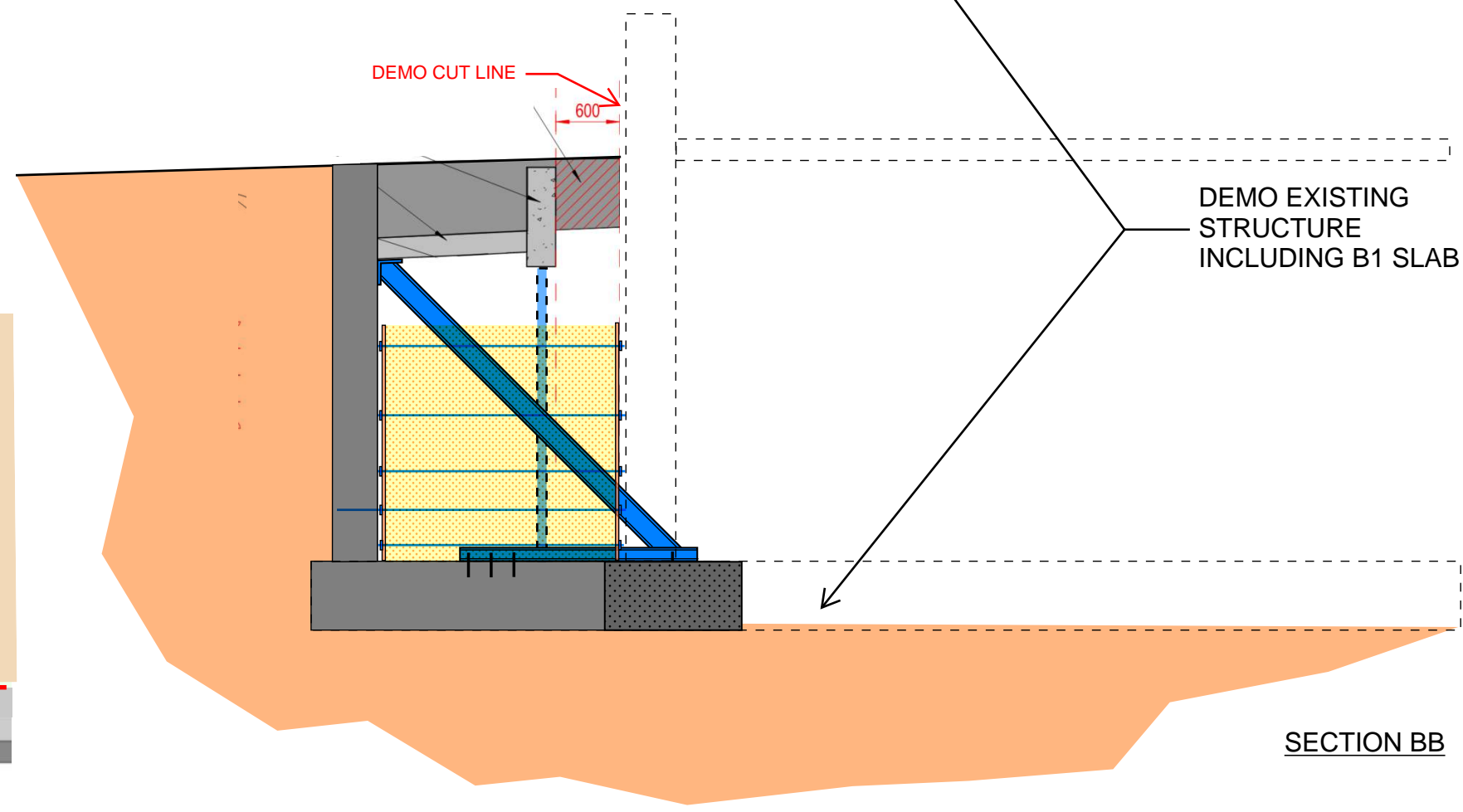
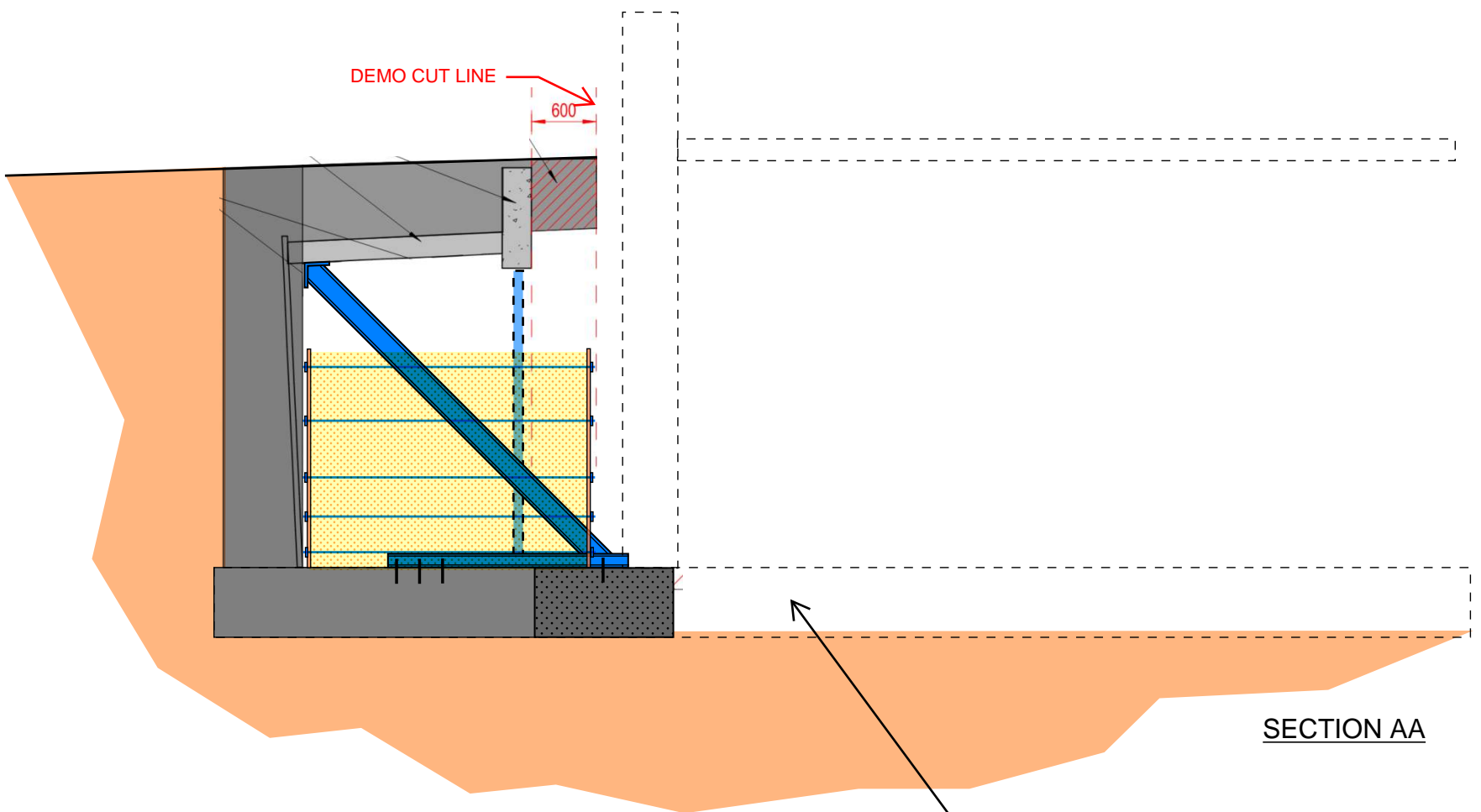
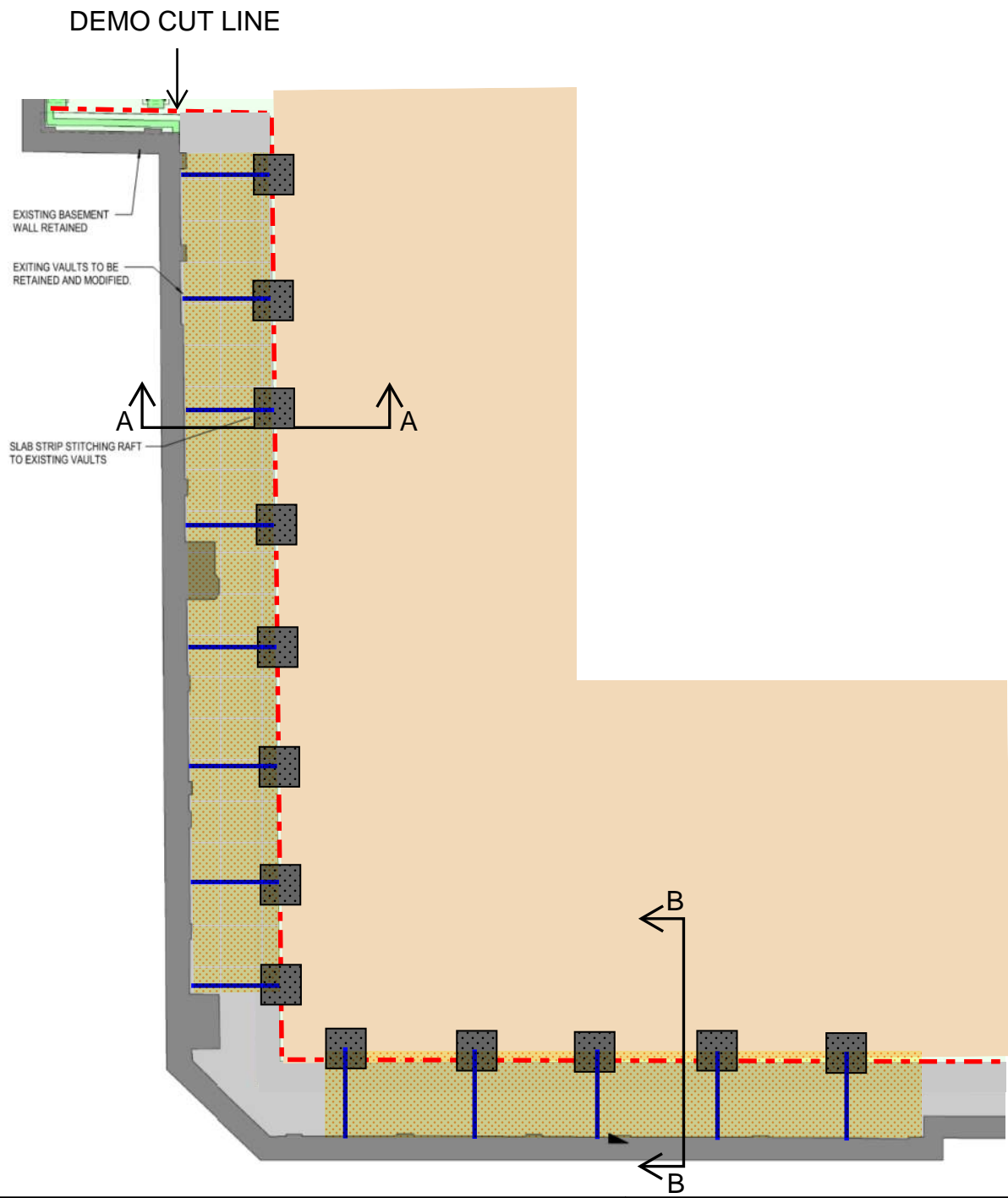

PROJECT TITLE

SKETCH TITLE

SKETCH No.

DRAWN

DATE

SCALE

REV.

McGEE
 A Specialist Engineering Contractor
 McGee Group (Holdings) Ltd
 Level 9 Alto Tower, 5 Hatfields
 London SE1 9PG
 Tel: 020 8998 1101 Fax: 020 8997 7690

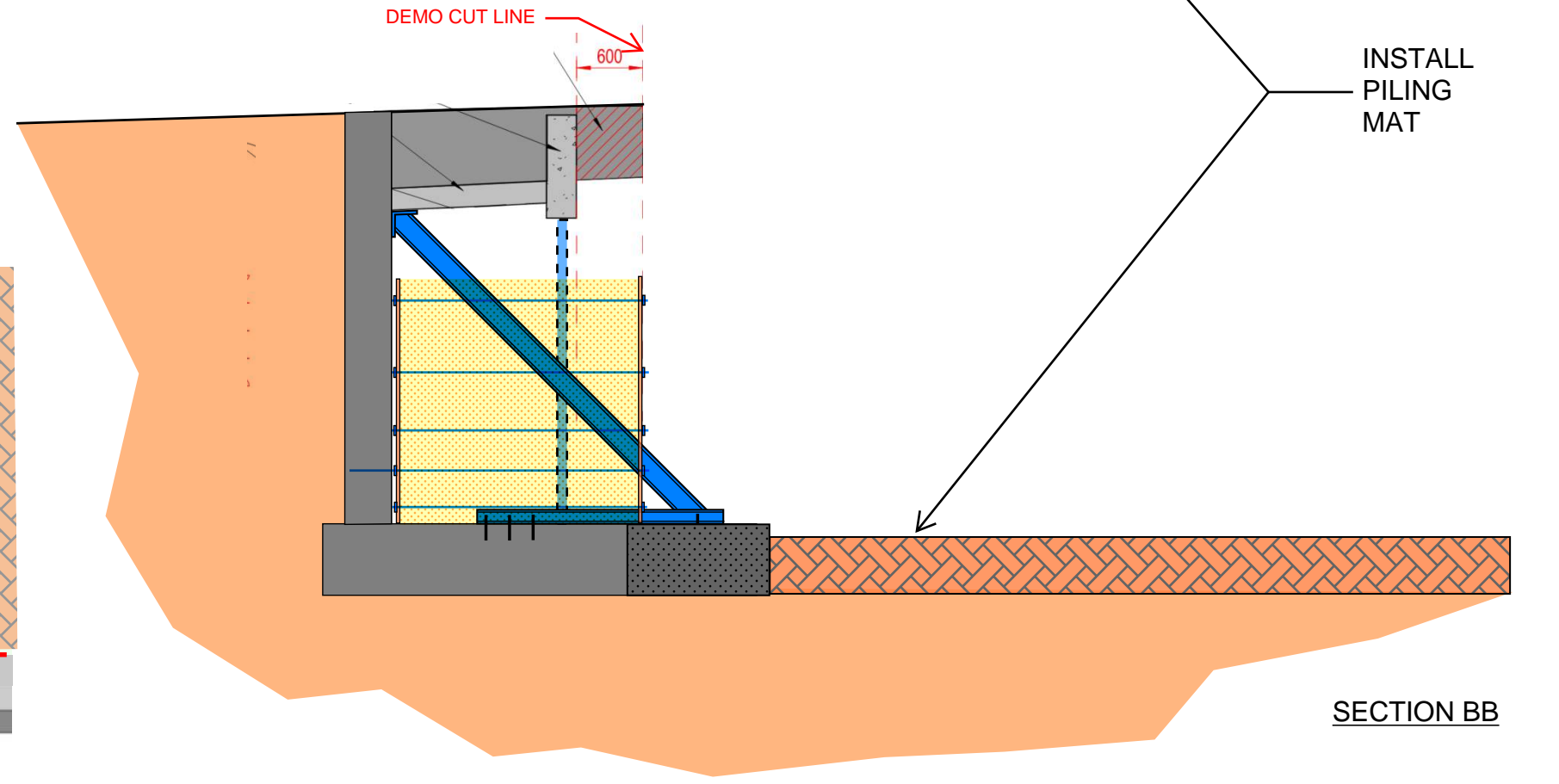
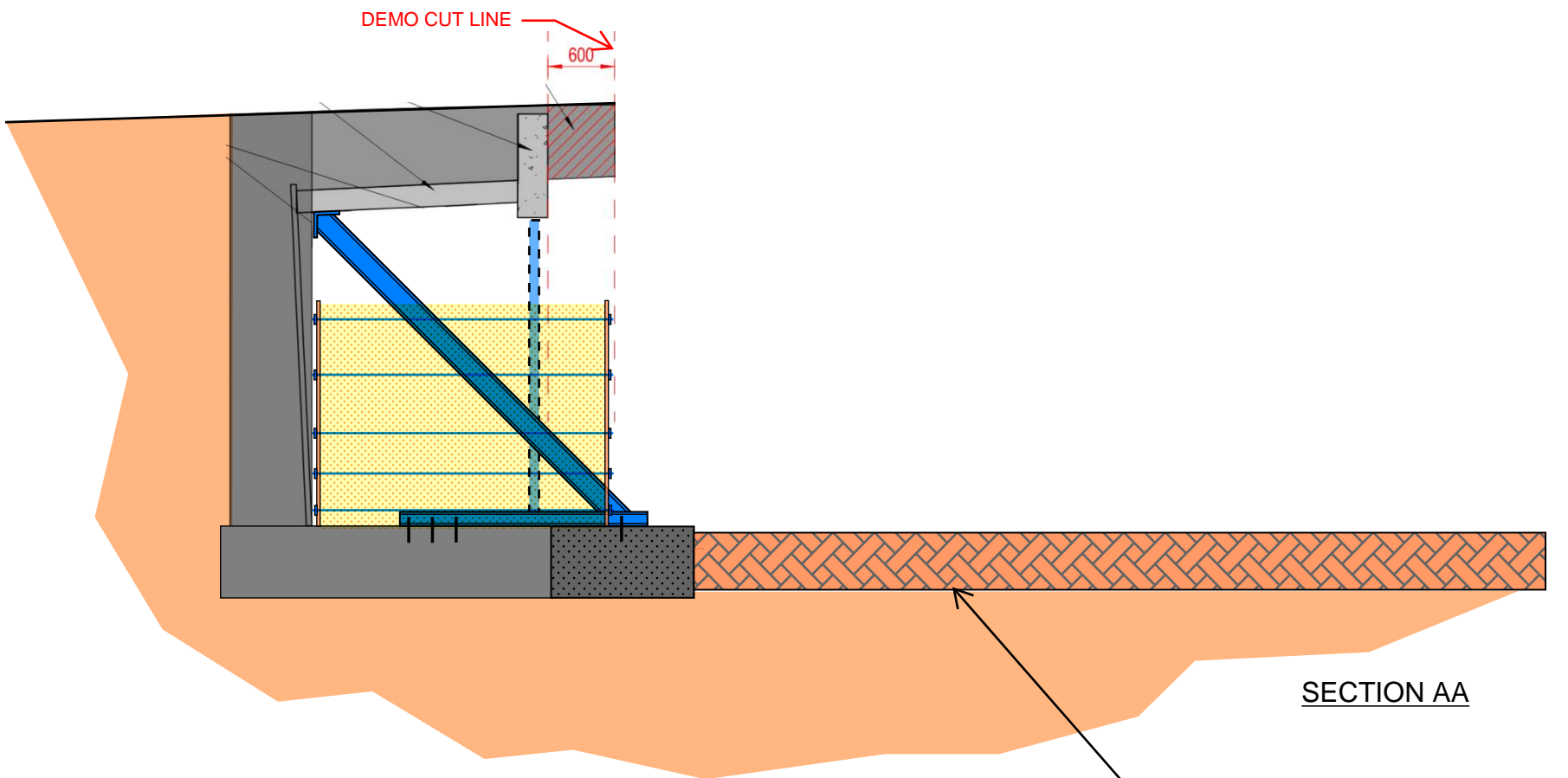
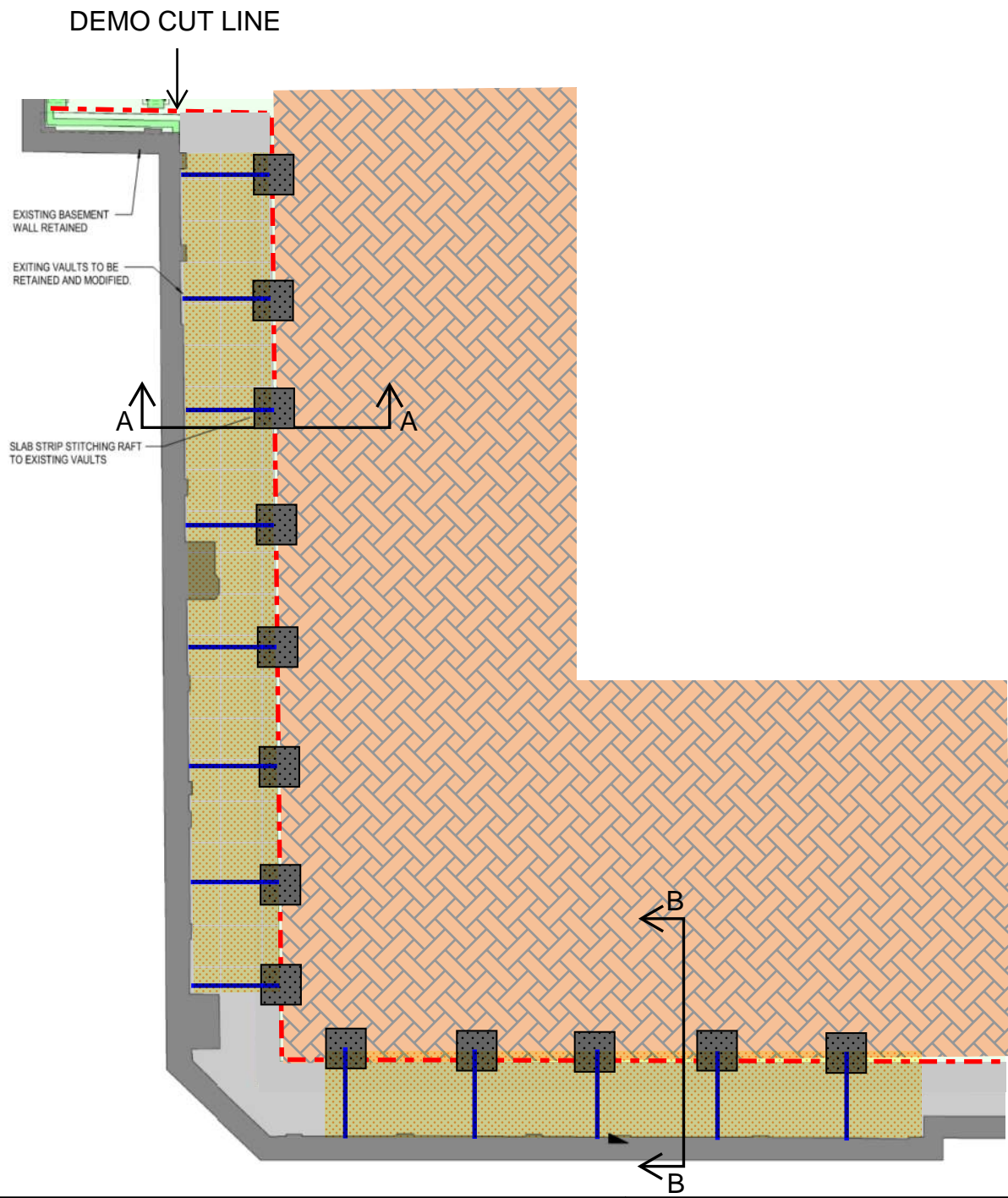

SECTION AA

INSTALL PILING MAT

SECTION BB

PROJECT TITLE

SKETCH TITLE

SKETCH No.

DRAWN

DATE

SCALE

REV.

McGEE
 A Specialist Engineering Contractor
 McGee Group (Holdings) Ltd
 Level 9 Alto Tower, 5 Hatfields
 London SE1 9PG
 Tel: 020 8998 1101 Fax: 020 8997 7690

DEMOLITION TENDER

BASEMENT VAULTS - EAST

50 ON ORIGINAL - A3

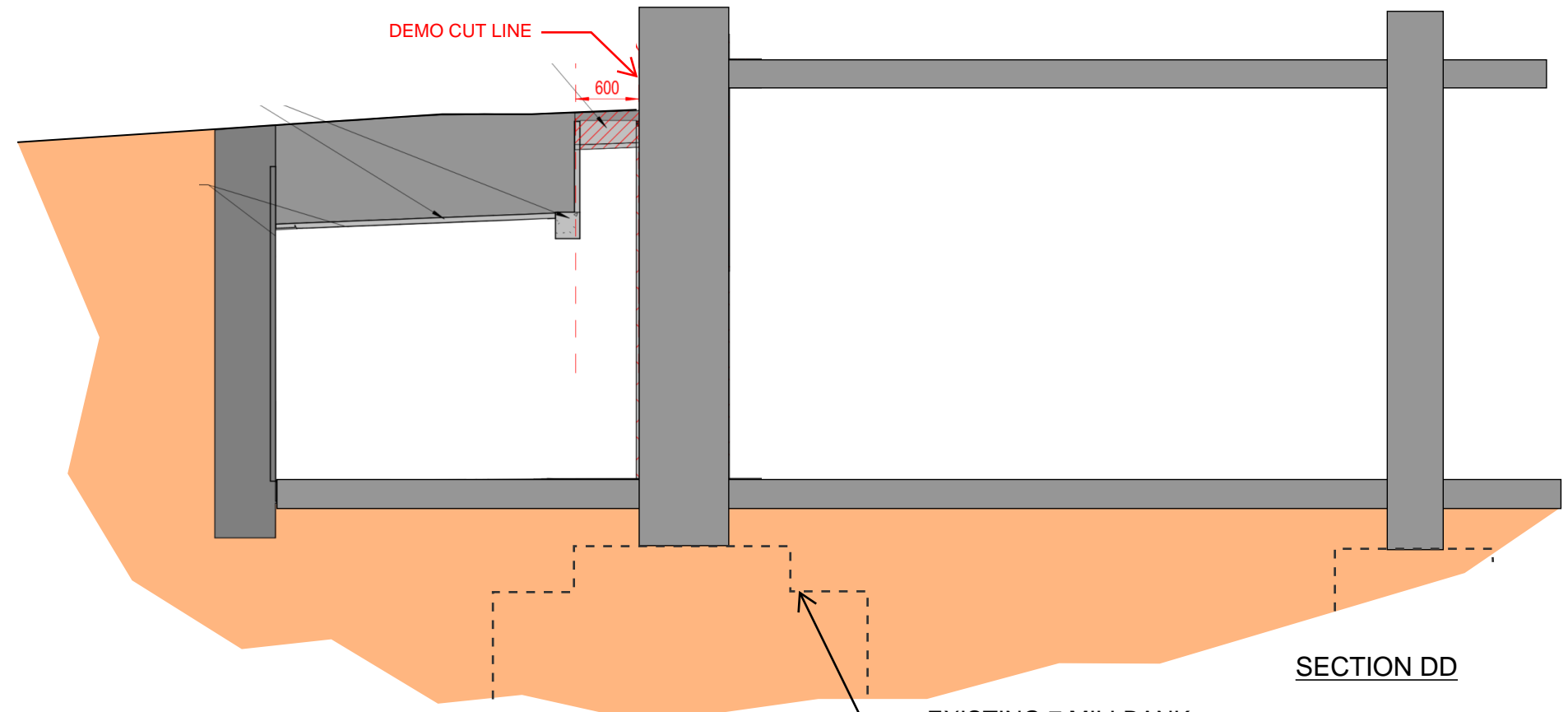
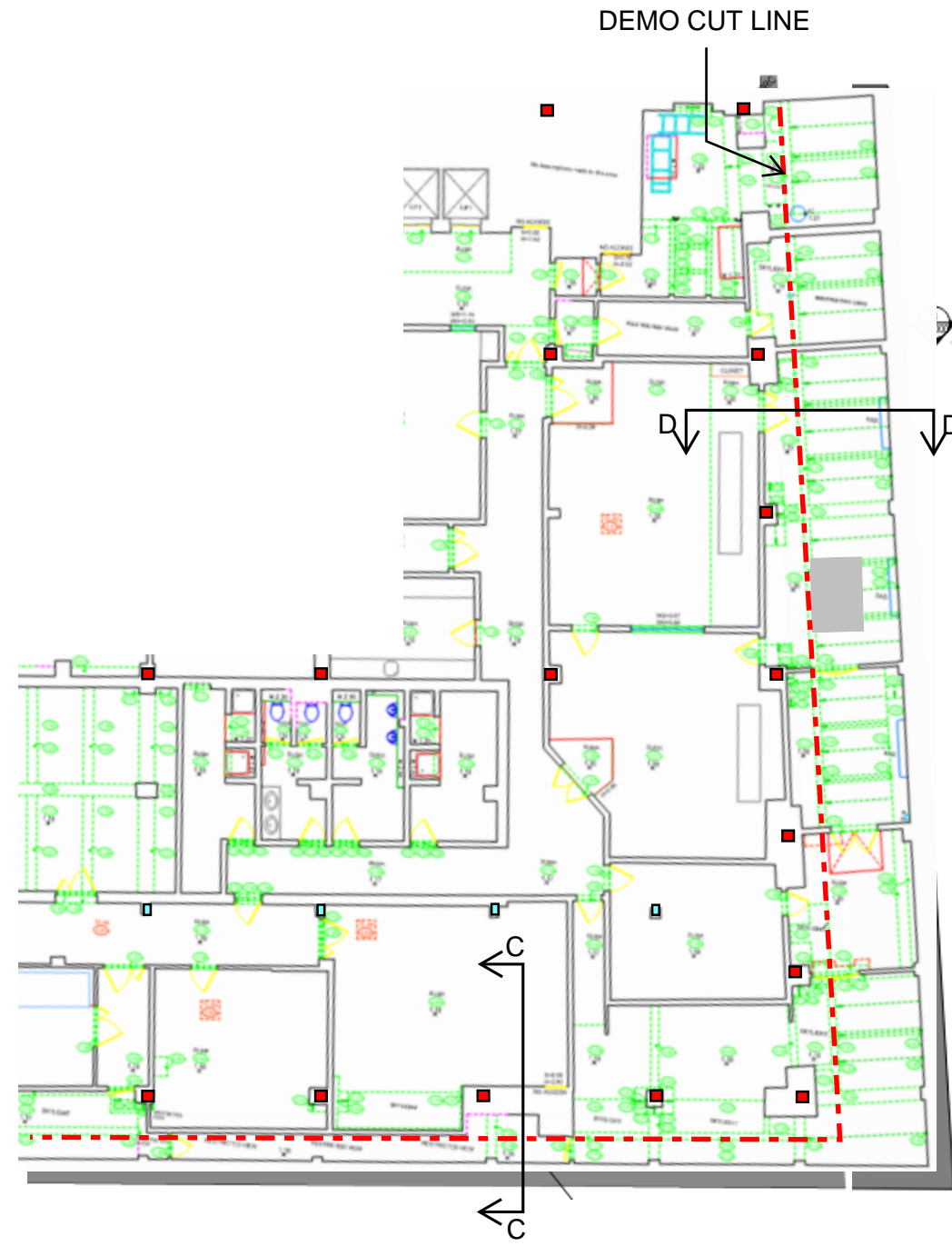

SECTION DD

EXISTING 7 MILLBANK
PAD FOUNDATIONS SHOWN
INDICATIVELY BASED ON
HISTORIC DRAWINGS

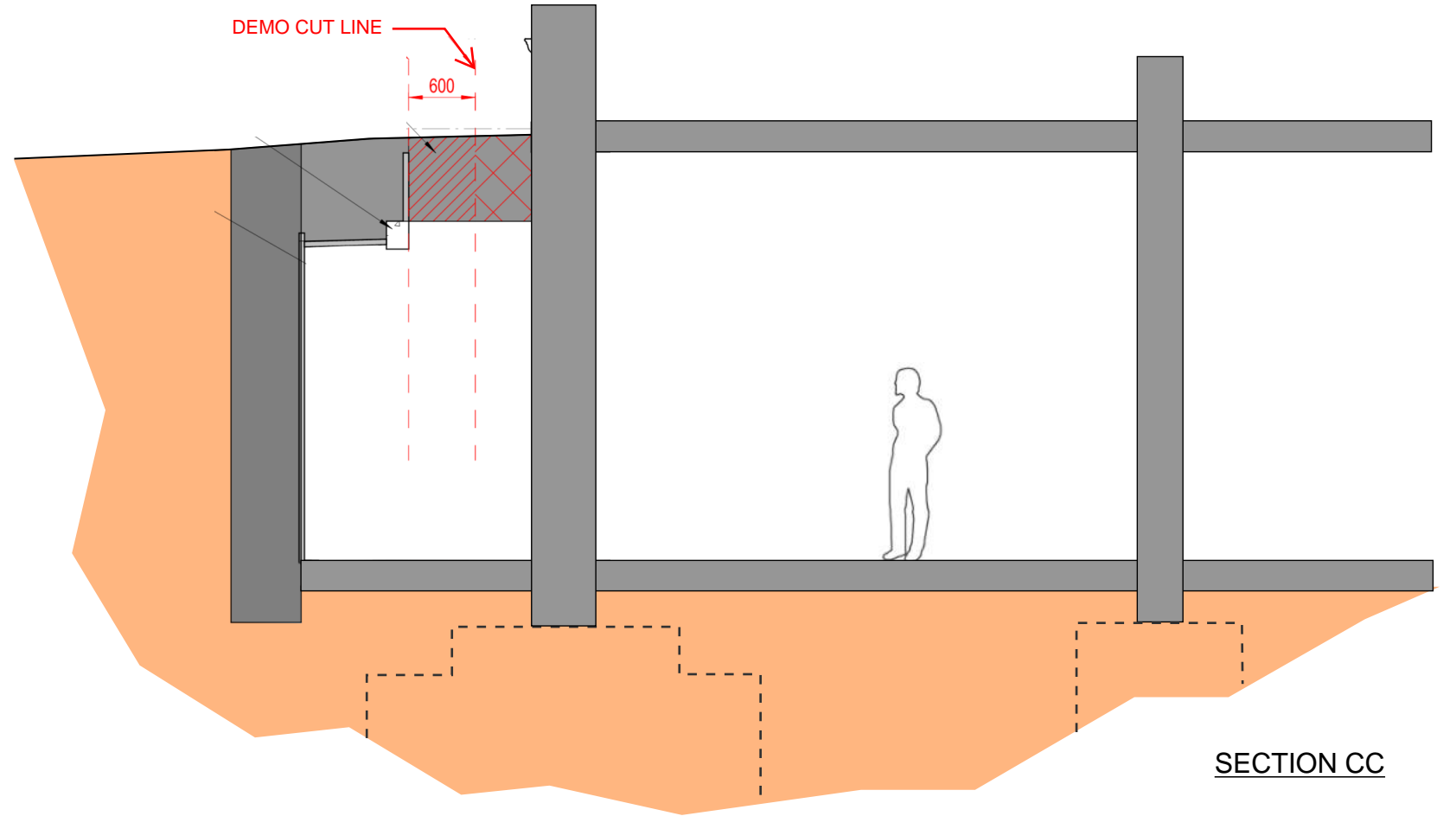

SECTION CC

PROJECT TITLE	SKETCH TITLE	SKETCH No.	DRAWN	DATE	 <p>McGEE A Specialist Engineering Contractor McGee Group (Holdings) Ltd Level 9 Alto Tower, 5 Hatfields London SE1 9PG Tel: 020 8998 1101 Fax: 020 8997 7690</p>
			SCALE	REV.	

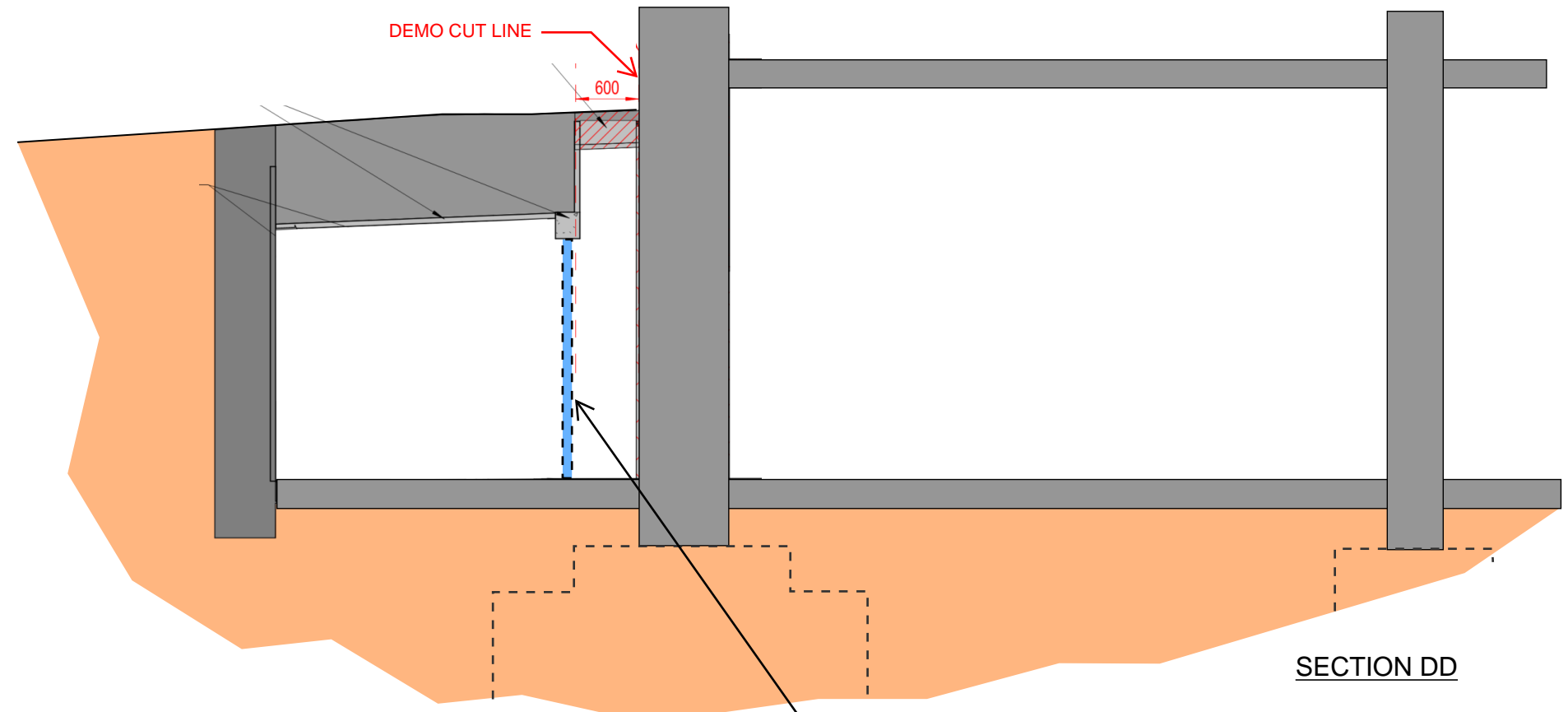
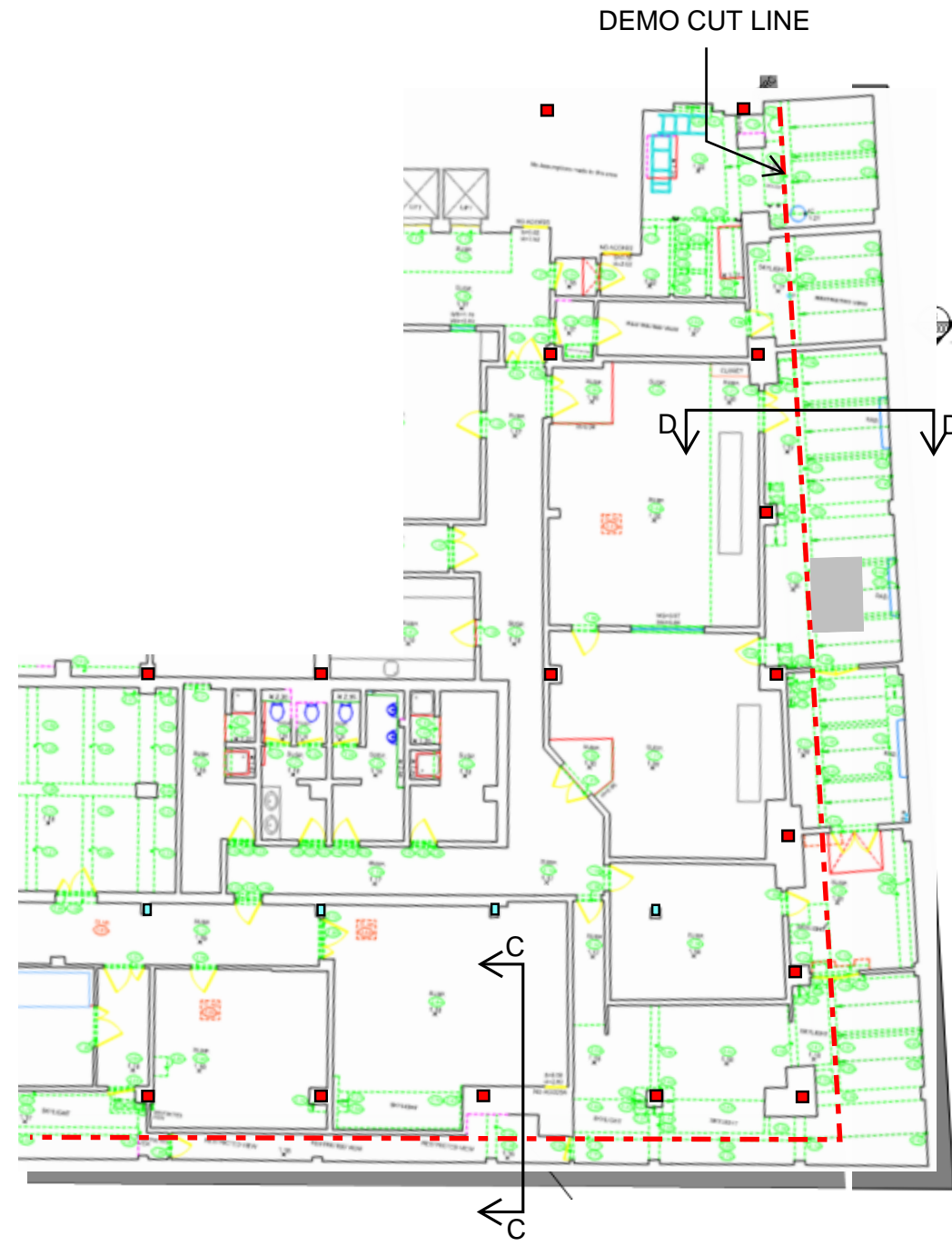

PROPRIETARY BACKPROPPING THROUGHOUT VAULTS AT 2m C/C TO SUPPORT VERTICAL S/W OF PAVEMENT, VAULT AND SCAFFOLDING.

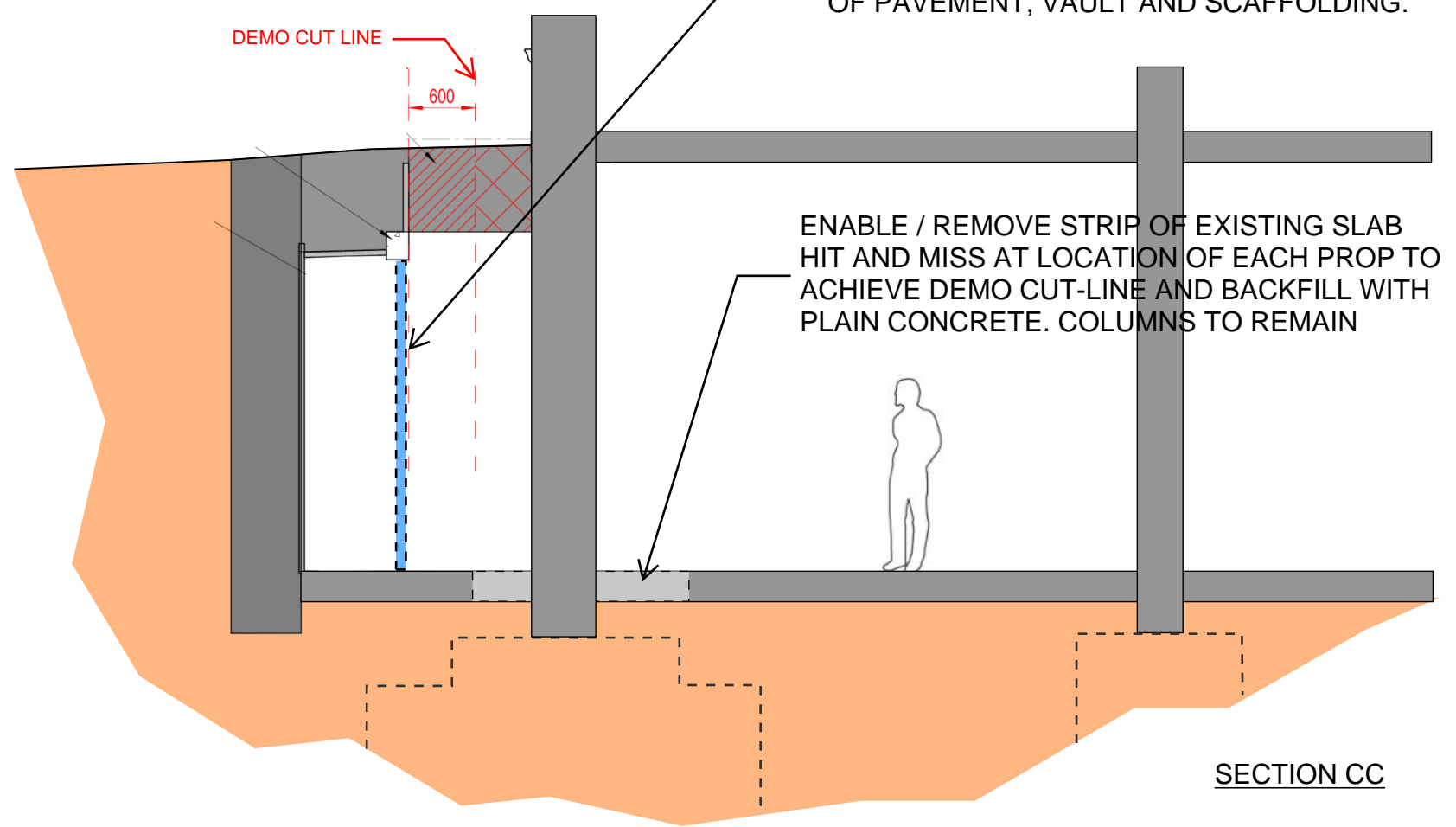

ENABLE / REMOVE STRIP OF EXISTING SLAB HIT AND MISS AT LOCATION OF EACH PROP TO ACHIEVE DEMO CUT-LINE AND BACKFILL WITH PLAIN CONCRETE. COLUMNS TO REMAIN

PROJECT TITLE	SKETCH TITLE	SKETCH No.	DRAWN	DATE	 <p>McGEE A Specialist Engineering Contractor McGee Group (Holdings) Ltd Level 9 Alto Tower, 5 Hatfields London SE1 9PG Tel: 020 8998 1101 Fax: 020 8997 7690</p>
			SCALE	REV.	

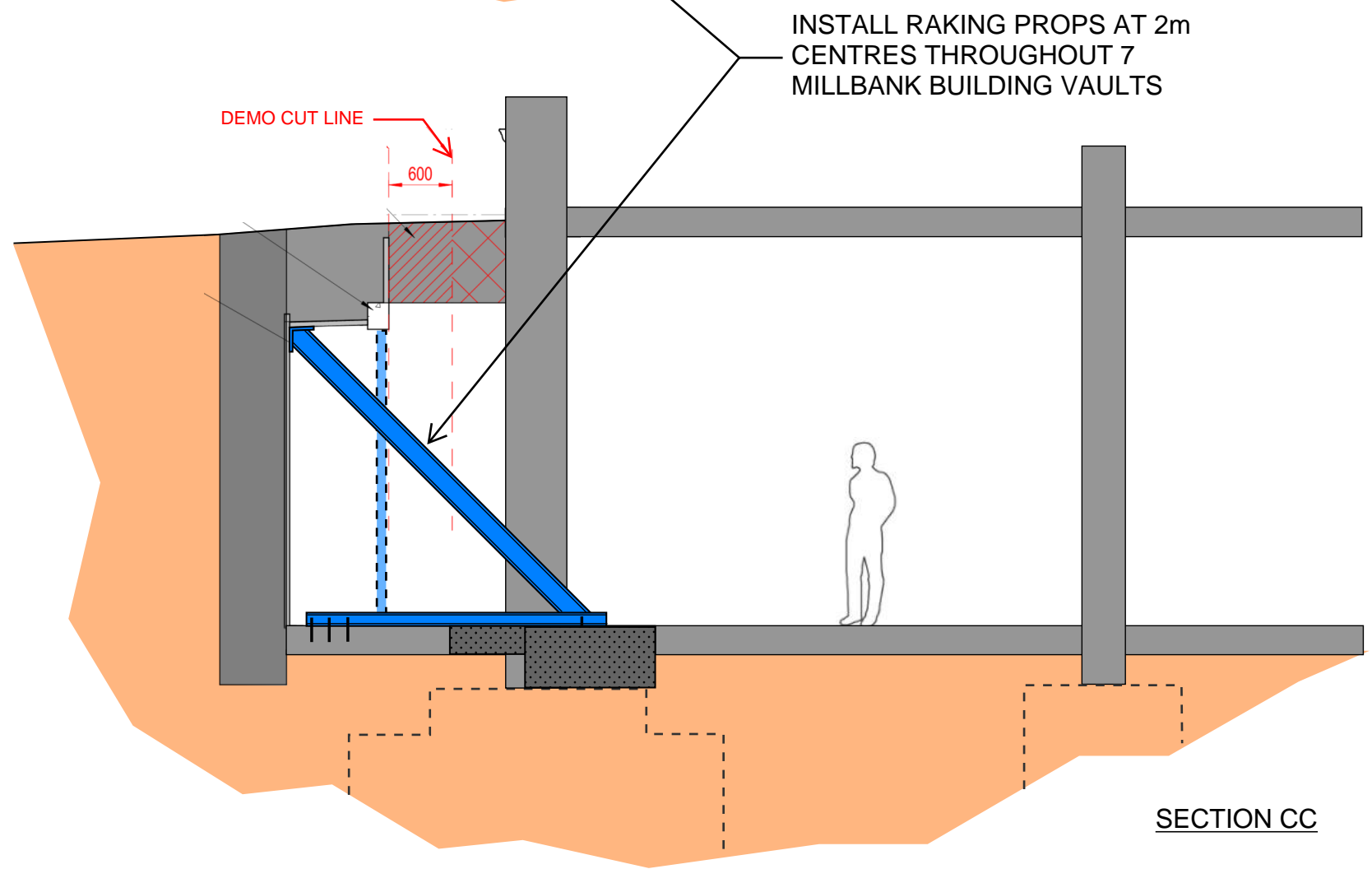
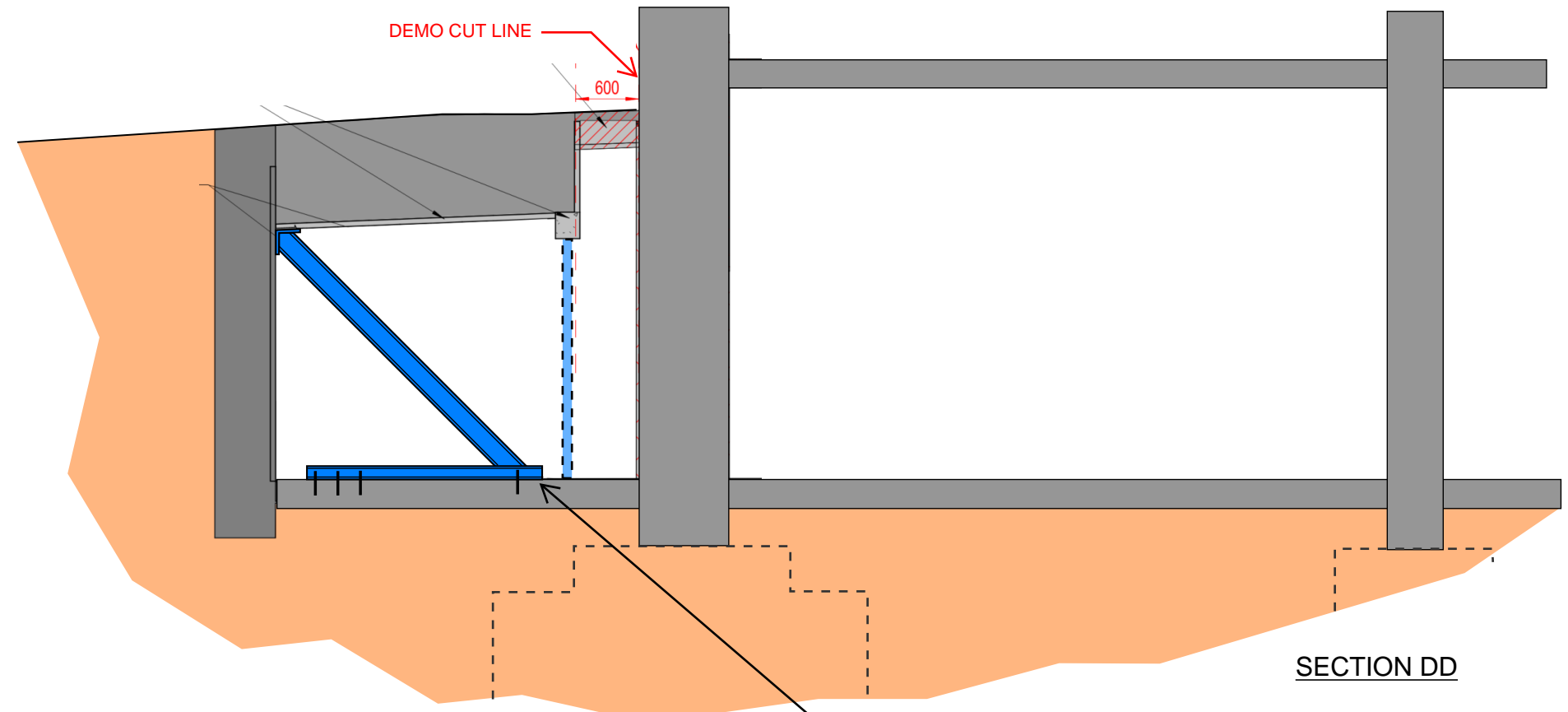
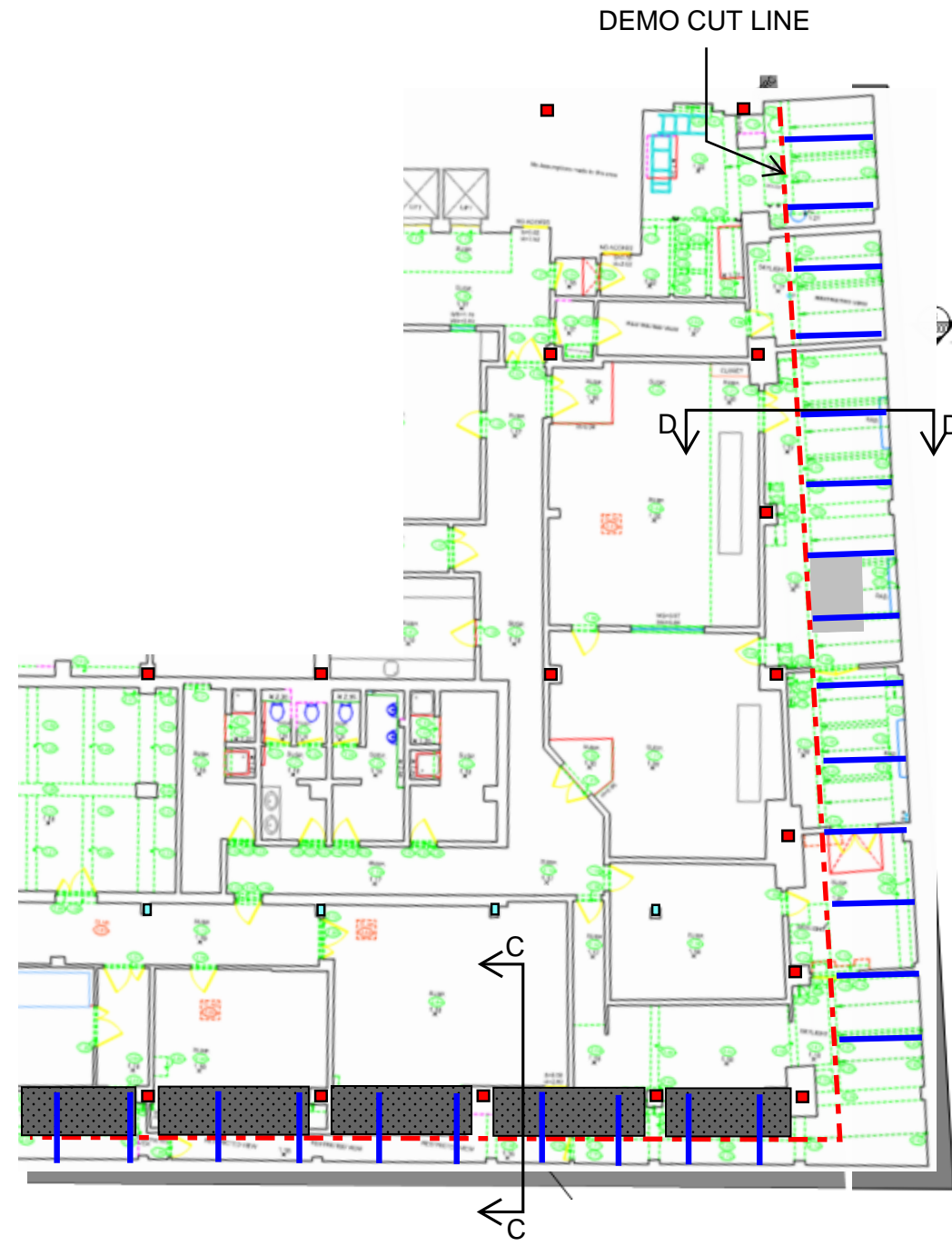

INSTALL RAKING PROPS AT 2m CENTRES THROUGHOUT 7 MILLBANK BUILDING VAULTS

PROJECT TITLE	SKETCH TITLE	SKETCH No.	DRAWN	DATE	 <p>McGEE A Specialist Engineering Contractor McGee Group (Holdings) Ltd Level 9 Alto Tower, 5 Hatfields London SE1 9PG Tel: 020 8998 1101 Fax: 020 8997 7690</p>
			SCALE	REV.	

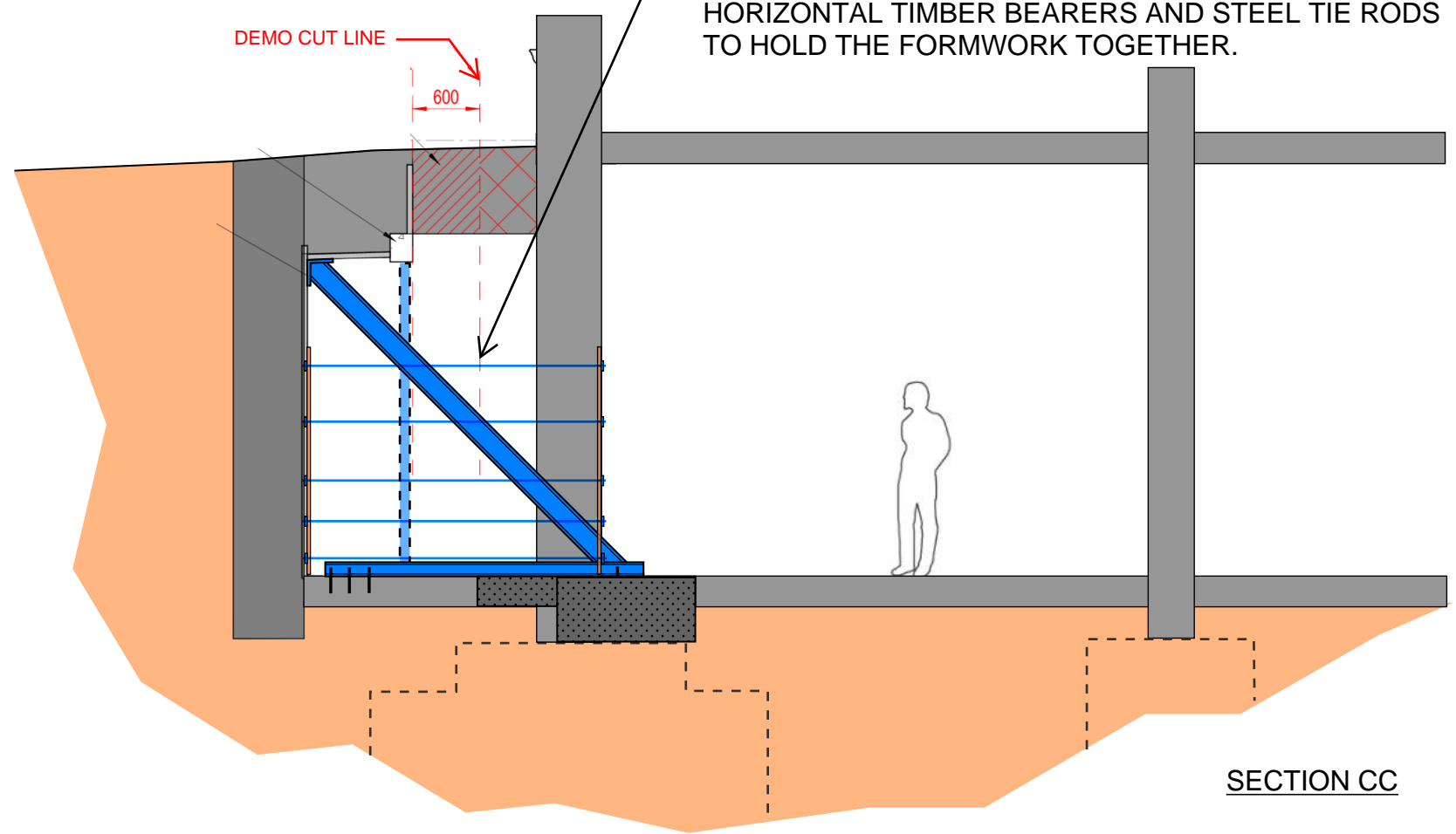
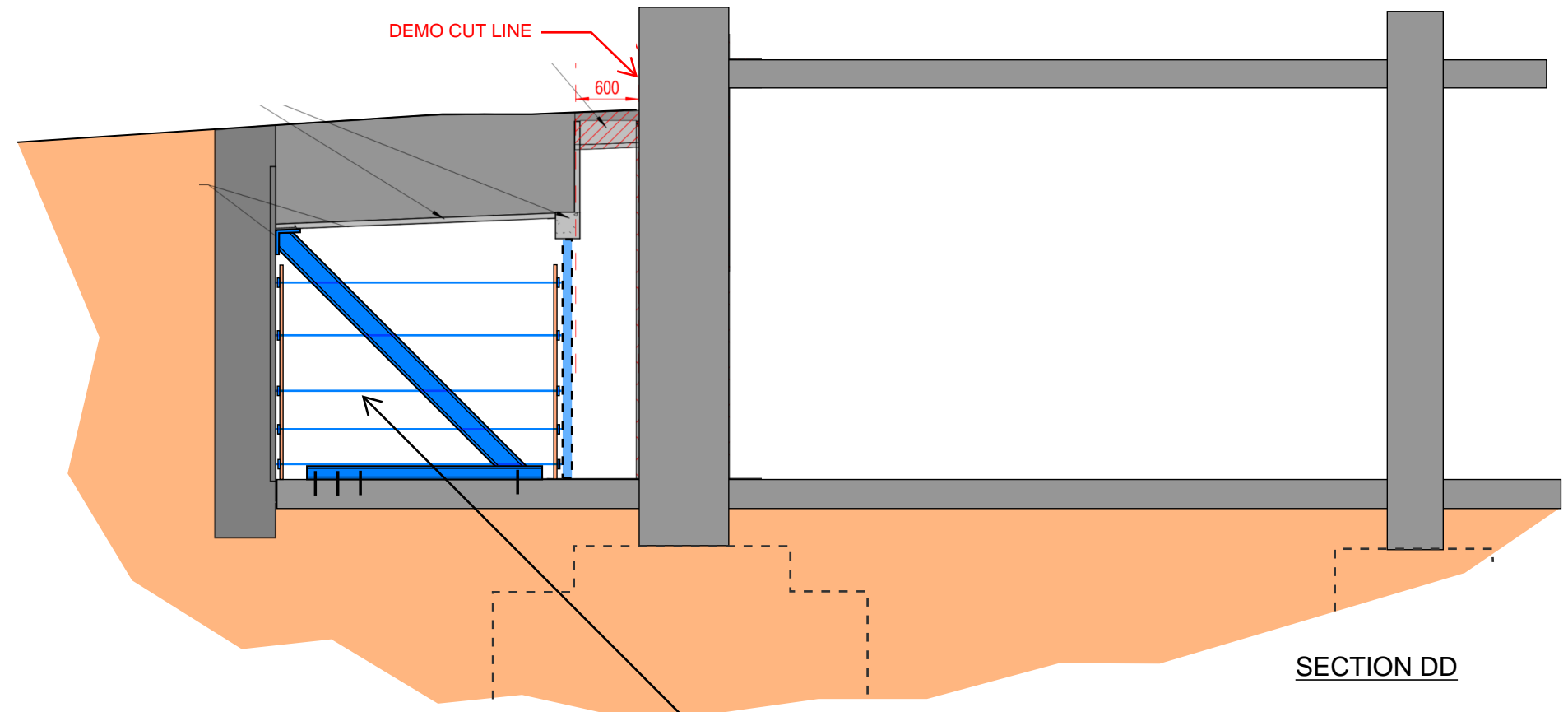
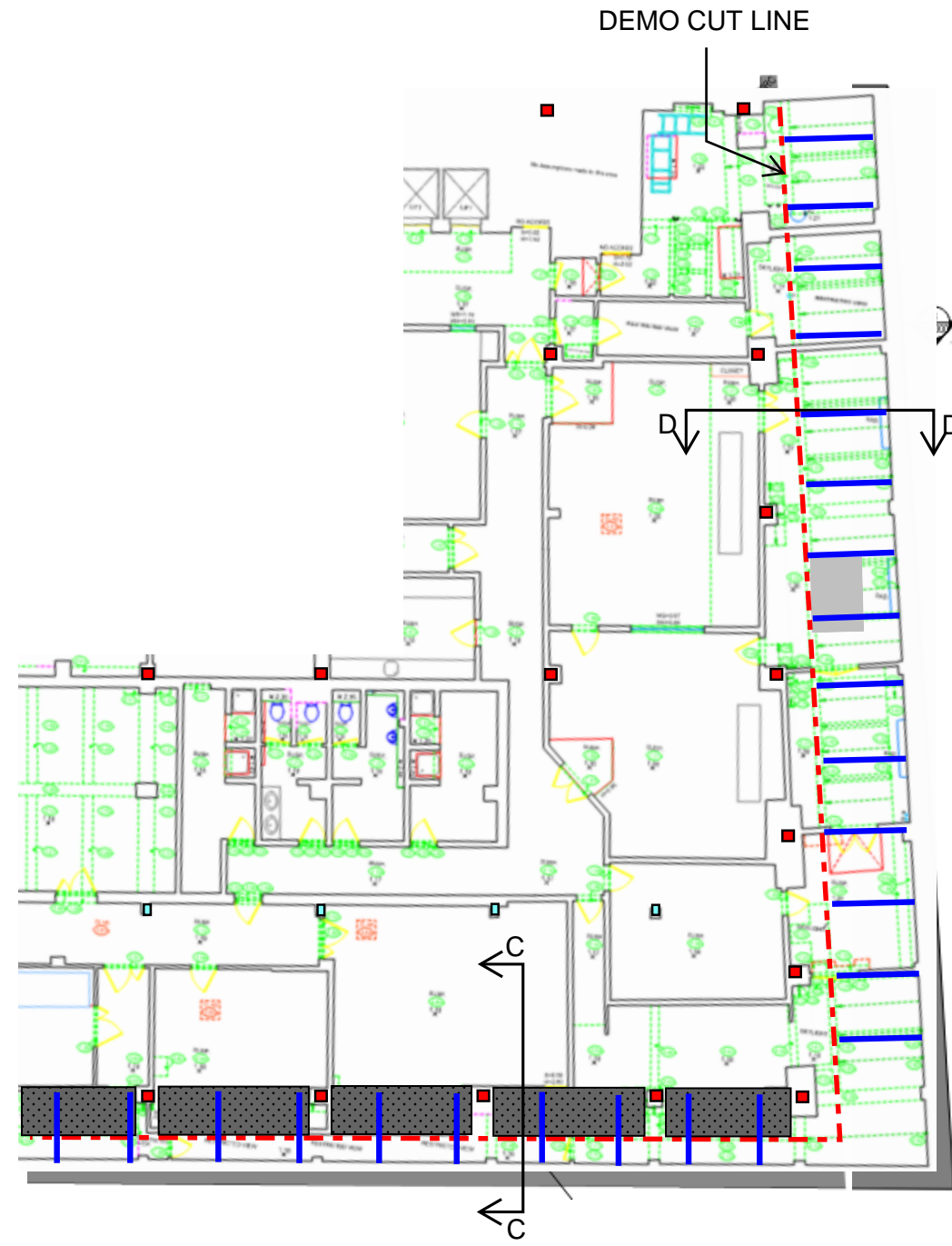

INSTALL FORMWORK FOR SAND TO BE
POURED/PUMPED IN FROM STREET LEVEL THROUGH
THE PAVEMENT LIGHTS. PLYWOOD FORMWORK WITH
HORIZONTAL TIMBER BEARERS AND STEEL TIE RODS
TO HOLD THE FORMWORK TOGETHER.

PROJECT TITLE	SKETCH TITLE	SKETCH No.	DRAWN	DATE	 <p>McGEE A Specialist Engineering Contractor McGee Group (Holdings) Ltd Level 9 Alto Tower, 5 Hatfields London SE1 9PG Tel: 020 8998 1101 Fax: 020 8997 7690</p>
			SCALE	REV.	

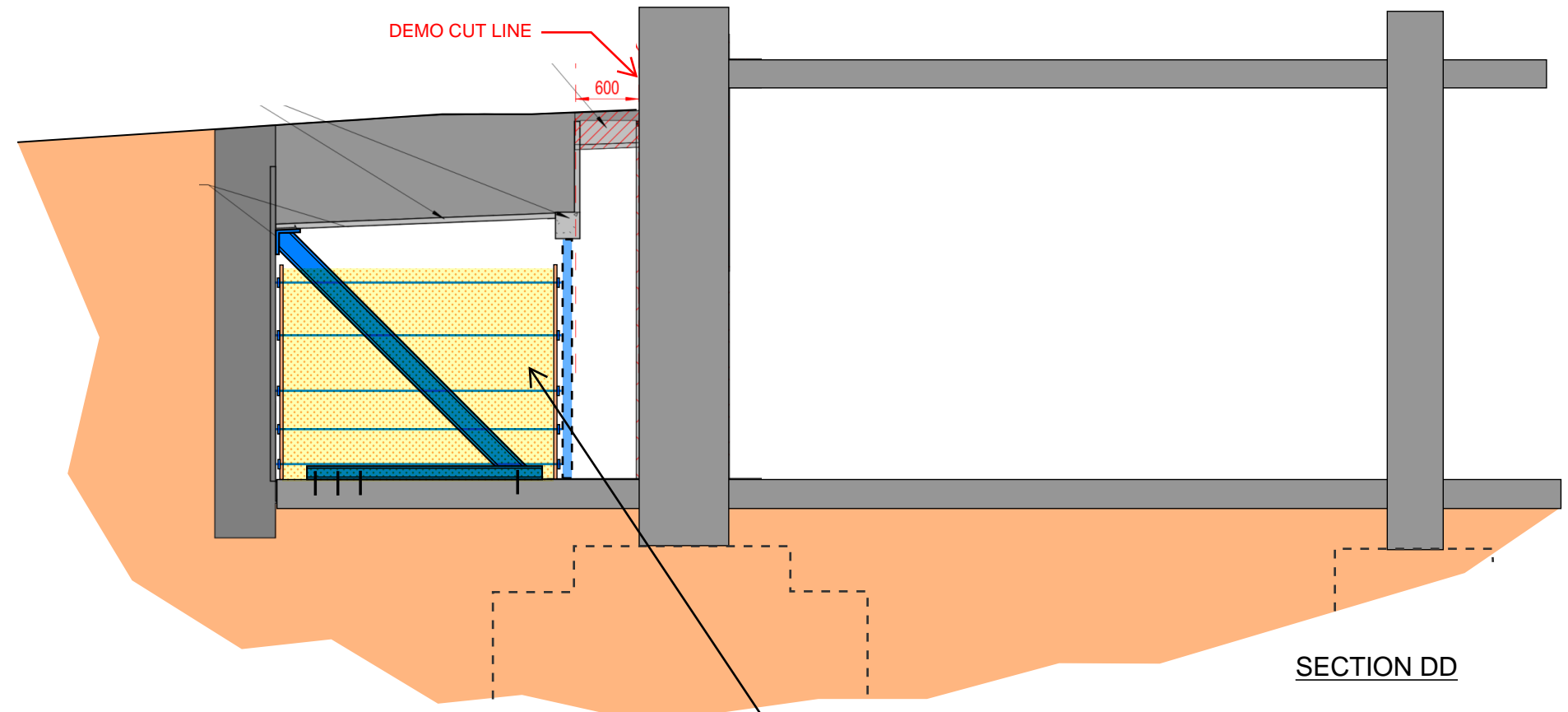
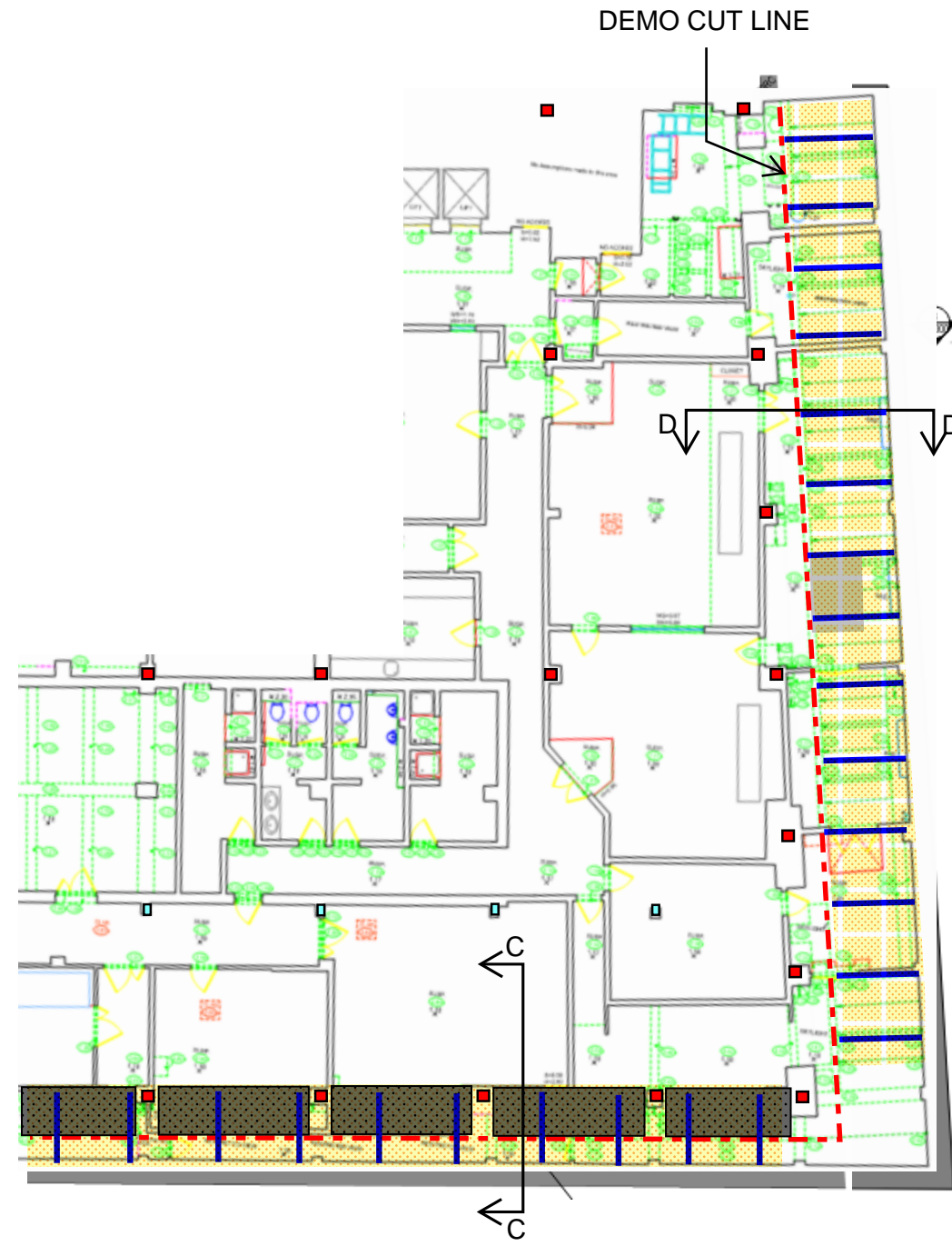

SECTION DD

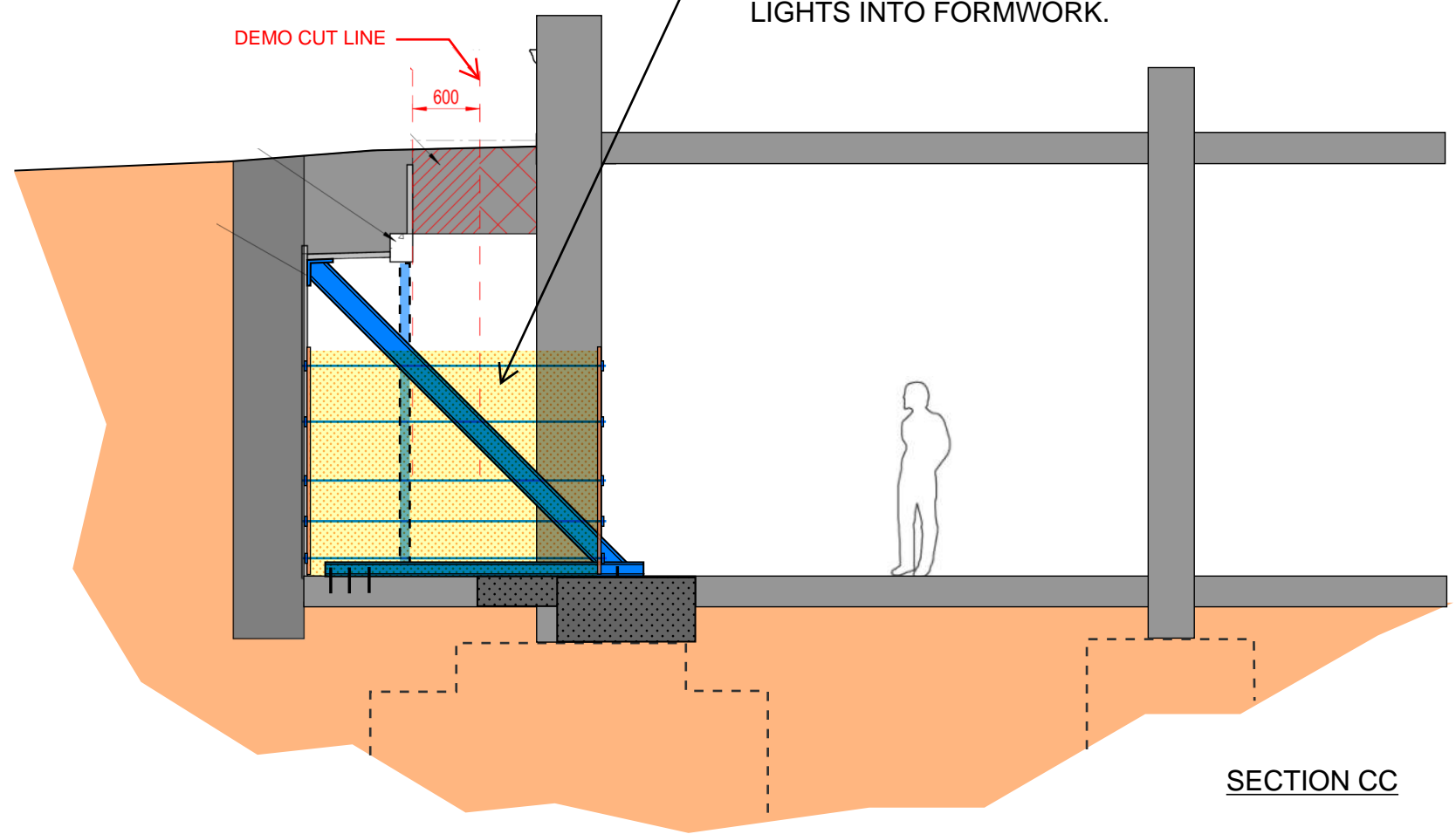

SECTION CC

PROJECT TITLE	SKETCH TITLE
---------------	--------------

SKETCH No.

DRAWN	DATE
SCALE	REV.

 <p>McGEE A Specialist Engineering Contractor</p> <p>McGee Group (Holdings) Ltd Level 9 Alto Tower, 5 Hatfields London SE1 9PG Tel: 020 8998 1101 Fax: 020 8997 7690</p>	
--	--

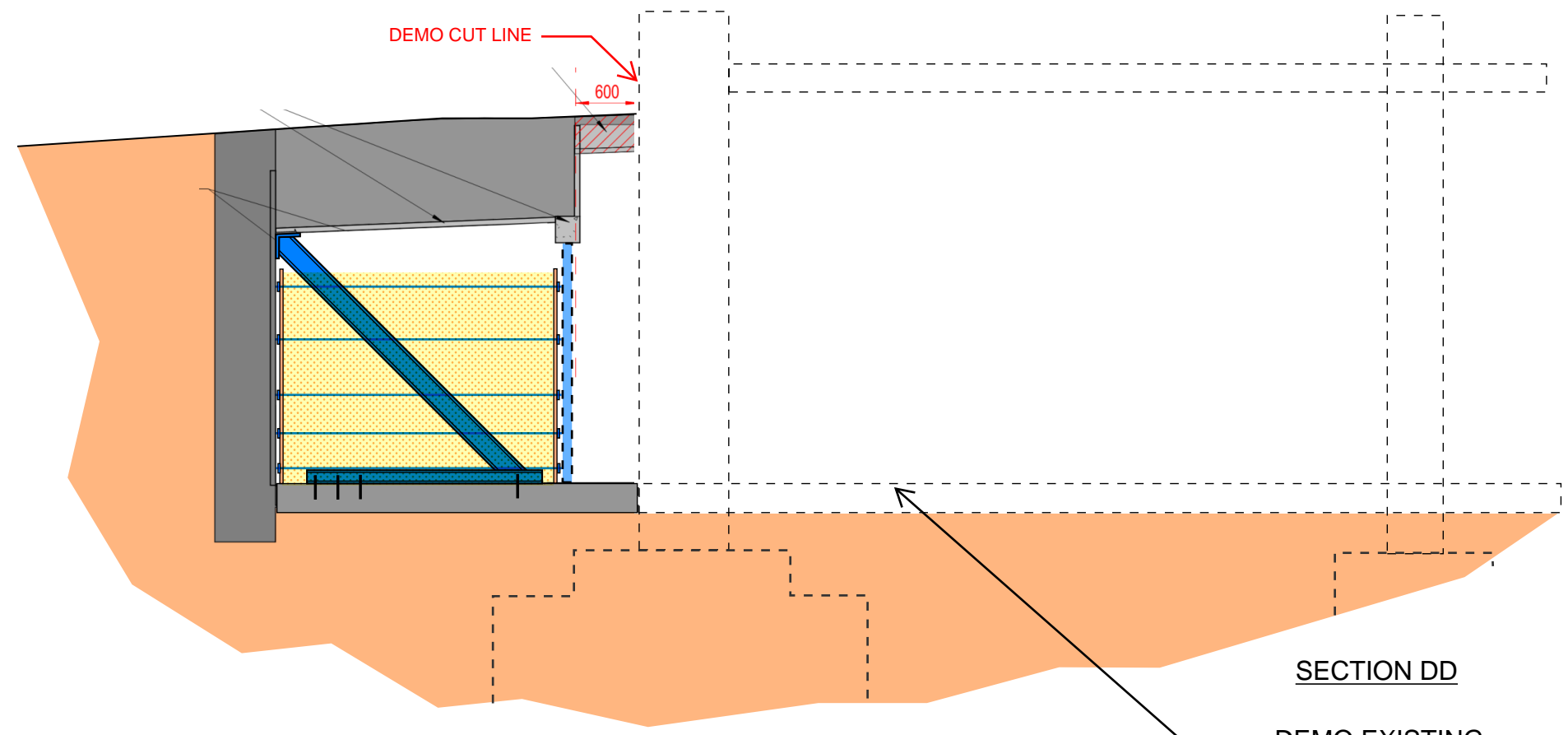
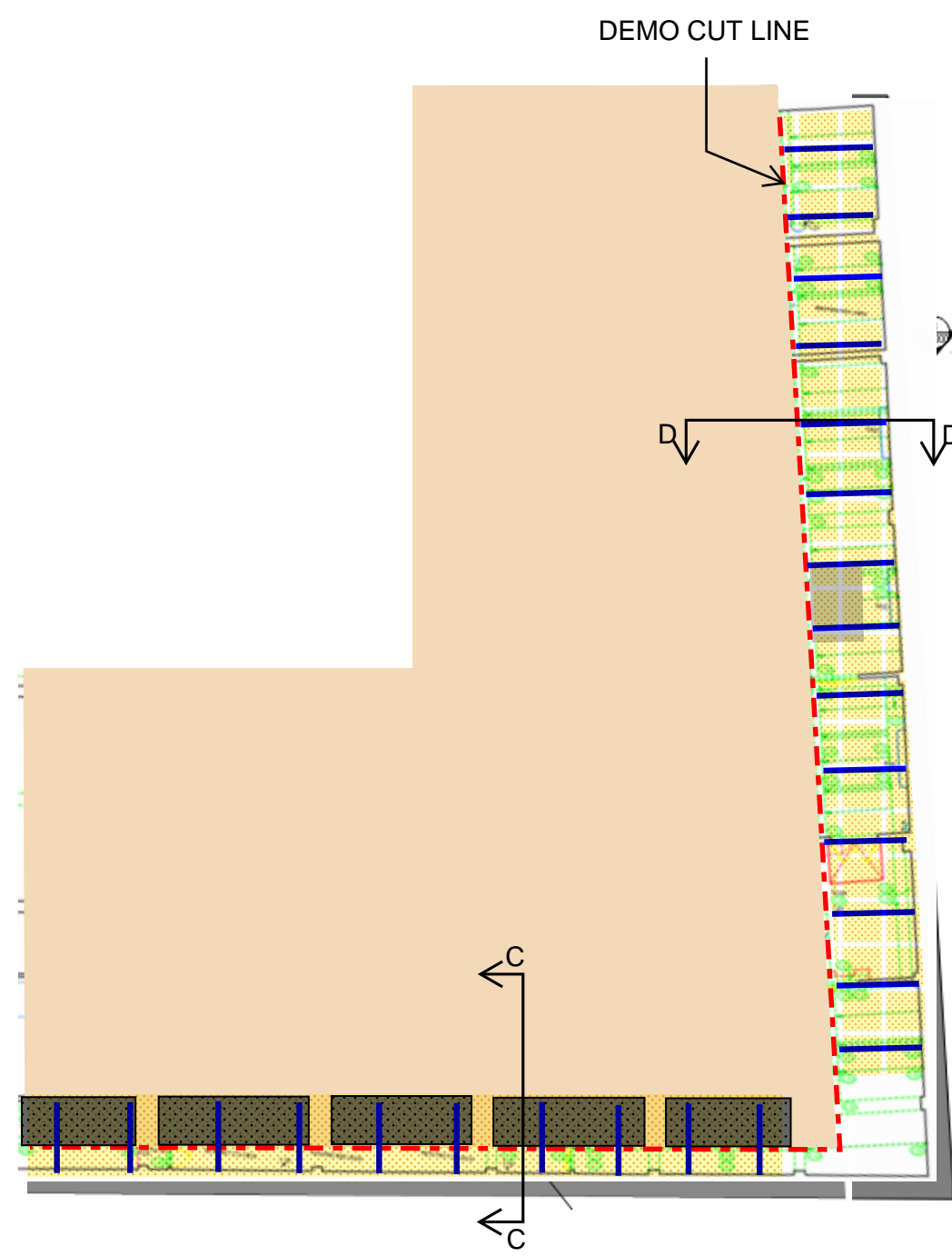

SECTION DD
 DEMO EXISTING
 STRUCTURE
 INCLUDING B1 SLAB

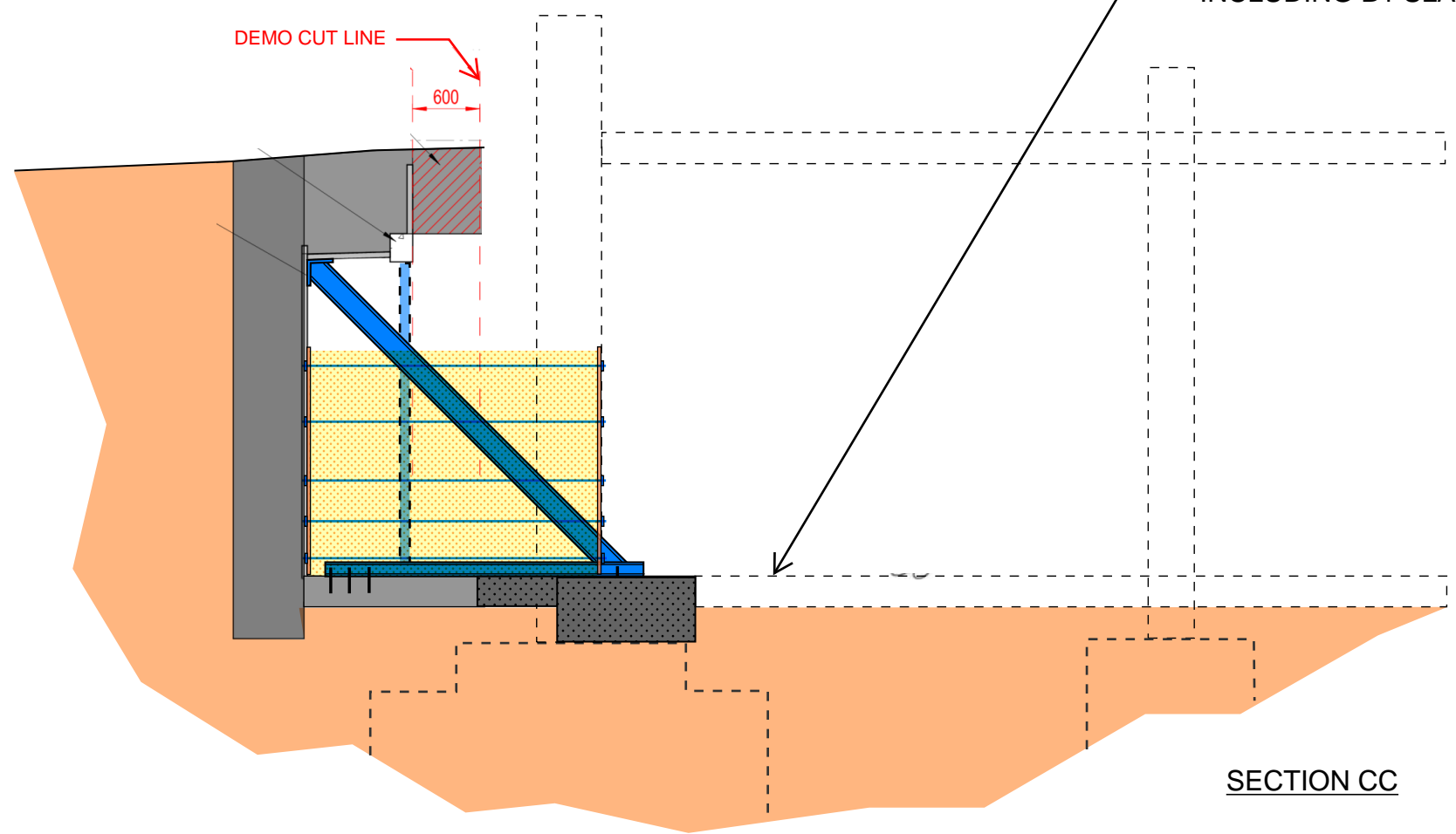

SECTION CC

PROJECT TITLE	SKETCH TITLE	SKETCH No.	DRAWN	DATE	 <p>McGEE A Specialist Engineering Contractor McGee Group (Holdings) Ltd Level 9 Alto Tower, 5 Hatfields London SE1 9PG Tel: 020 8998 1101 Fax: 020 8997 7690</p>
			SCALE	REV.	

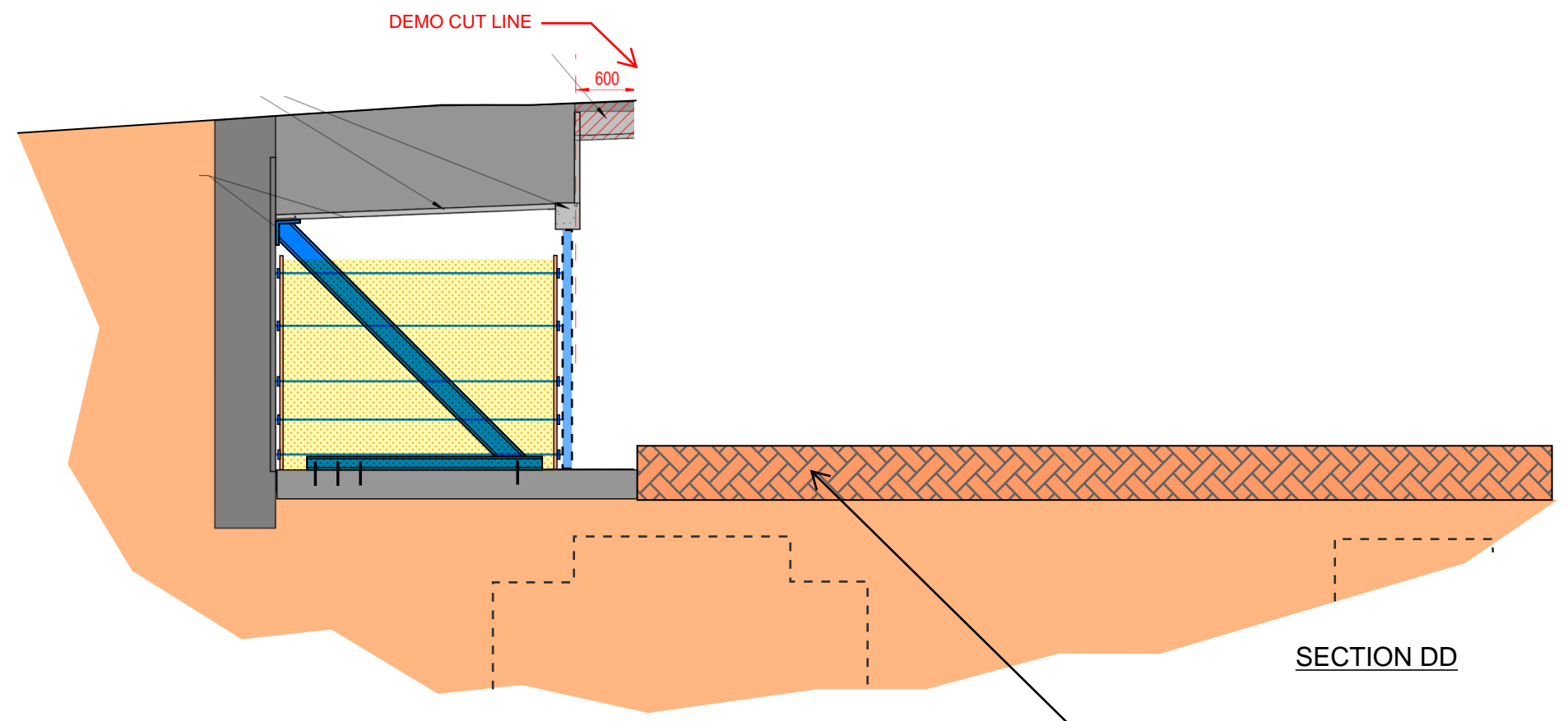
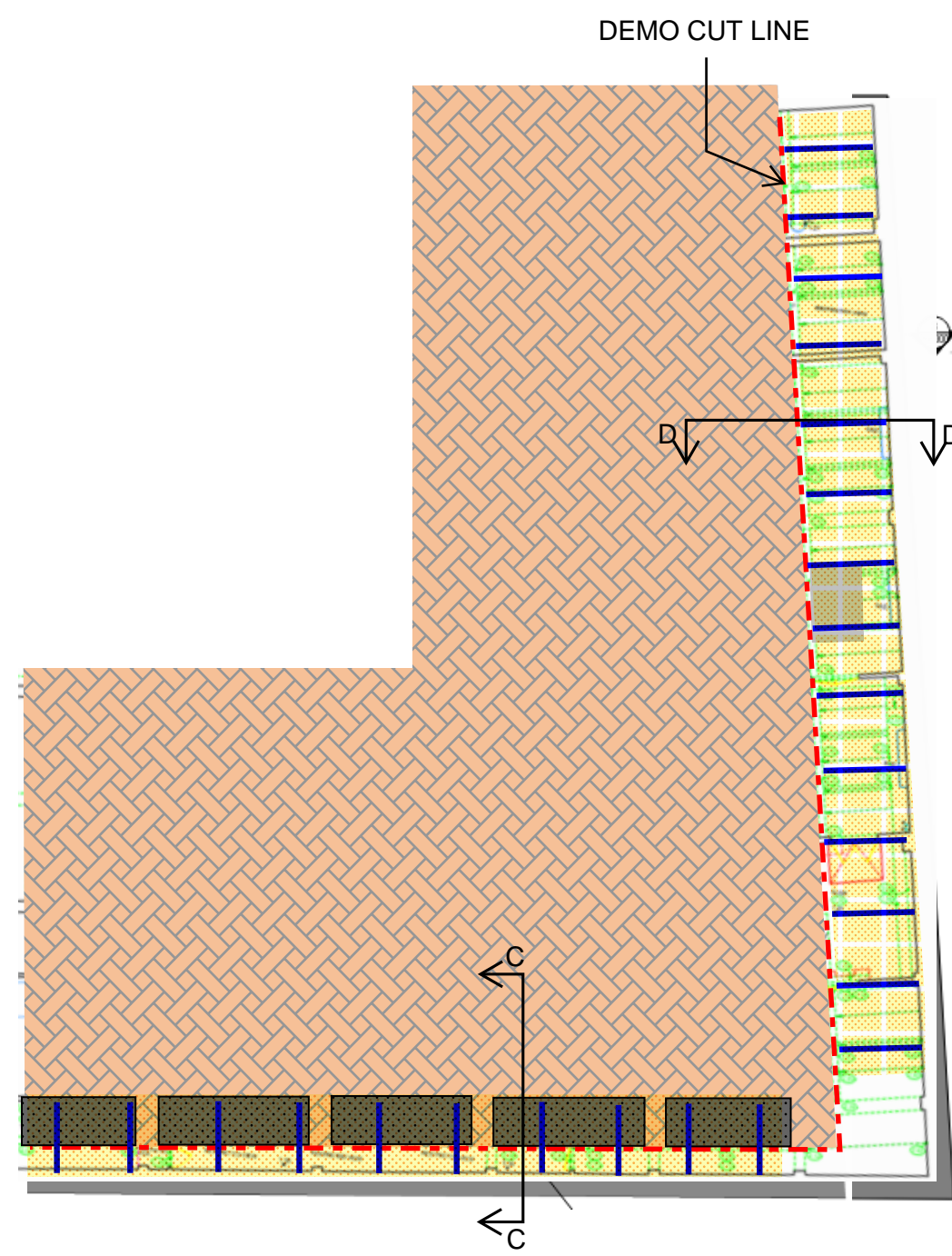

SECTION DD

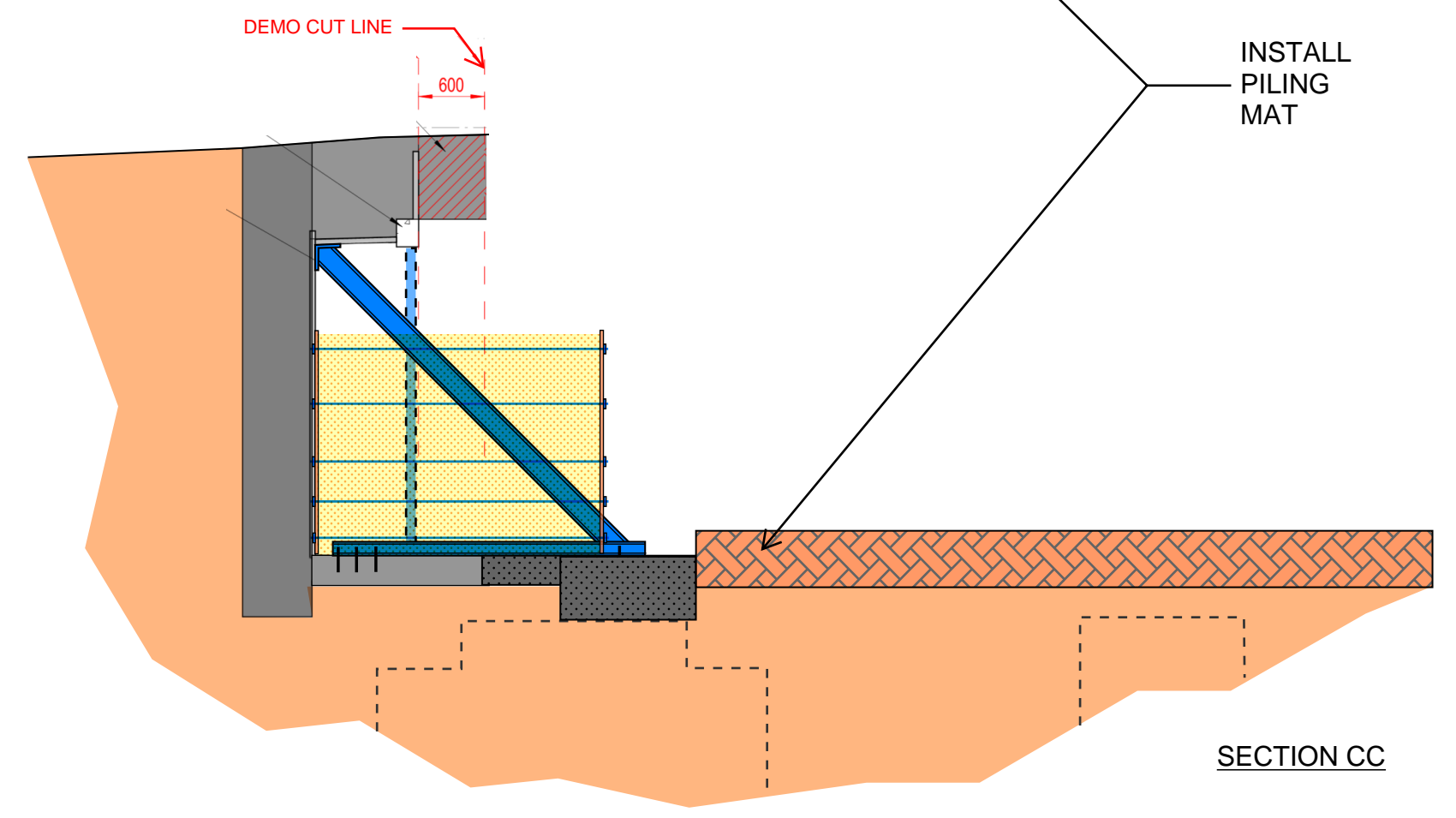

SECTION CC

INSTALL
PILING
MAT

PROJECT TITLE

SKETCH TITLE

SKETCH No.

DRAWN

DATE

SCALE

REV.

McGEE
A Specialist Engineering Contractor
McGee Group (Holdings) Ltd
Level 9 Alto Tower, 5 Hatfields
London SE1 9PG
Tel: 020 8998 1101 Fax: 020 8997 7690

INTEGRATED TENDER BASEMENT VAULTS - WEST

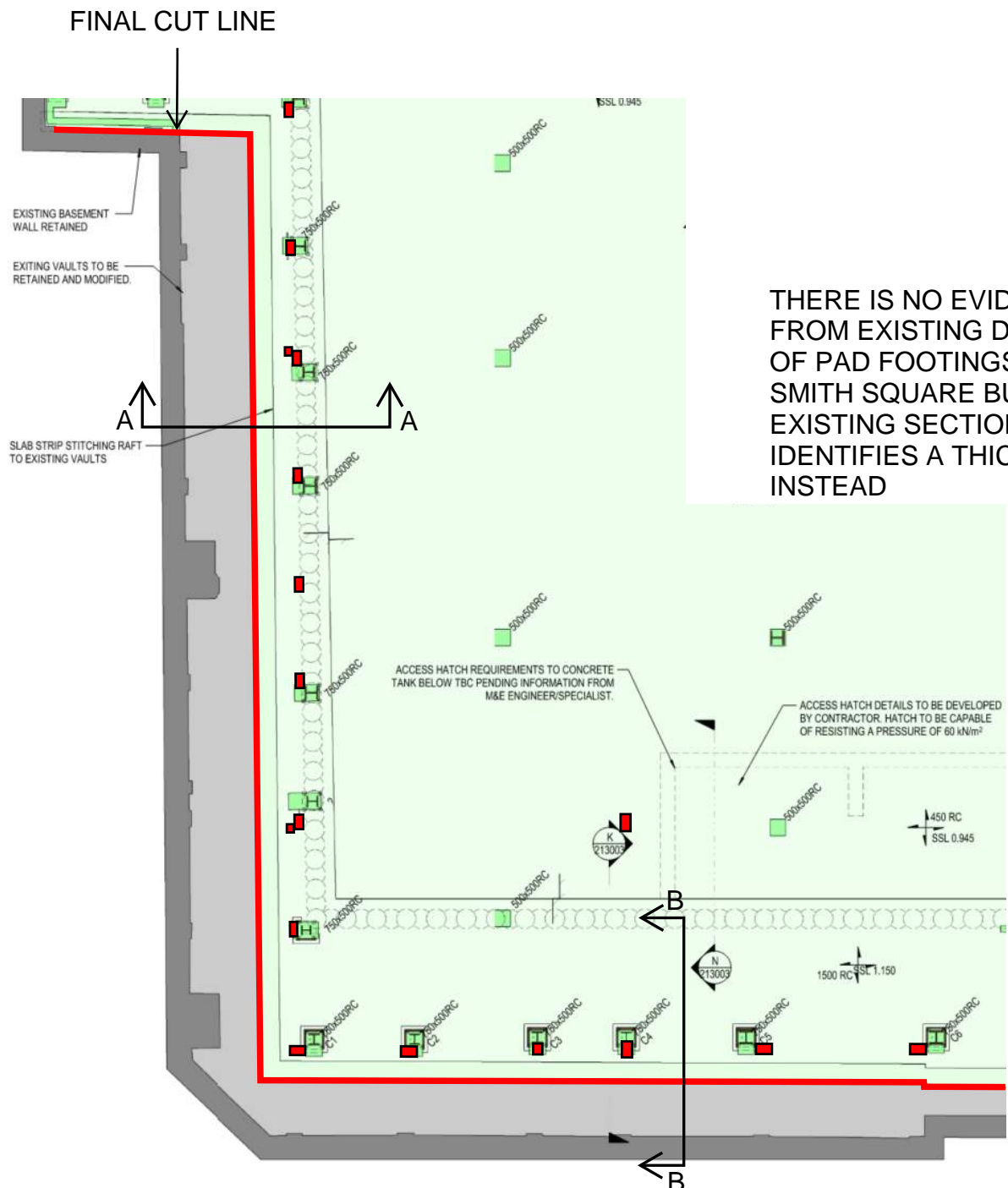

THERE IS NO EVIDENCE FROM EXISTING DRAWINGS OF PAD FOOTINGS BENEATH SMITH SQUARE BUILDING. EXISTING SECTIONS IDENTIFIES A THICK RAFT INSTEAD

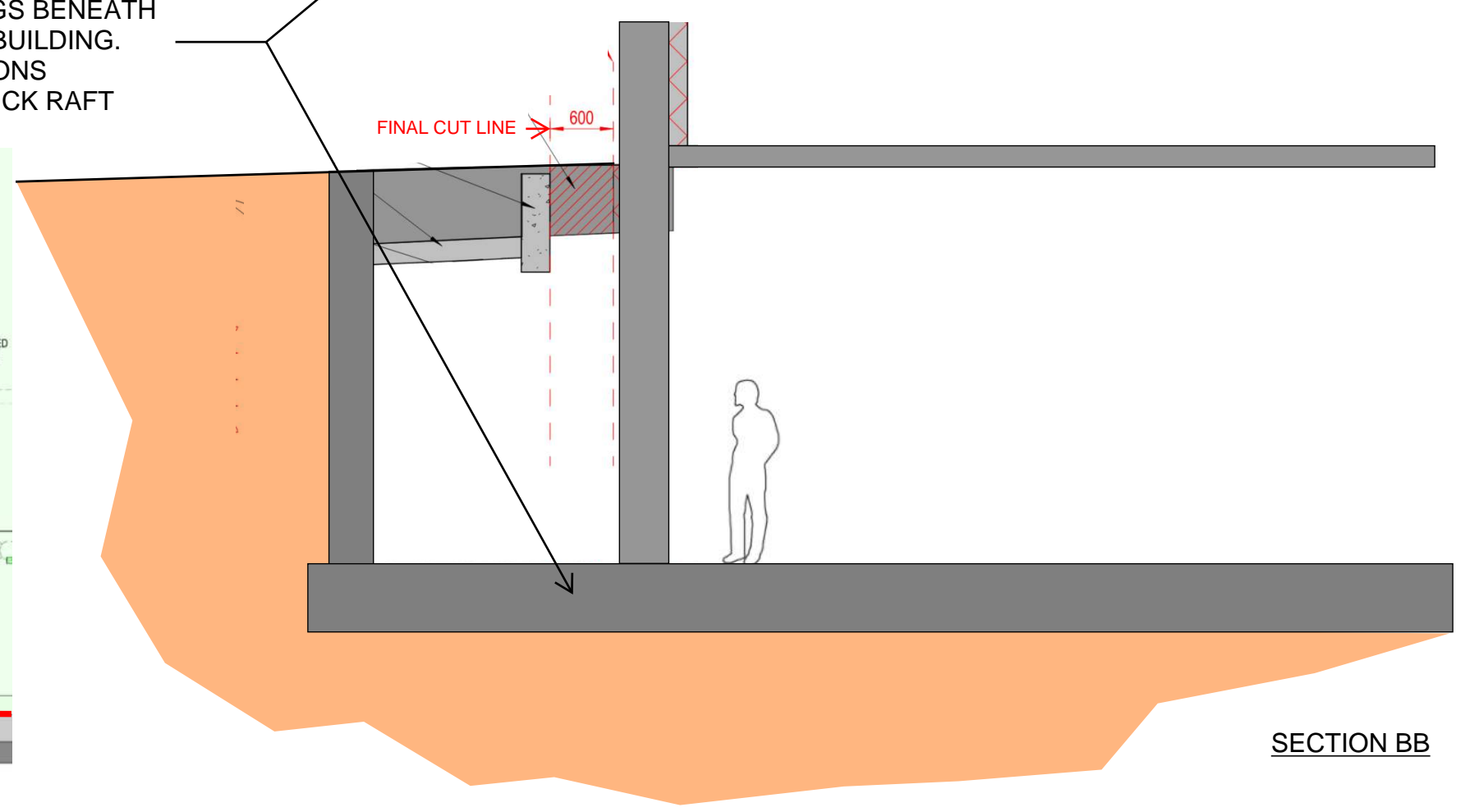
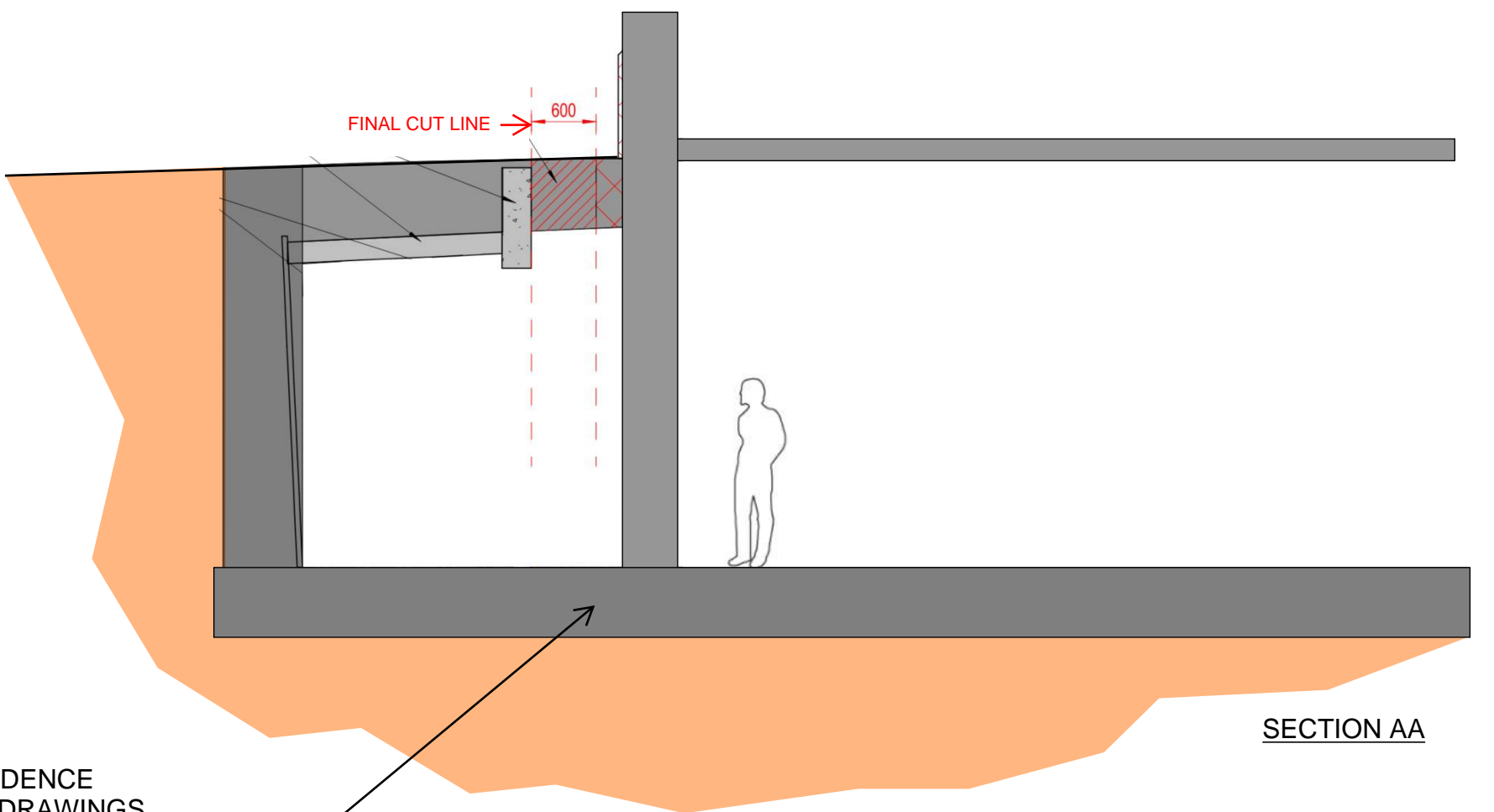

PROJECT TITLE	SKETCH TITLE	SKETCH No.	DRAWN	DATE
			SCALE	REV.



McGEE
A Specialist Engineering Contractor

McGee Group (Holdings) Ltd
Level 9 Alto Tower, 5 Hatfields
London SE1 9PG
Tel: 020 8998 1101 Fax: 020 8997 7690

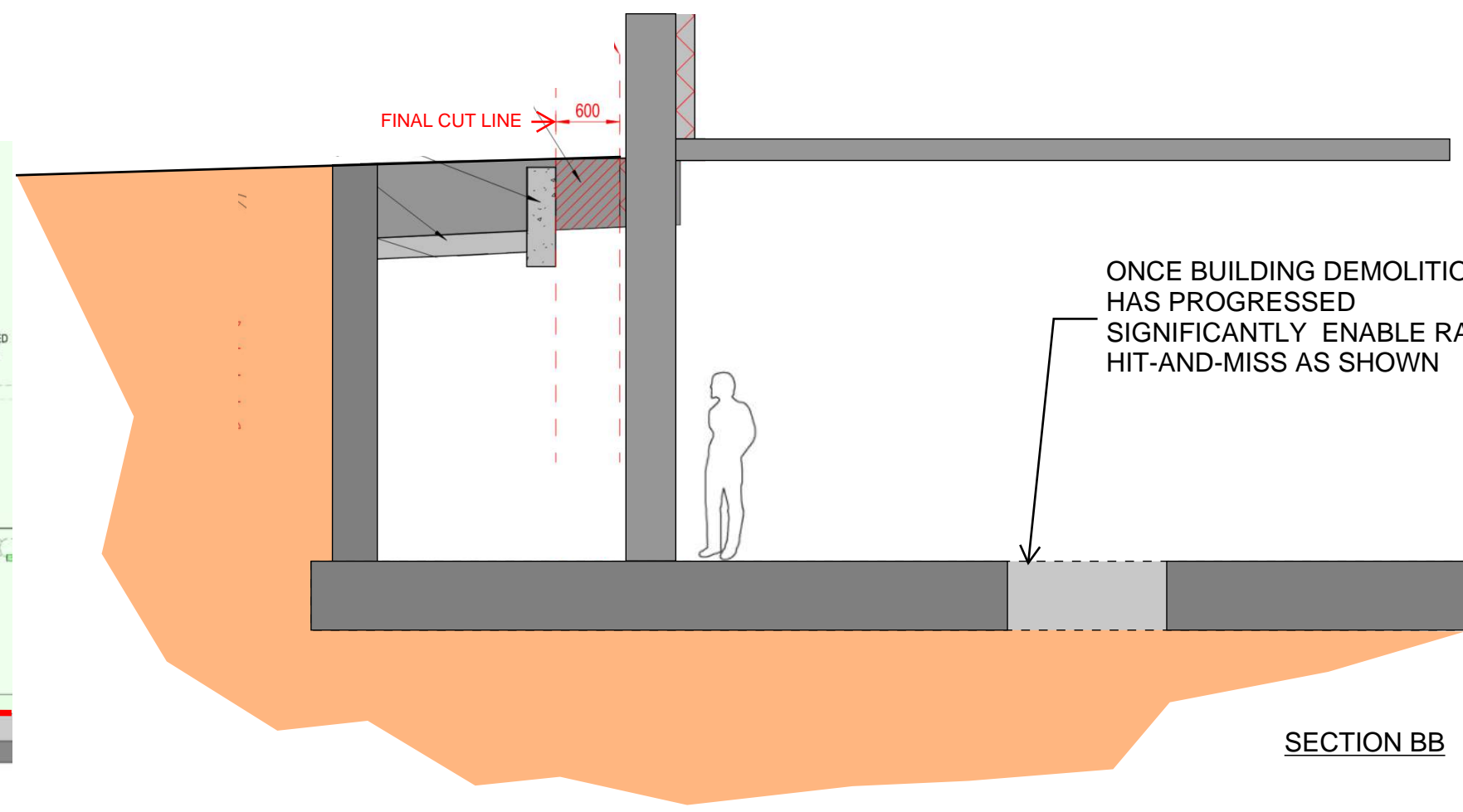
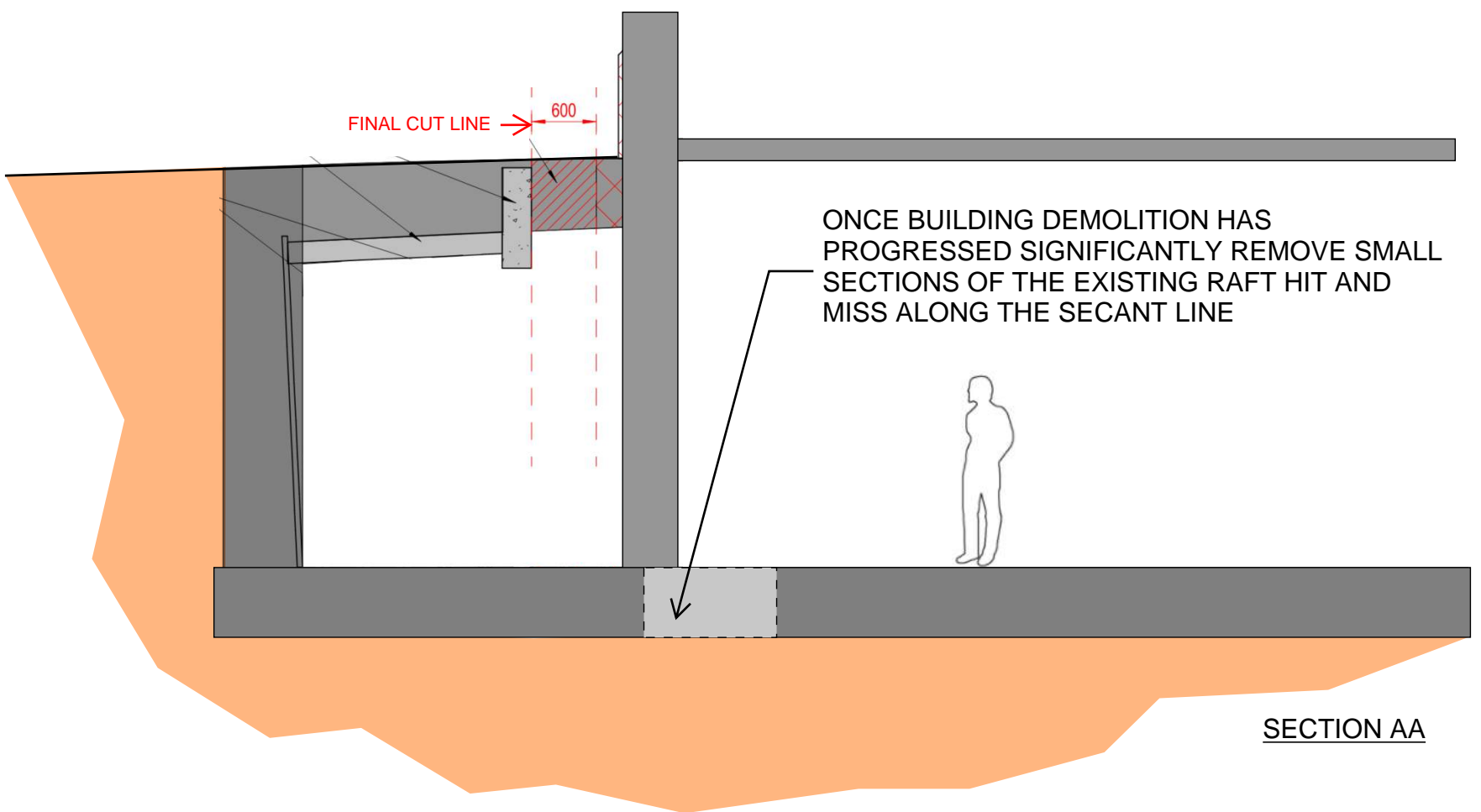
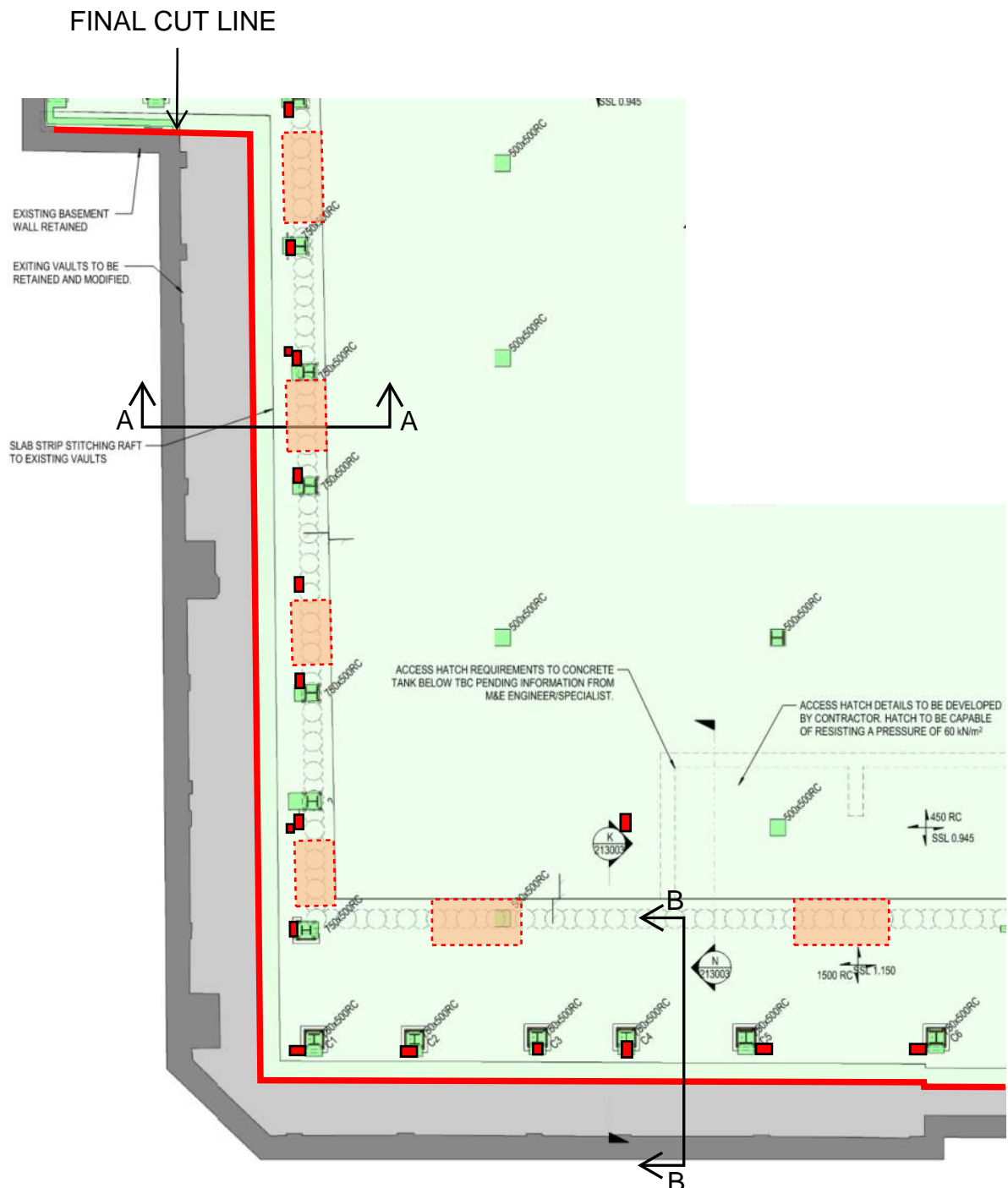

PROJECT TITLE	SKETCH TITLE	SKETCH No.	DRAWN	DATE
			SCALE	REV.



McGEE
A Specialist Engineering Contractor

McGee Group (Holdings) Ltd
Level 9 Alto Tower, 5 Hatfields
London SE1 9PG
Tel: 020 8998 1101 Fax: 020 8997 7690

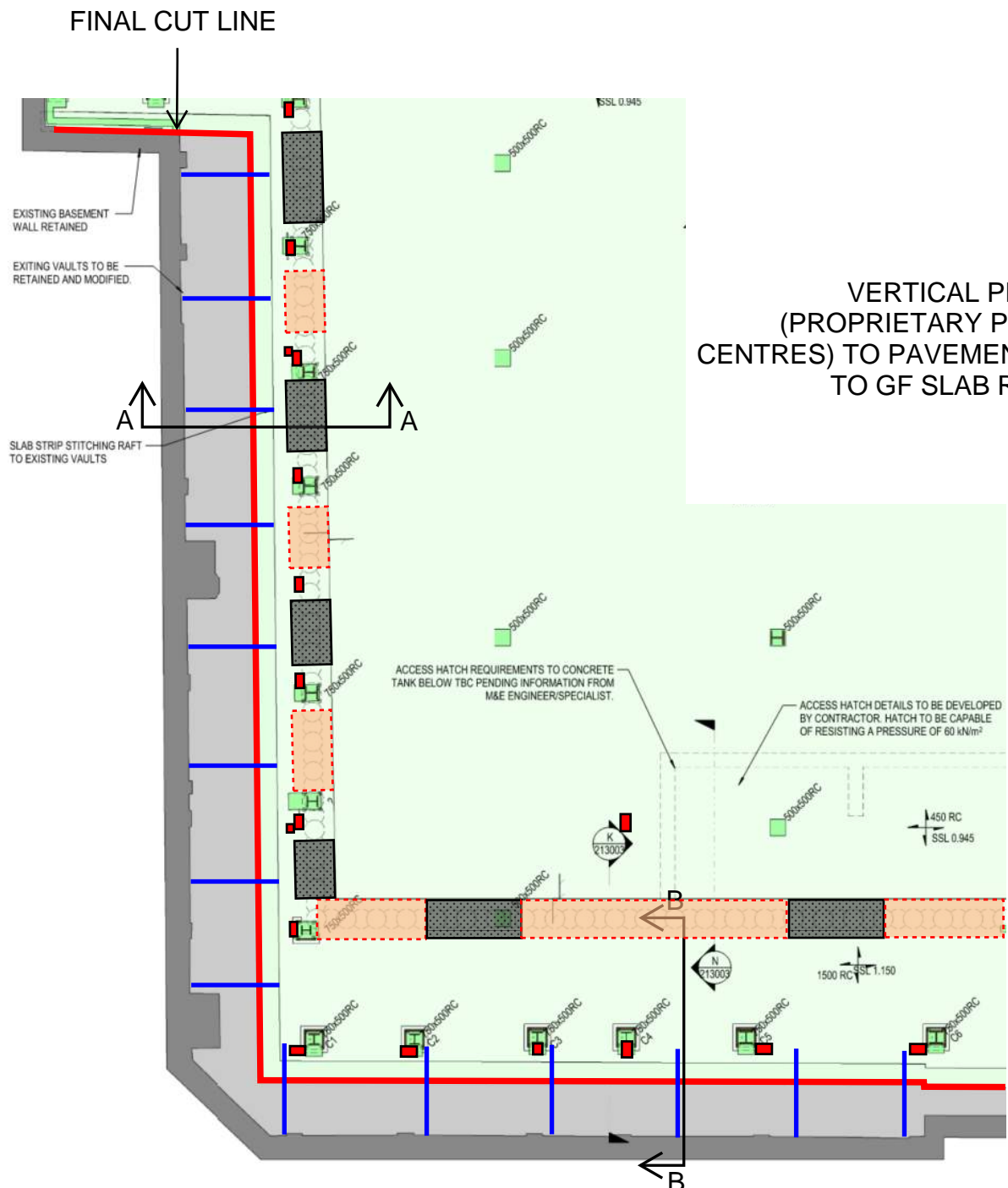

VERTICAL PROPPING
(PROPRIETARY PROPS 2m
CENTRES) TO PAVEMENT PRIOR
TO GF SLAB REMOVAL

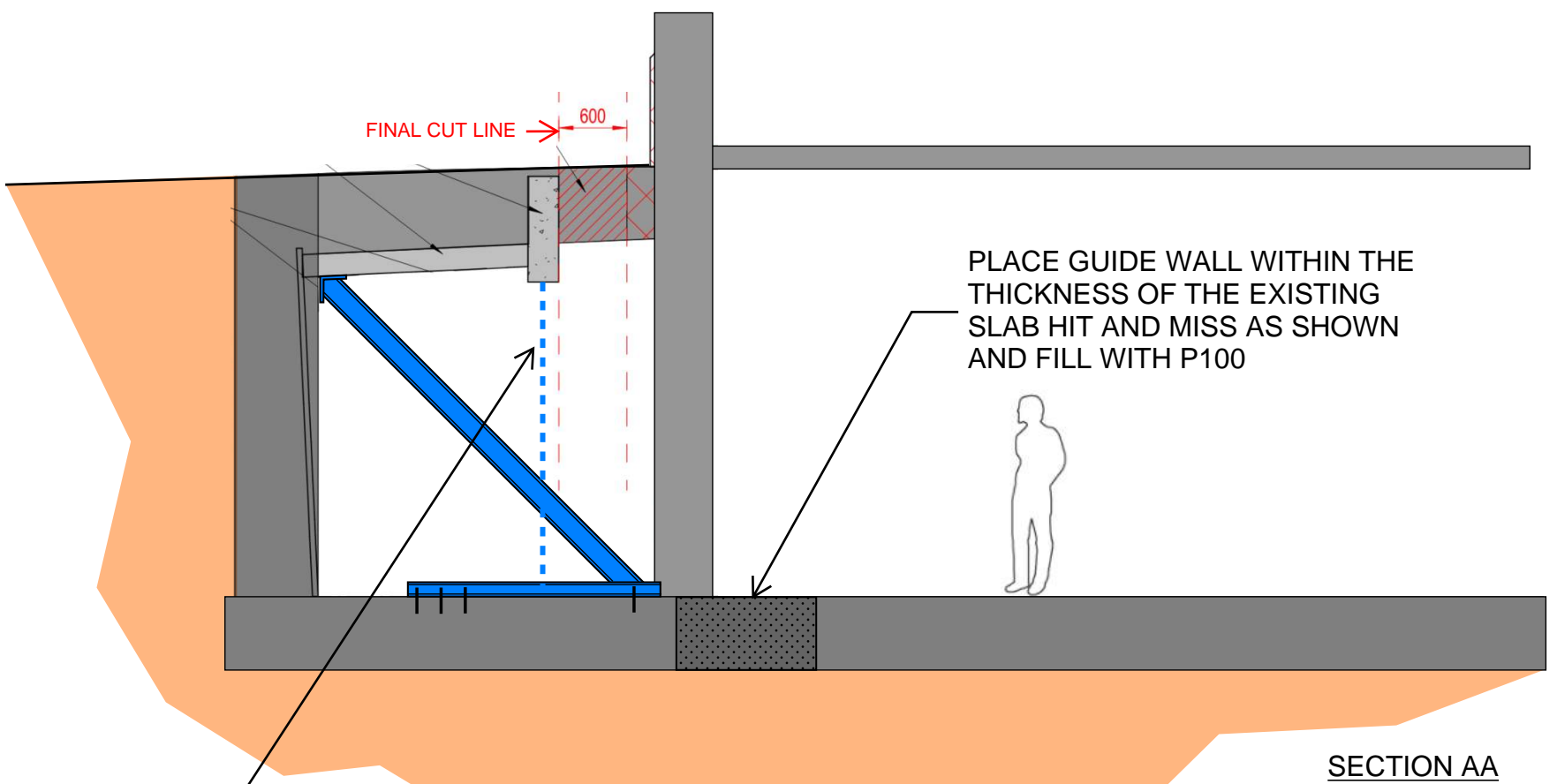

SECTION AA

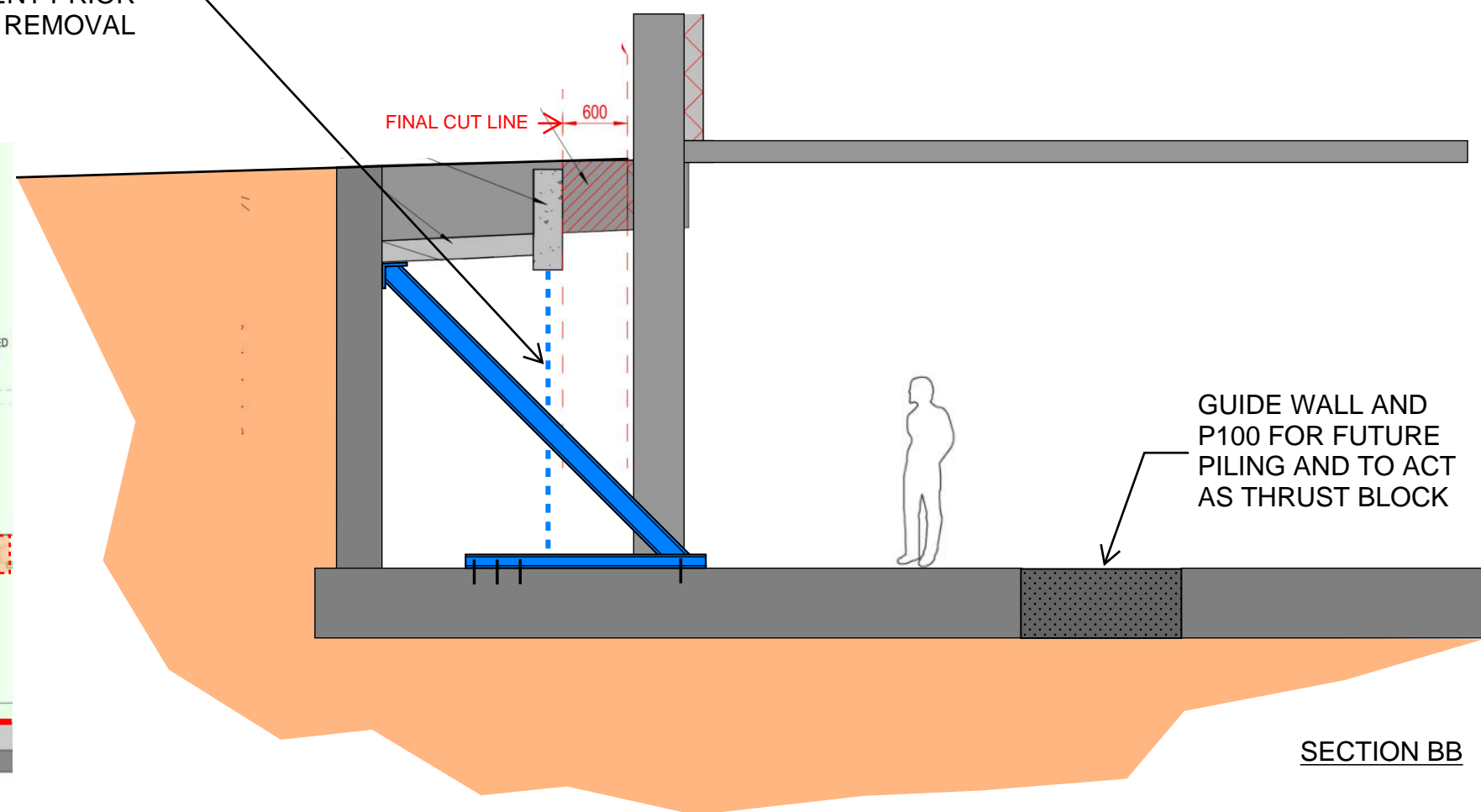

SECTION BB

PROJECT TITLE	SKETCH TITLE	SKETCH No.	DRAWN	DATE	 <p>McGEE A Specialist Engineering Contractor McGee Group (Holdings) Ltd Level 9 Alto Tower, 5 Hatfields London SE1 9PG Tel: 020 8998 1101 Fax: 020 8997 7690</p>
			SCALE	REV.	

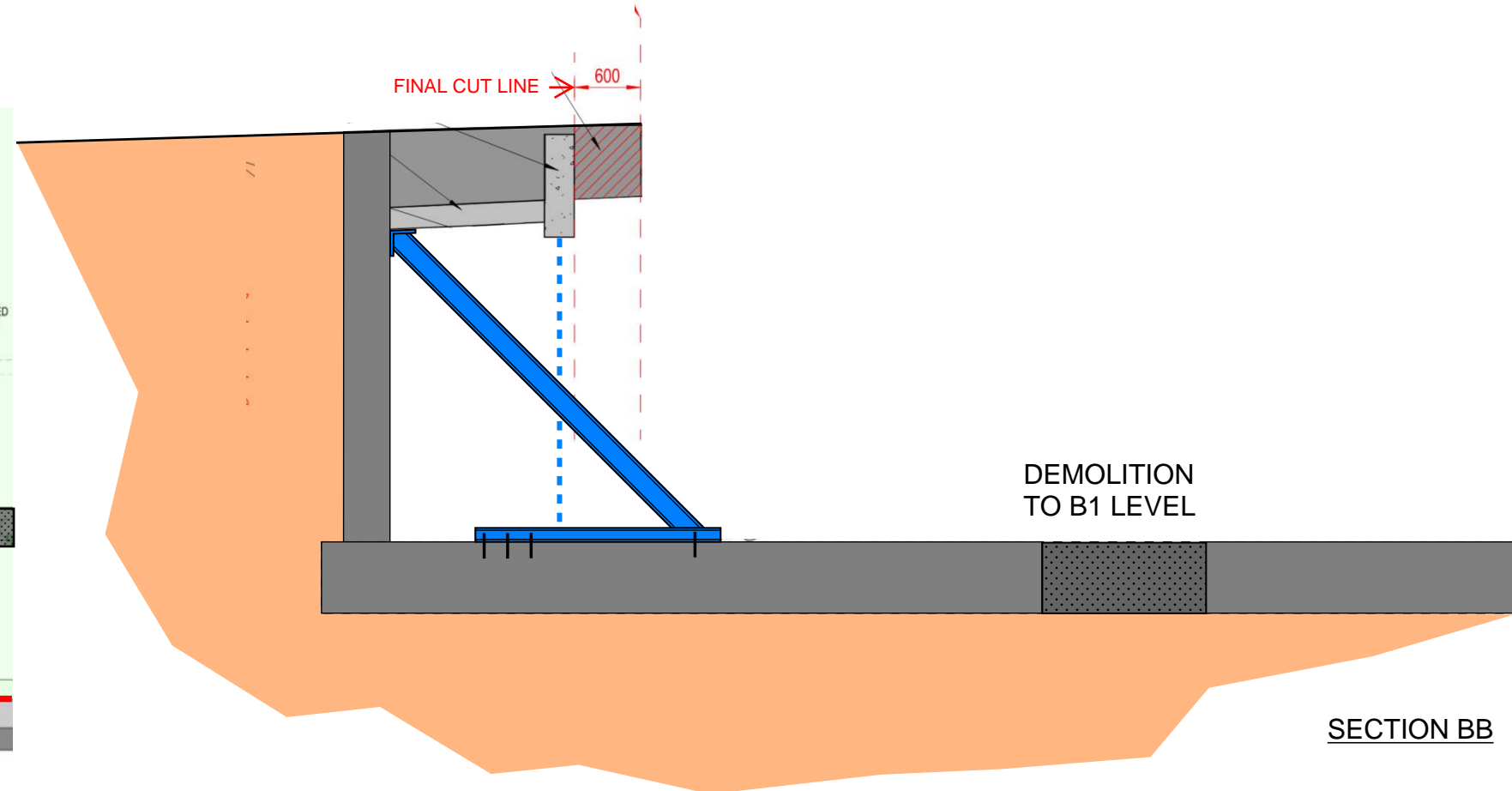
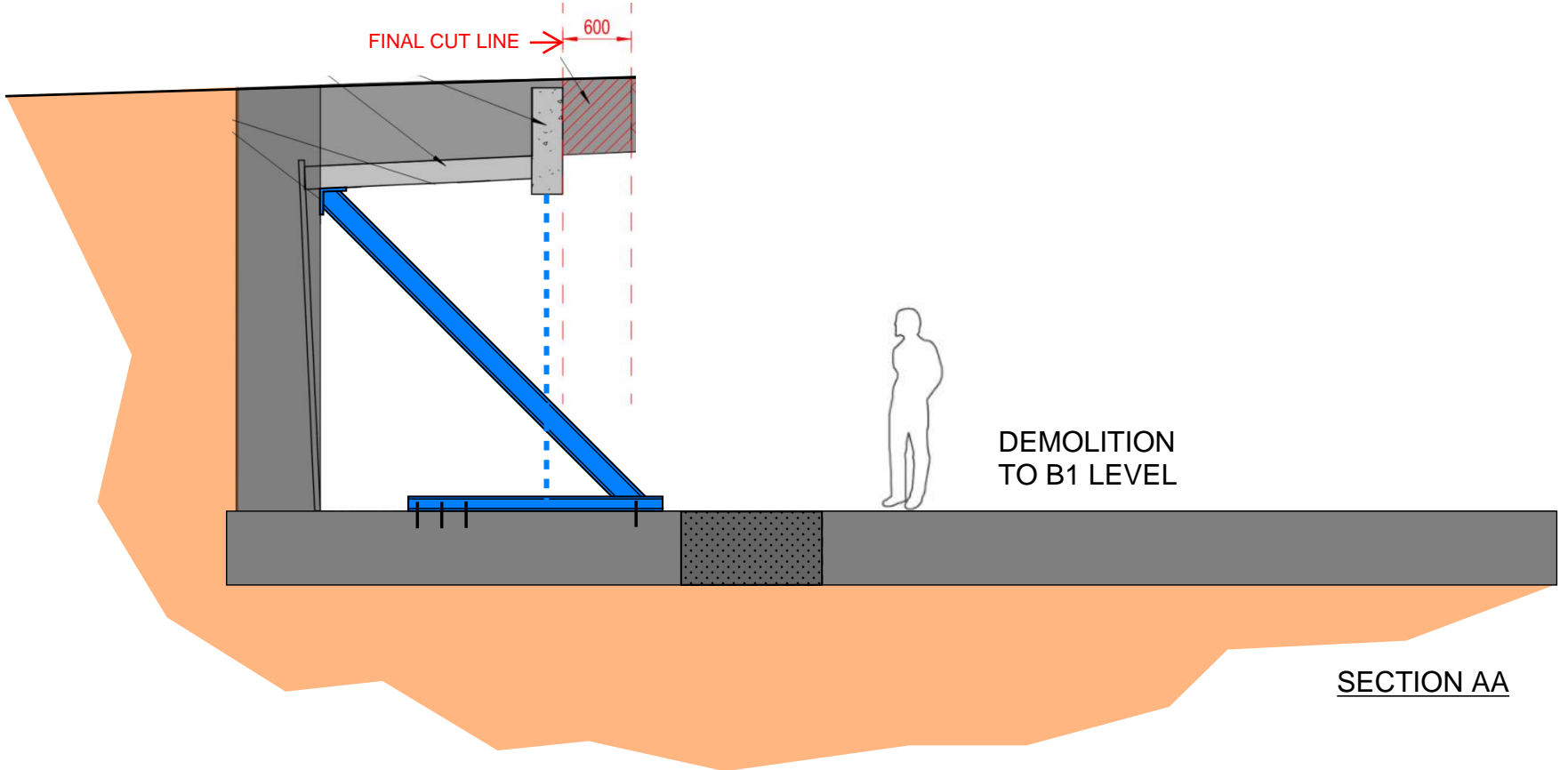
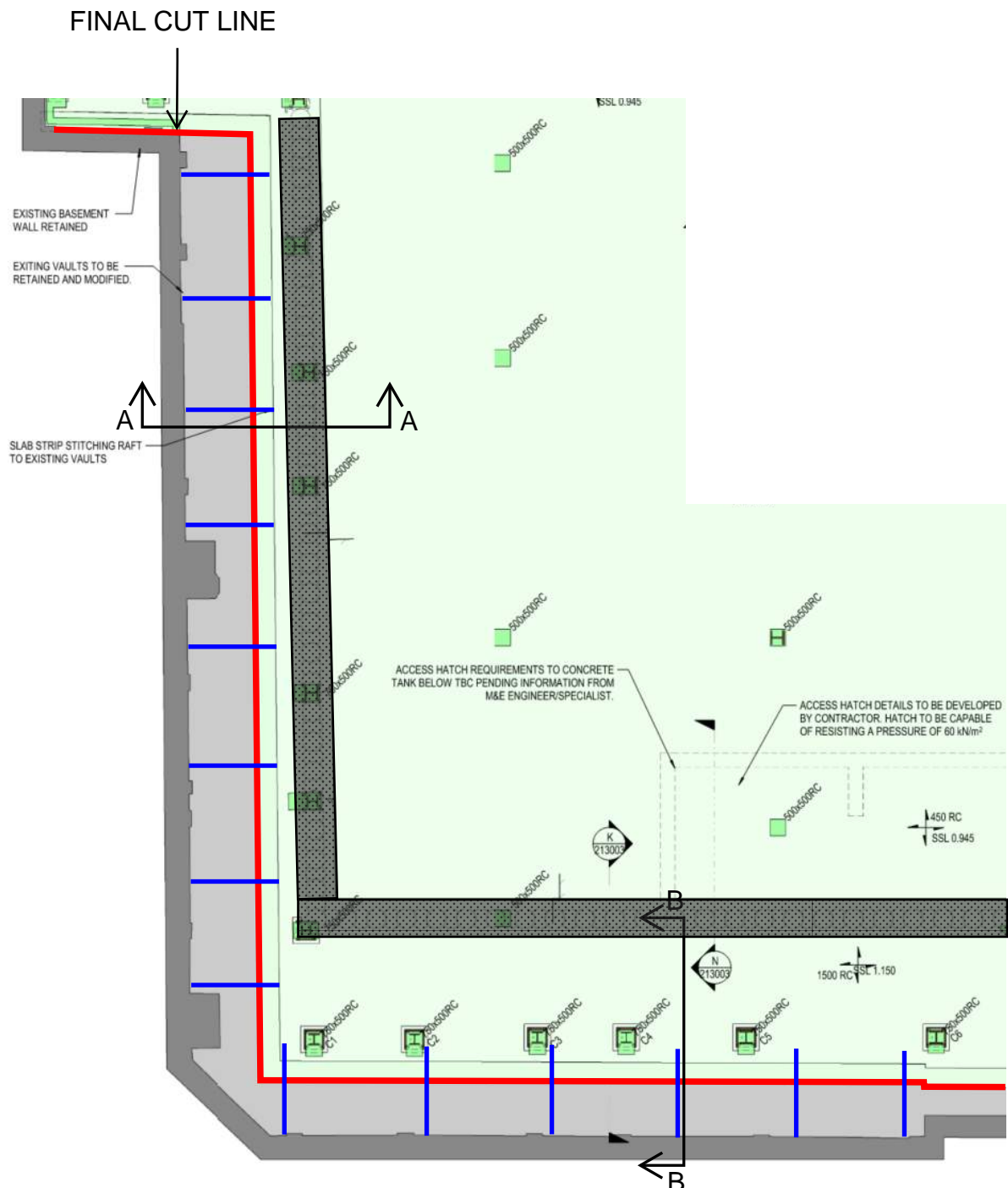

PROJECT TITLE	SKETCH TITLE
---------------	--------------

SKETCH No.	DRAWN	DATE
------------	-------	------

SCALE	REV.
-------	------

 <p>McGEE A Specialist Engineering Contractor</p>	
<p>McGee Group (Holdings) Ltd Level 9 Alto Tower, 5 Hatfields London SE1 9PG Tel: 020 8998 1101 Fax: 020 8997 7690</p>	

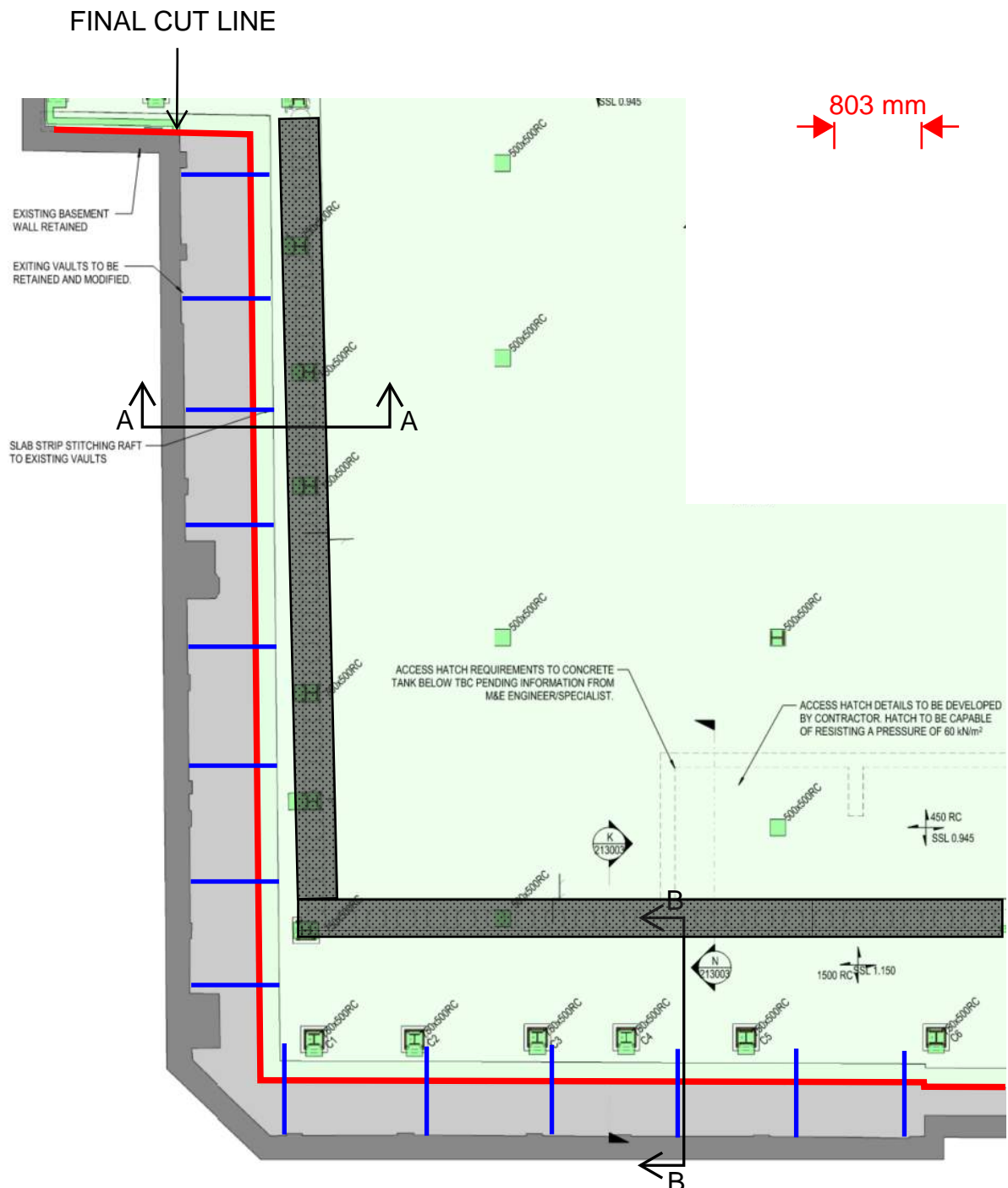

803 mm

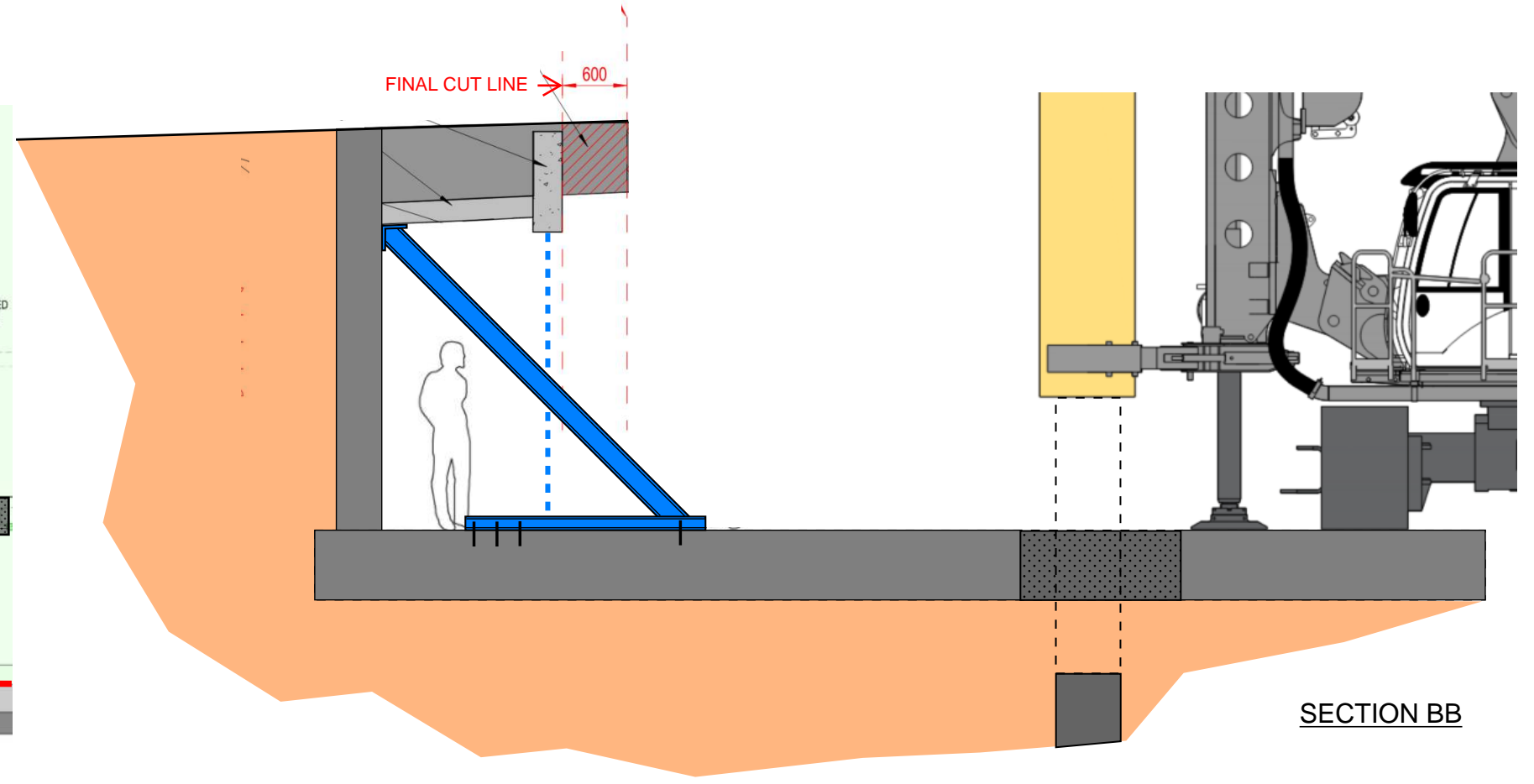
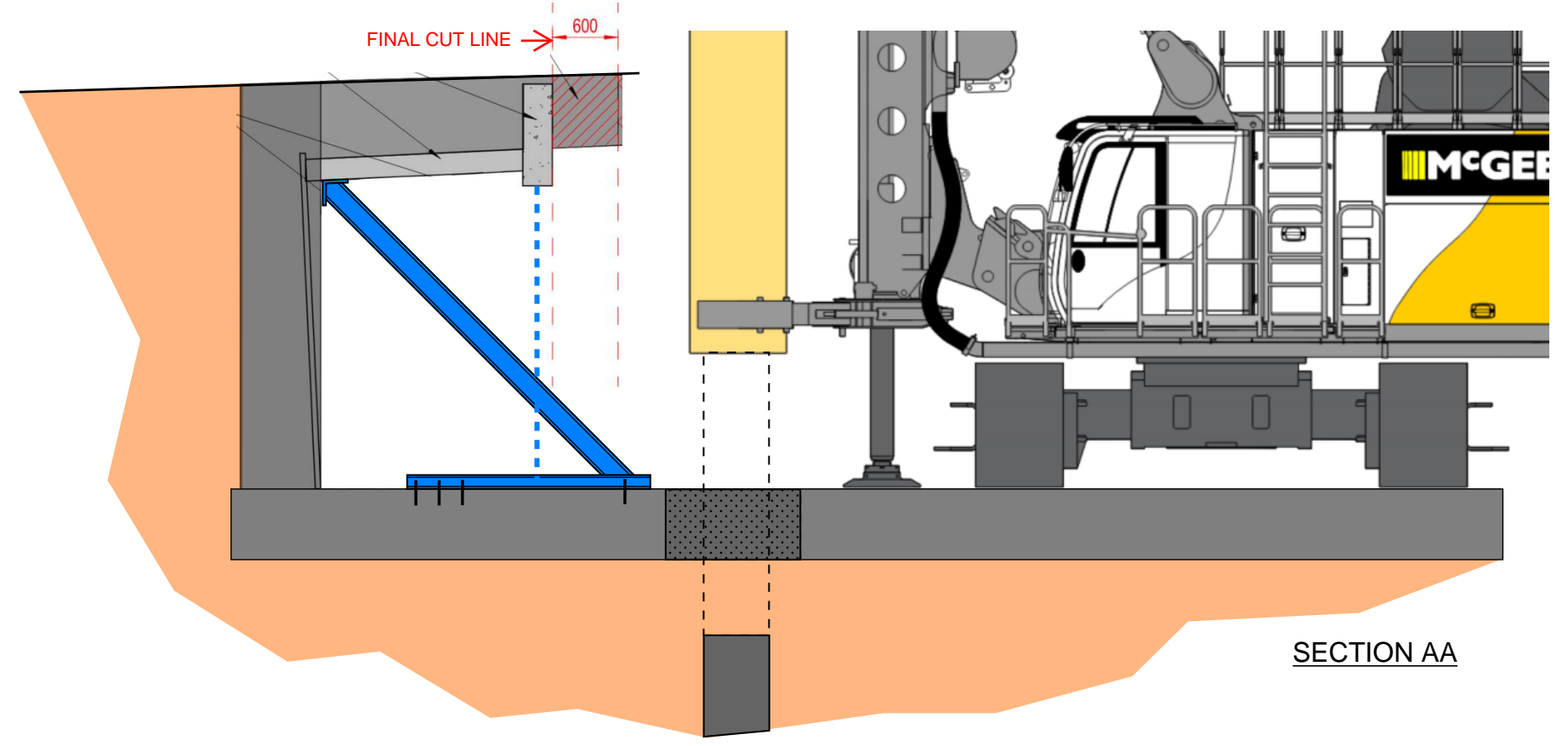

PROJECT TITLE	SKETCH TITLE	SKETCH No.	DRAWN	DATE	 <p>McGEE A Specialist Engineering Contractor McGee Group (Holdings) Ltd Level 9 Alto Tower, 5 Hatfields London SE1 9PG Tel: 020 8998 1101 Fax: 020 8997 7690</p>
			SCALE	REV.	

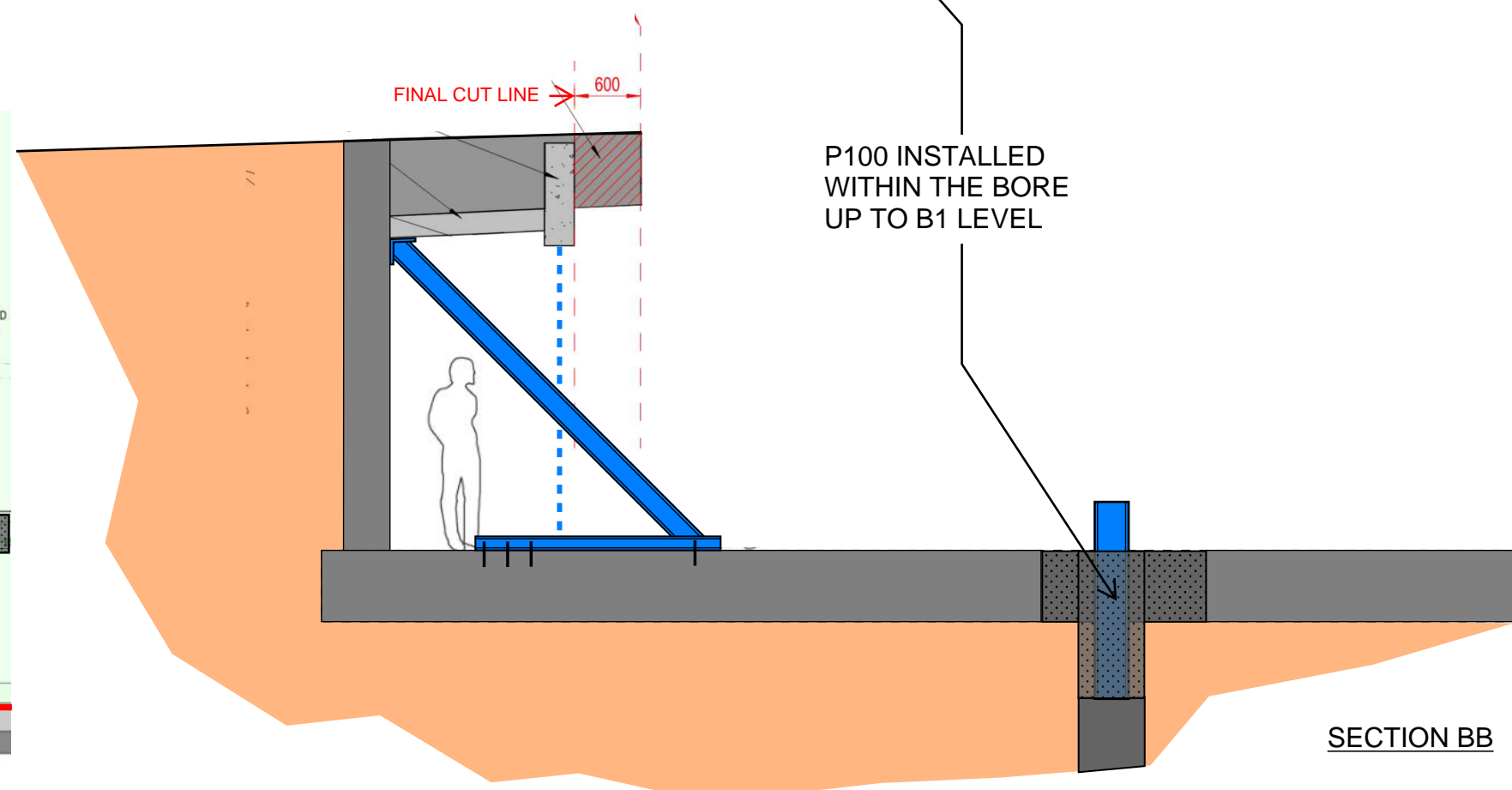
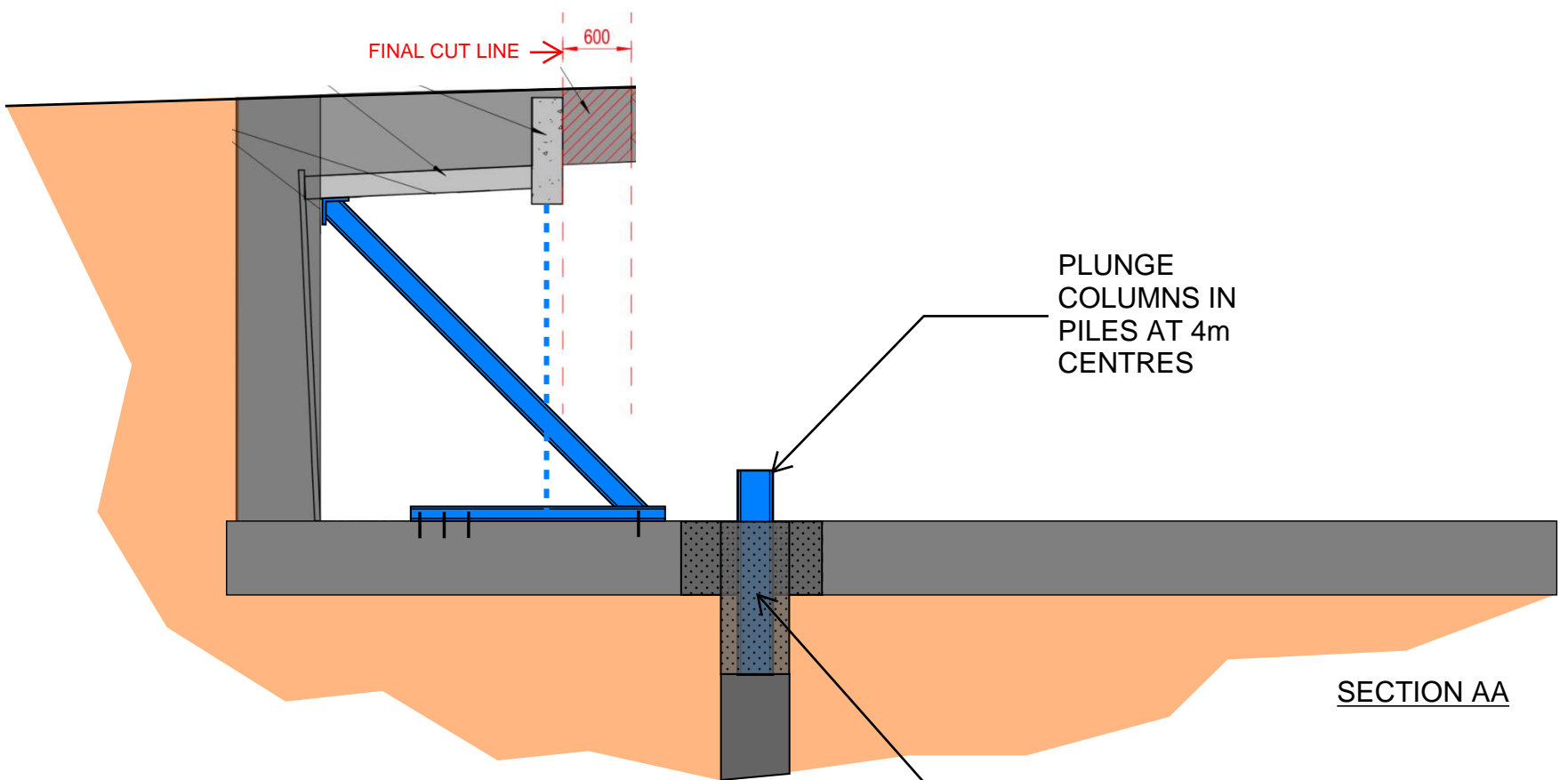
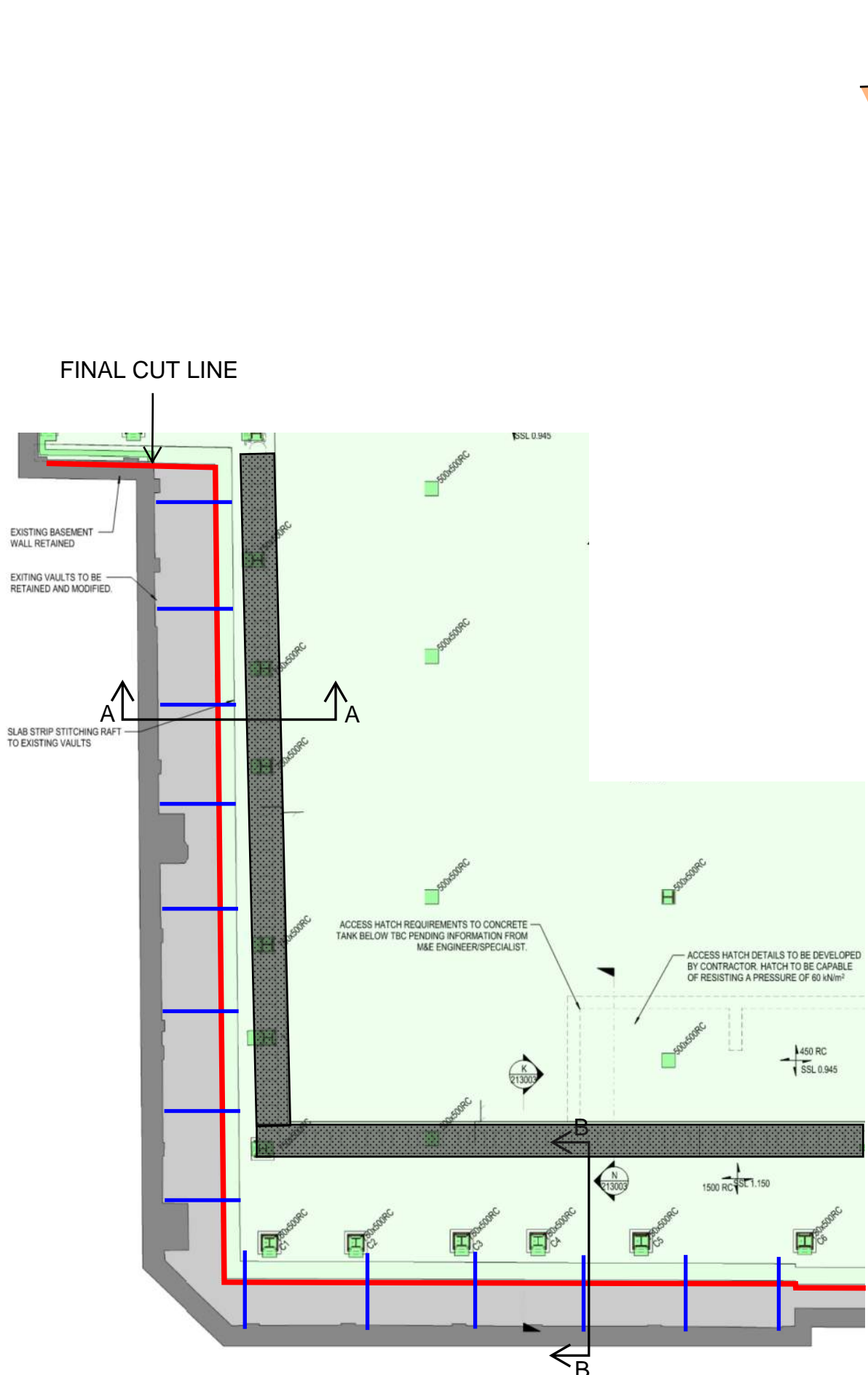

PROJECT TITLE	SKETCH TITLE	SKETCH No.	DRAWN	DATE
			SCALE	REV.



McGEE
A Specialist Engineering Contractor

McGee Group (Holdings) Ltd
Level 9 Alto Tower, 5 Hatfields
London SE1 9PG
Tel: 020 8998 1101 Fax: 020 8997 7690

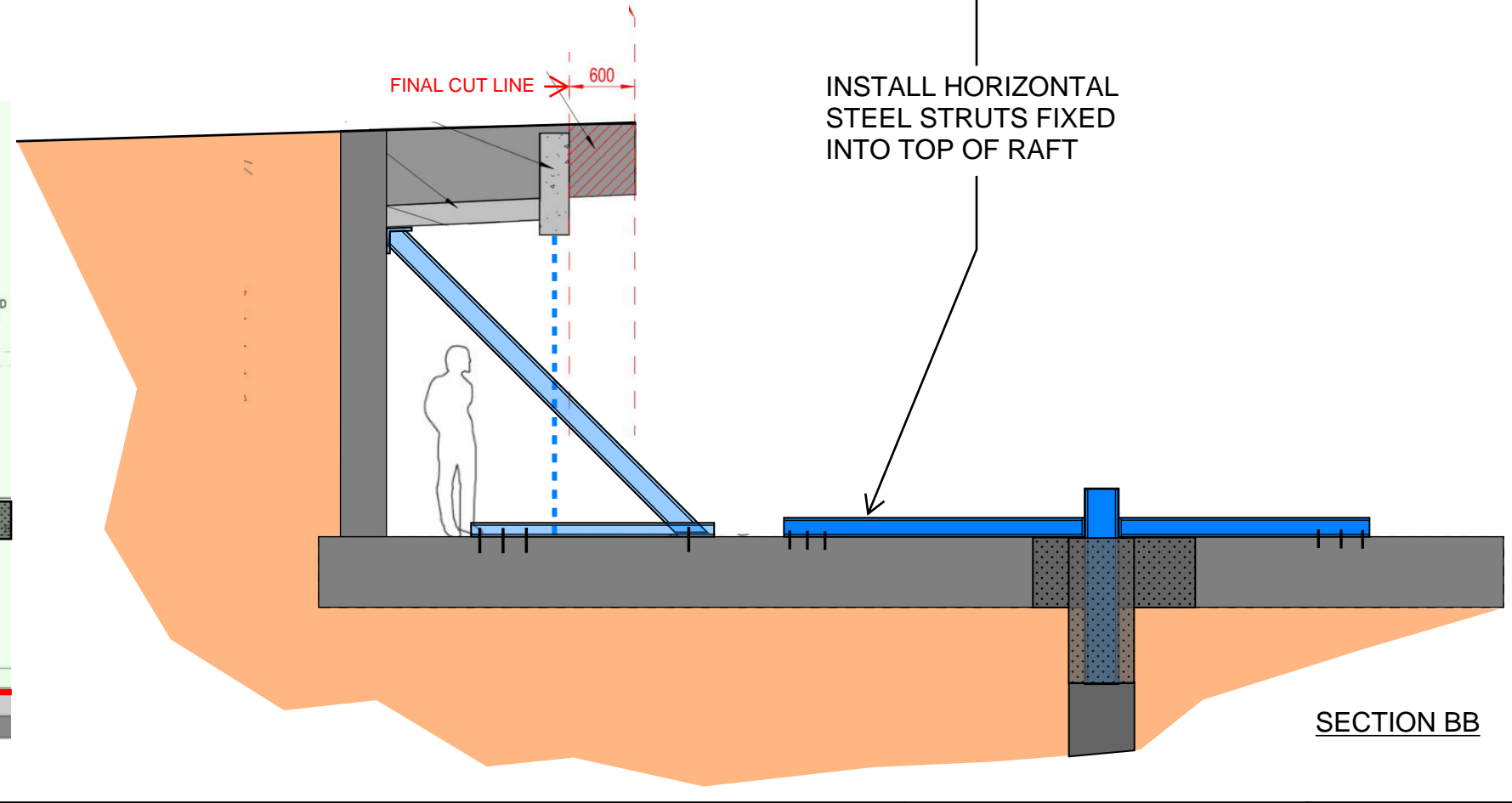
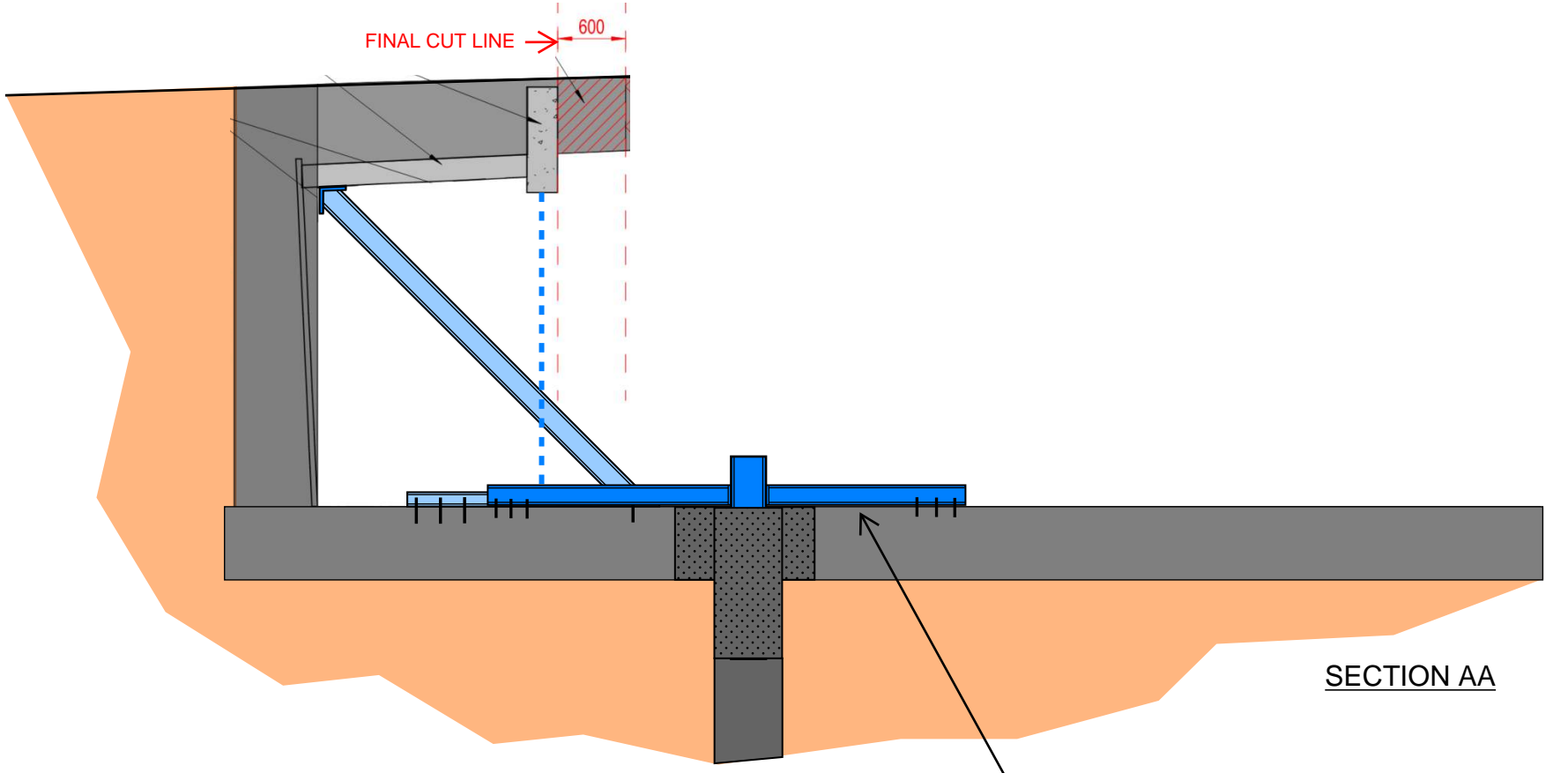
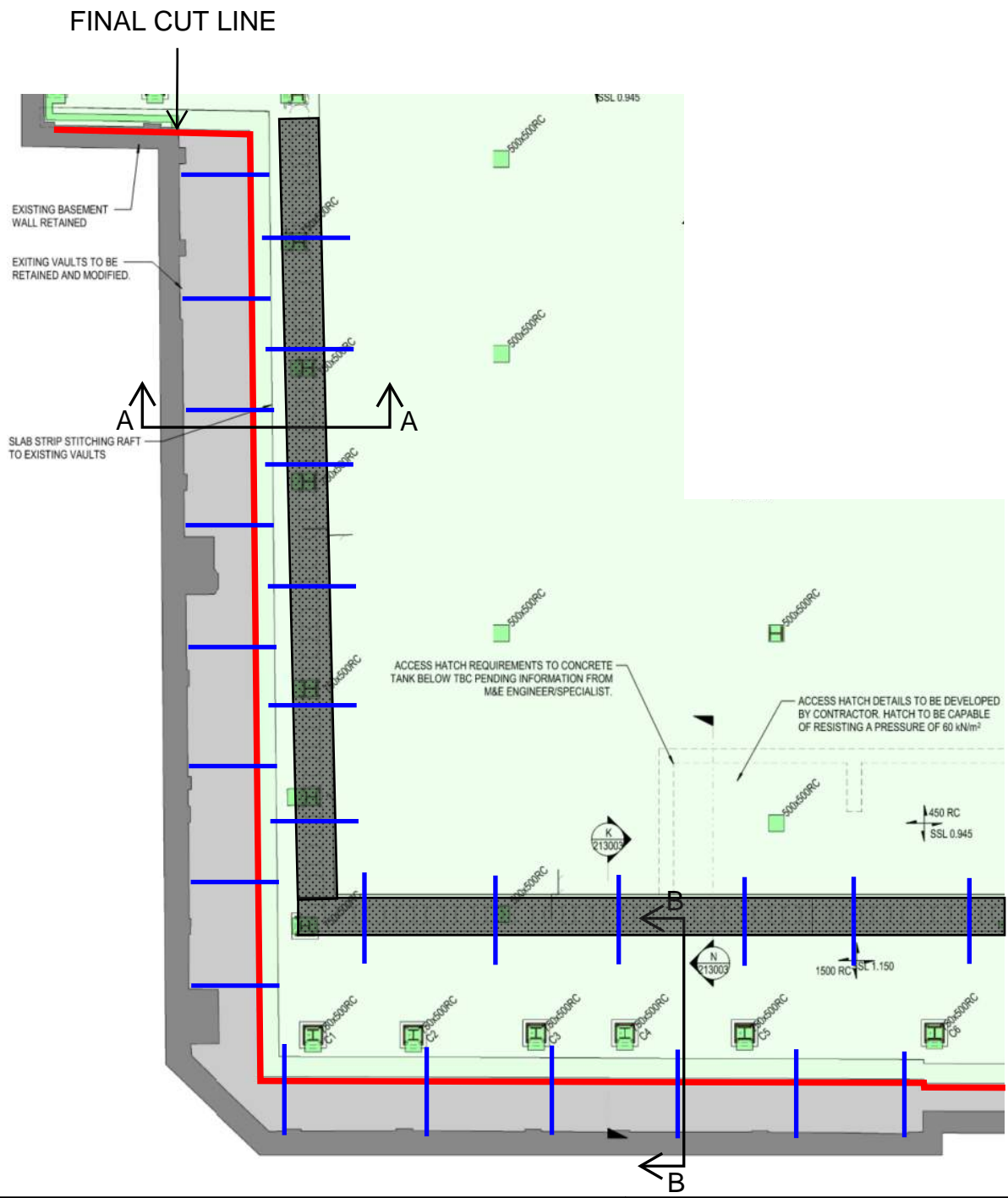

PROJECT TITLE	SKETCH TITLE

SKETCH No.	DRAWN	DATE

SCALE	REV.

McGEE
A Specialist Engineering Contractor

McGee Group (Holdings) Ltd
Level 9 Alto Tower, 5 Hatfields
London SE1 9PG
Tel: 020 8998 1101 Fax: 020 8997 7690

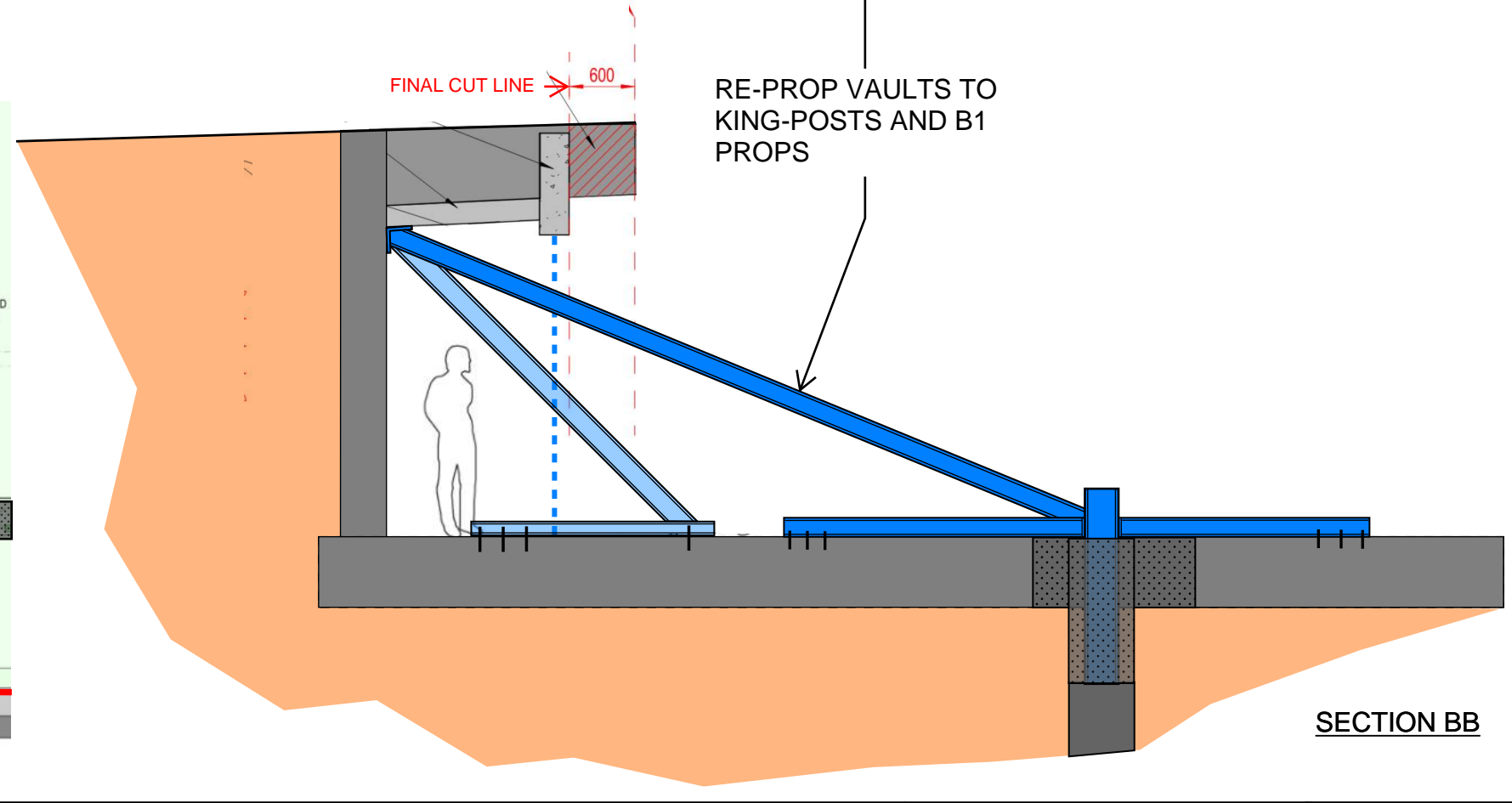
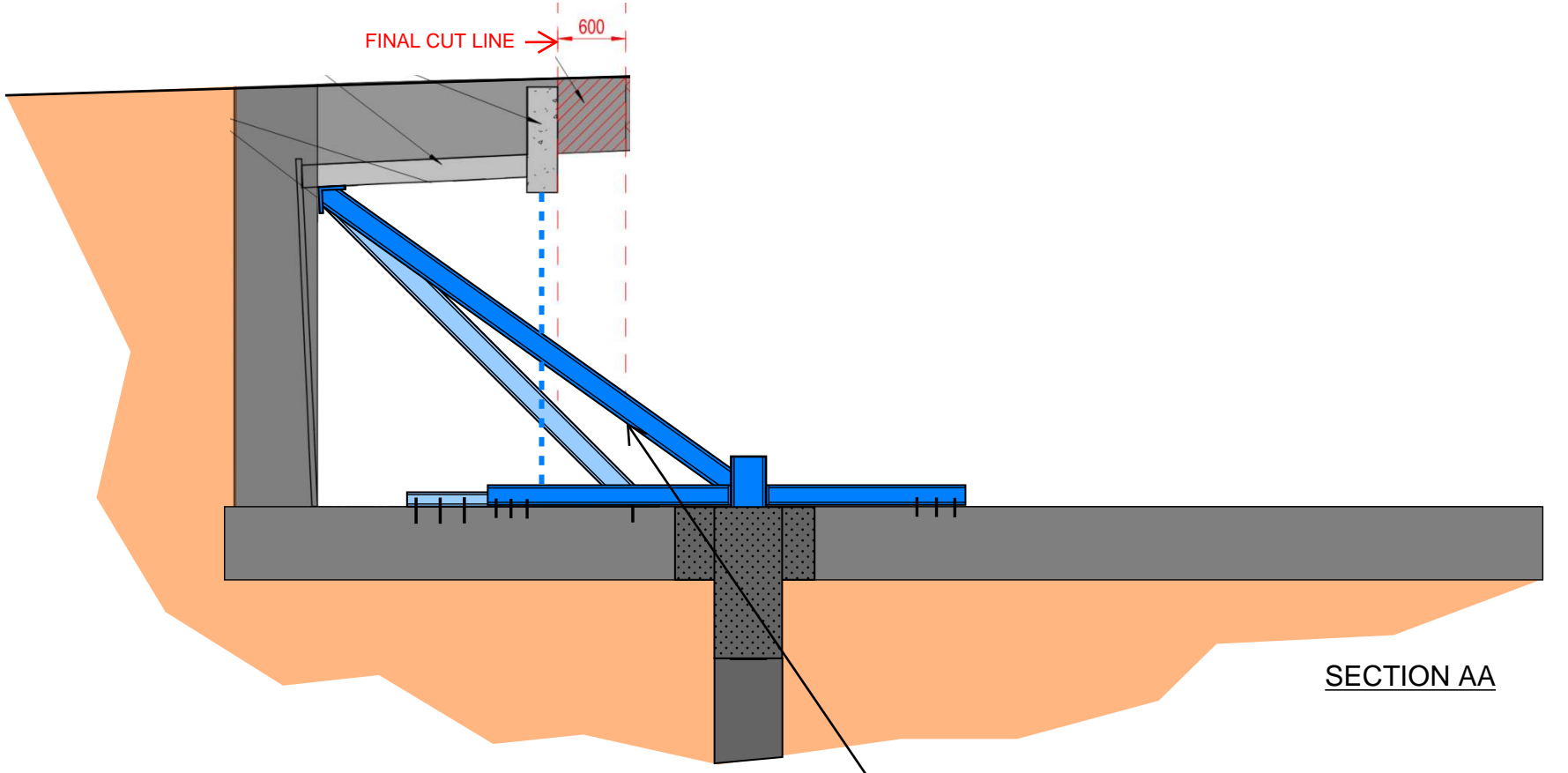
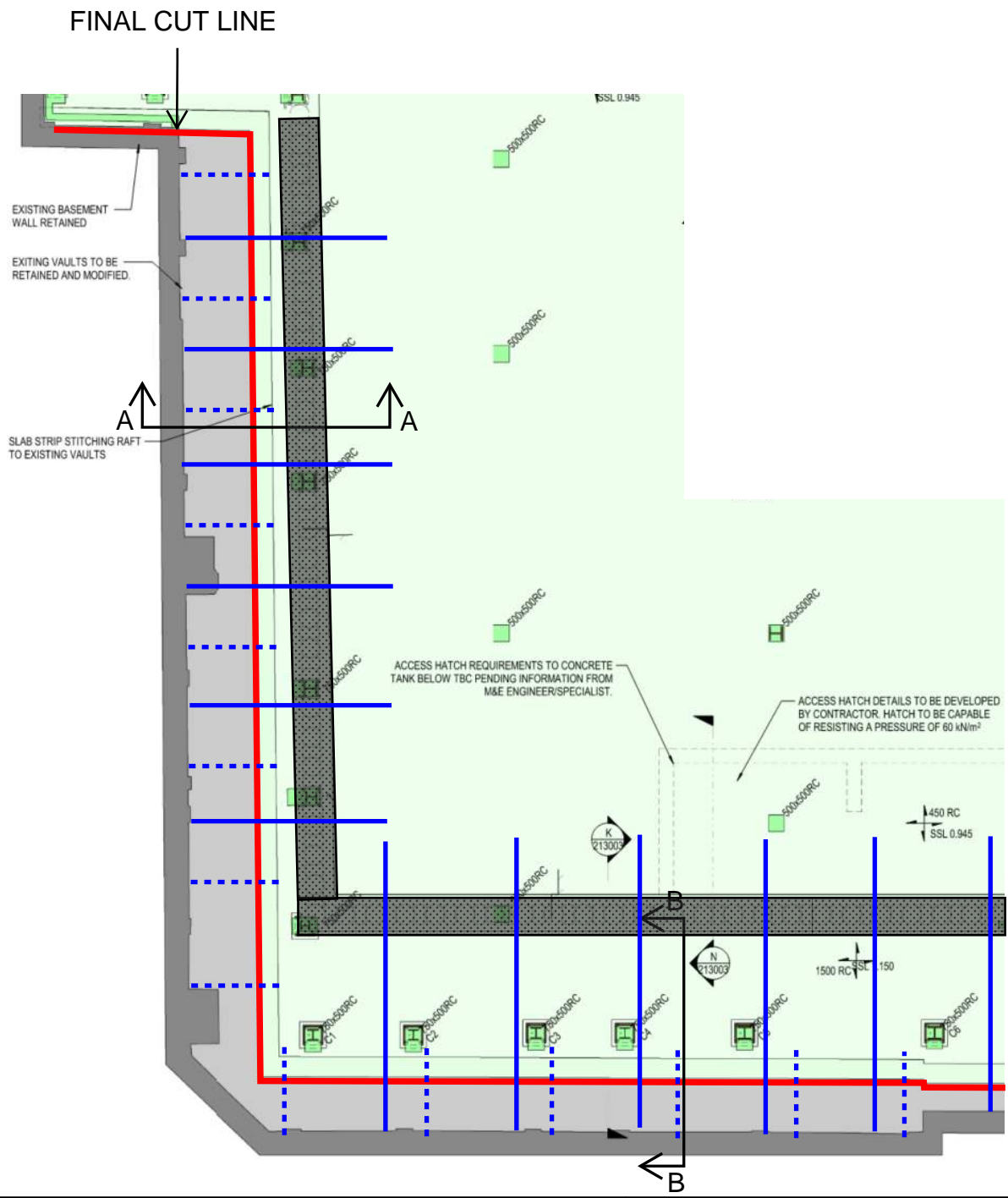

PROJECT TITLE	SKETCH TITLE
---------------	--------------

SKETCH No.

DRAWN	DATE
SCALE	REV.

DRAWN	DATE
SCALE	REV.

McGEE
A Specialist Engineering Contractor

McGee Group (Holdings) Ltd
Level 9 Alto Tower, 5 Hatfields
London SE1 9PG
Tel: 020 8998 1101 Fax: 020 8997 7690

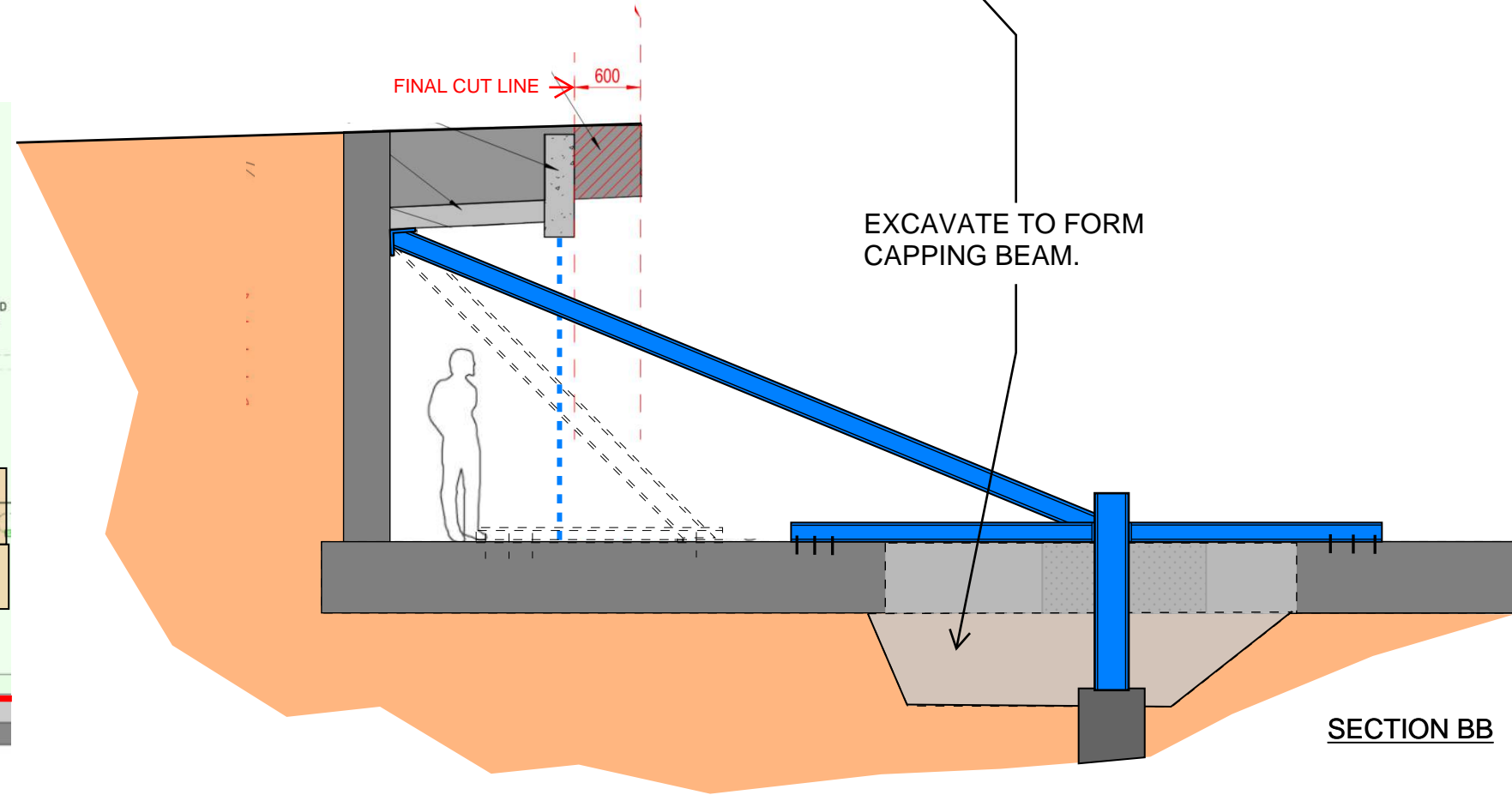
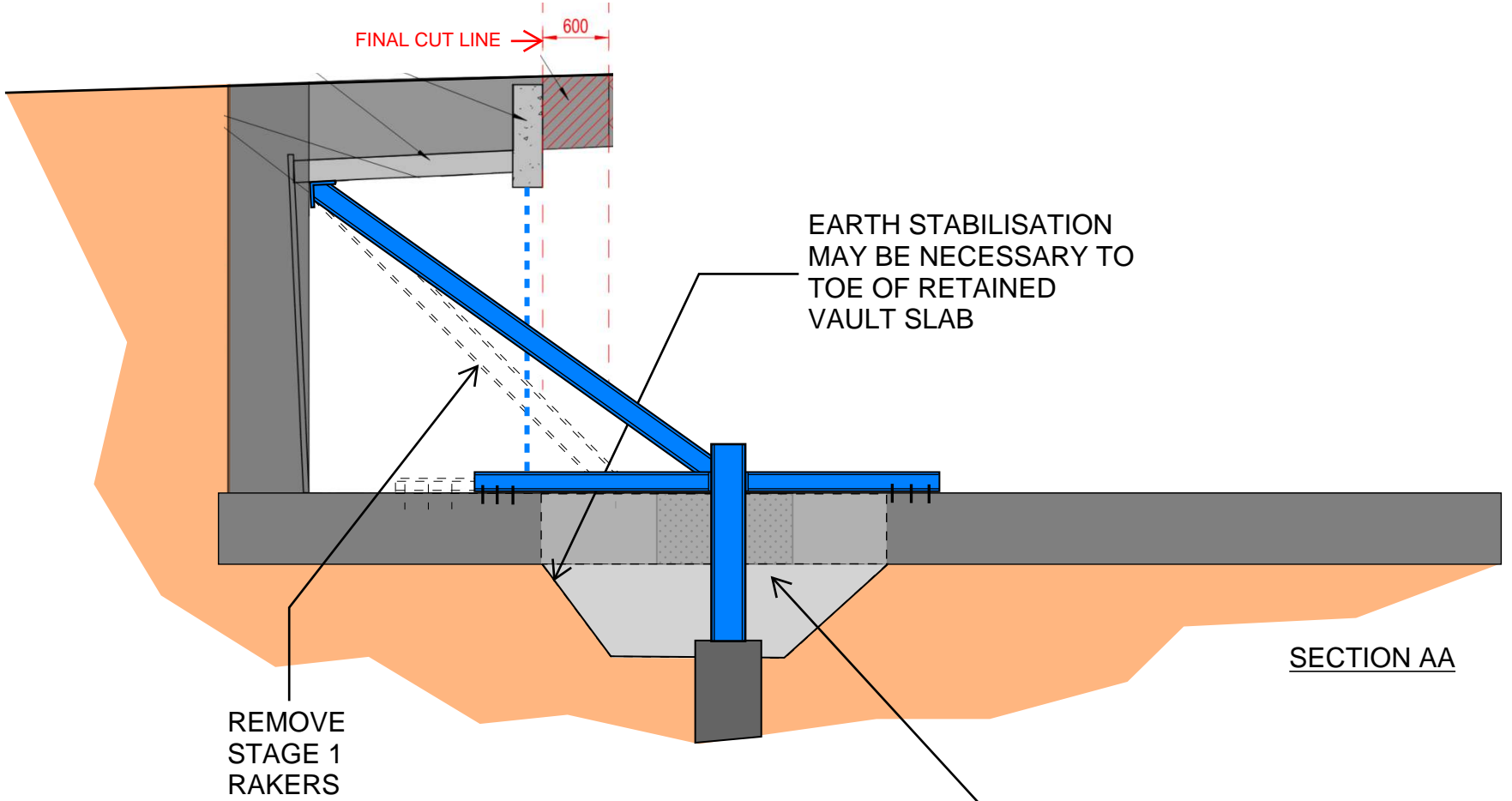
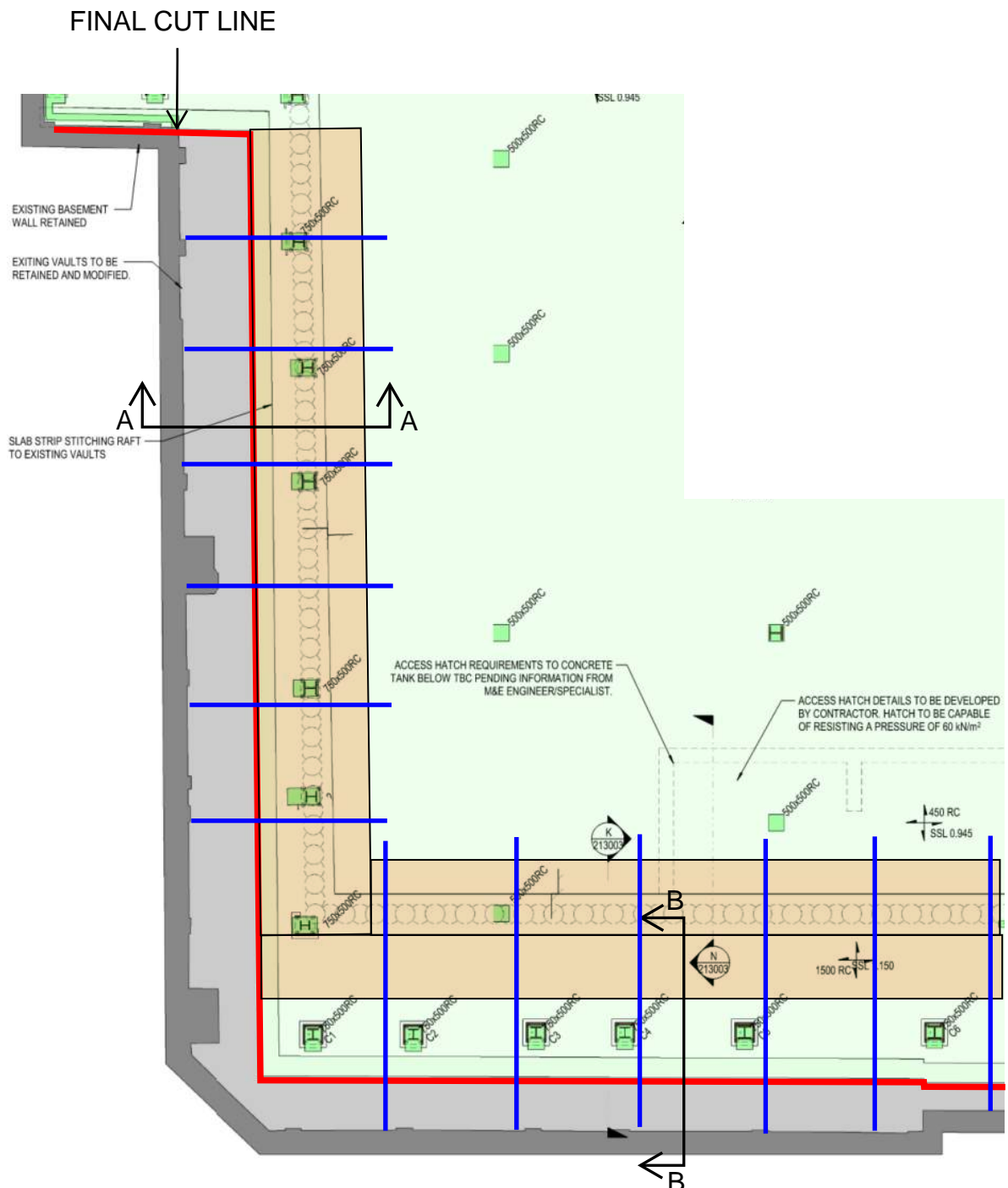

PROJECT TITLE	SKETCH TITLE	SKETCH No.	DRAWN	DATE
			SCALE	REV.



McGEE
A Specialist Engineering Contractor

McGee Group (Holdings) Ltd
Level 9 Alto Tower, 5 Hatfields
London SE1 9PG
Tel: 020 8998 1101 Fax: 020 8997 7690

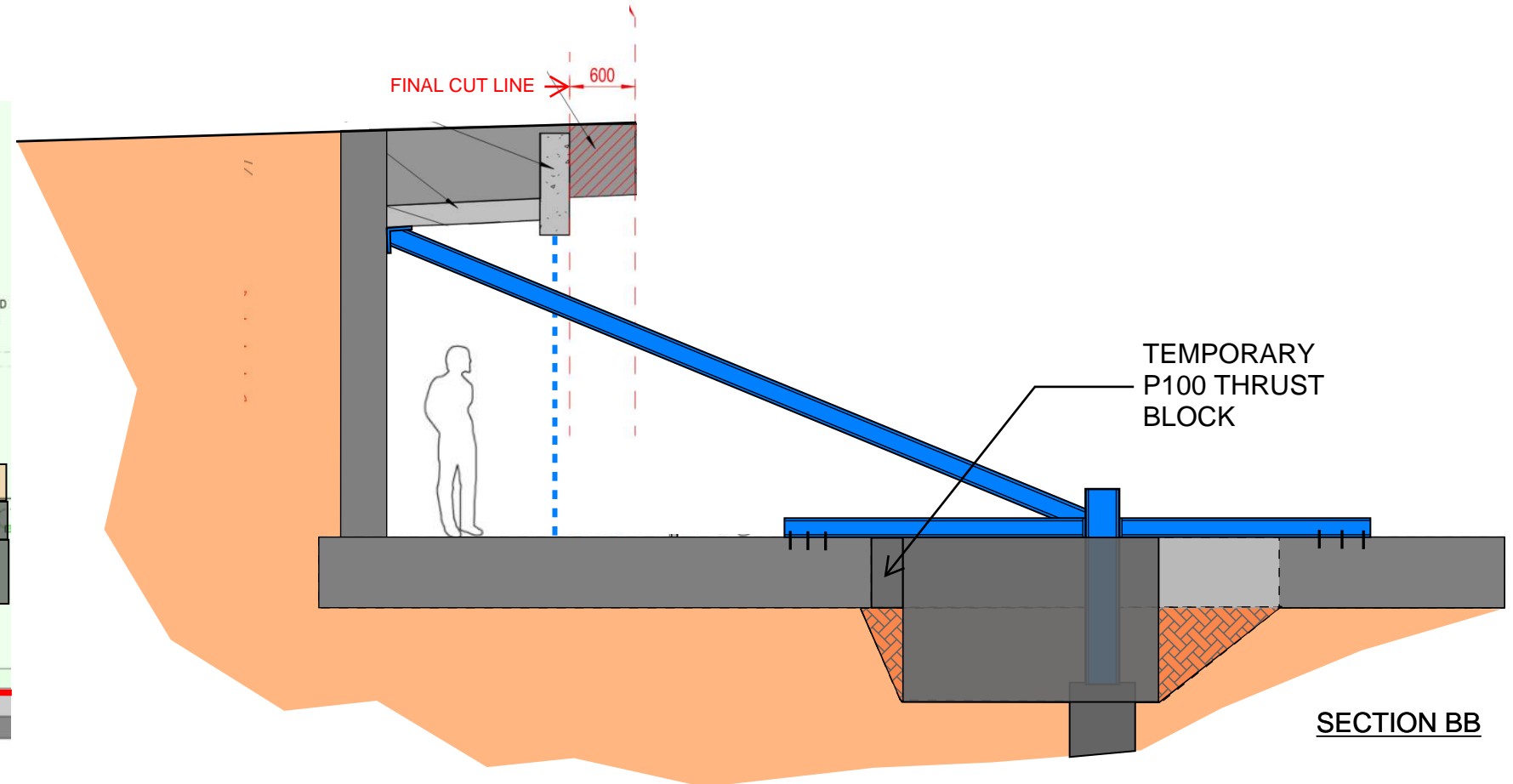
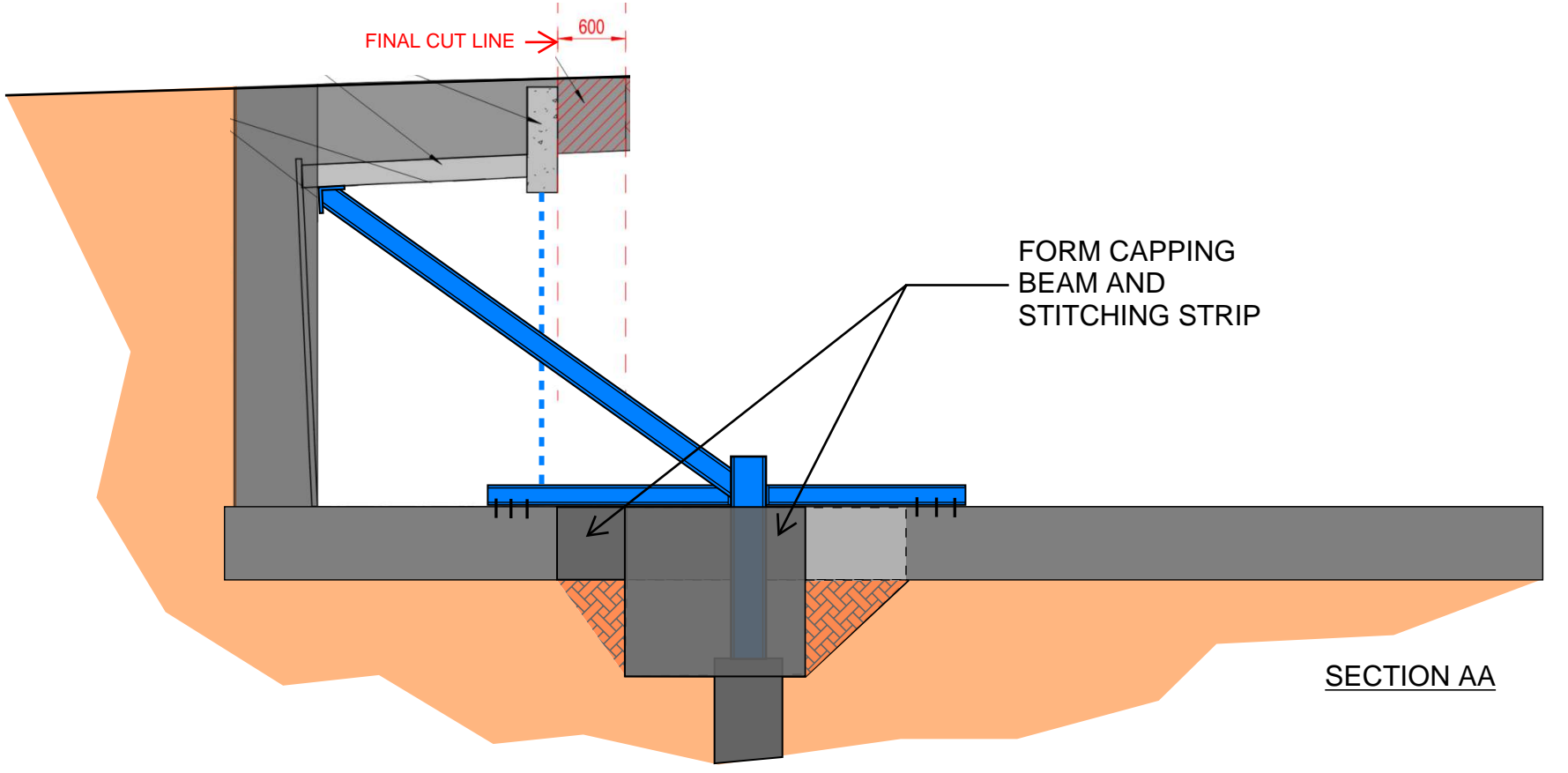
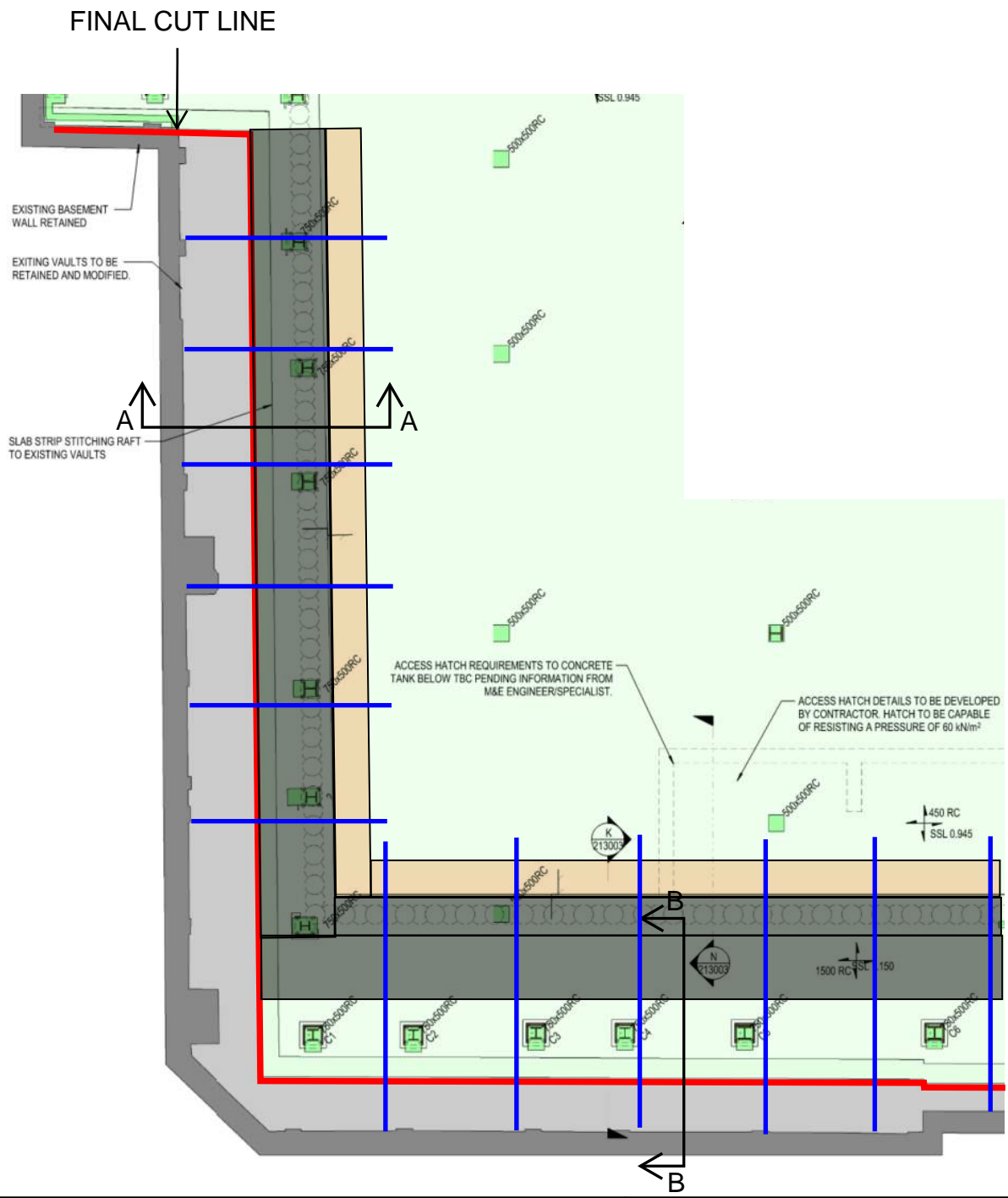



PROJECT TITLE	SKETCH TITLE
---------------	--------------

SKETCH No.	DRAWN	DATE
------------	-------	------

SCALE	REV.
-------	------

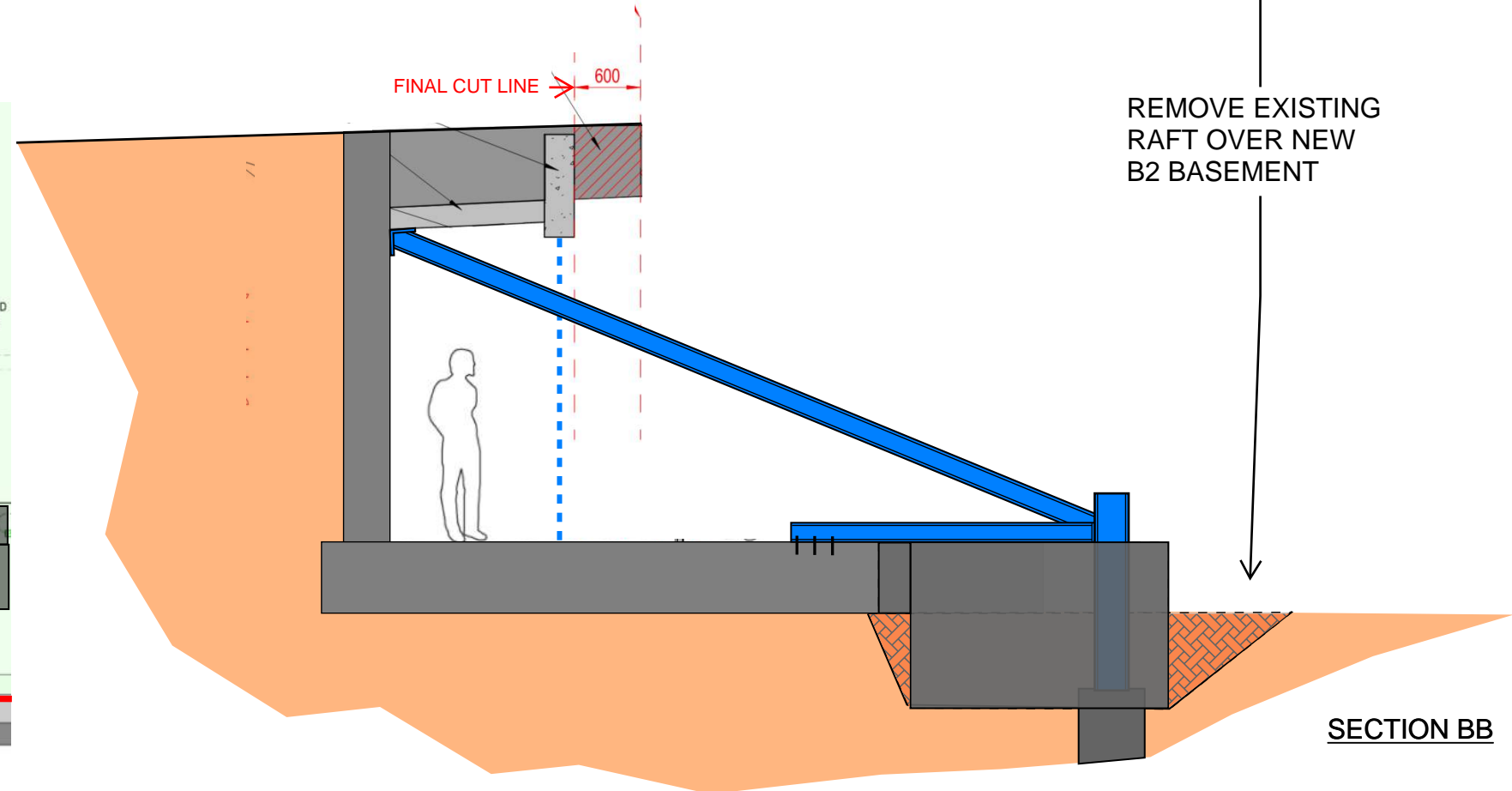
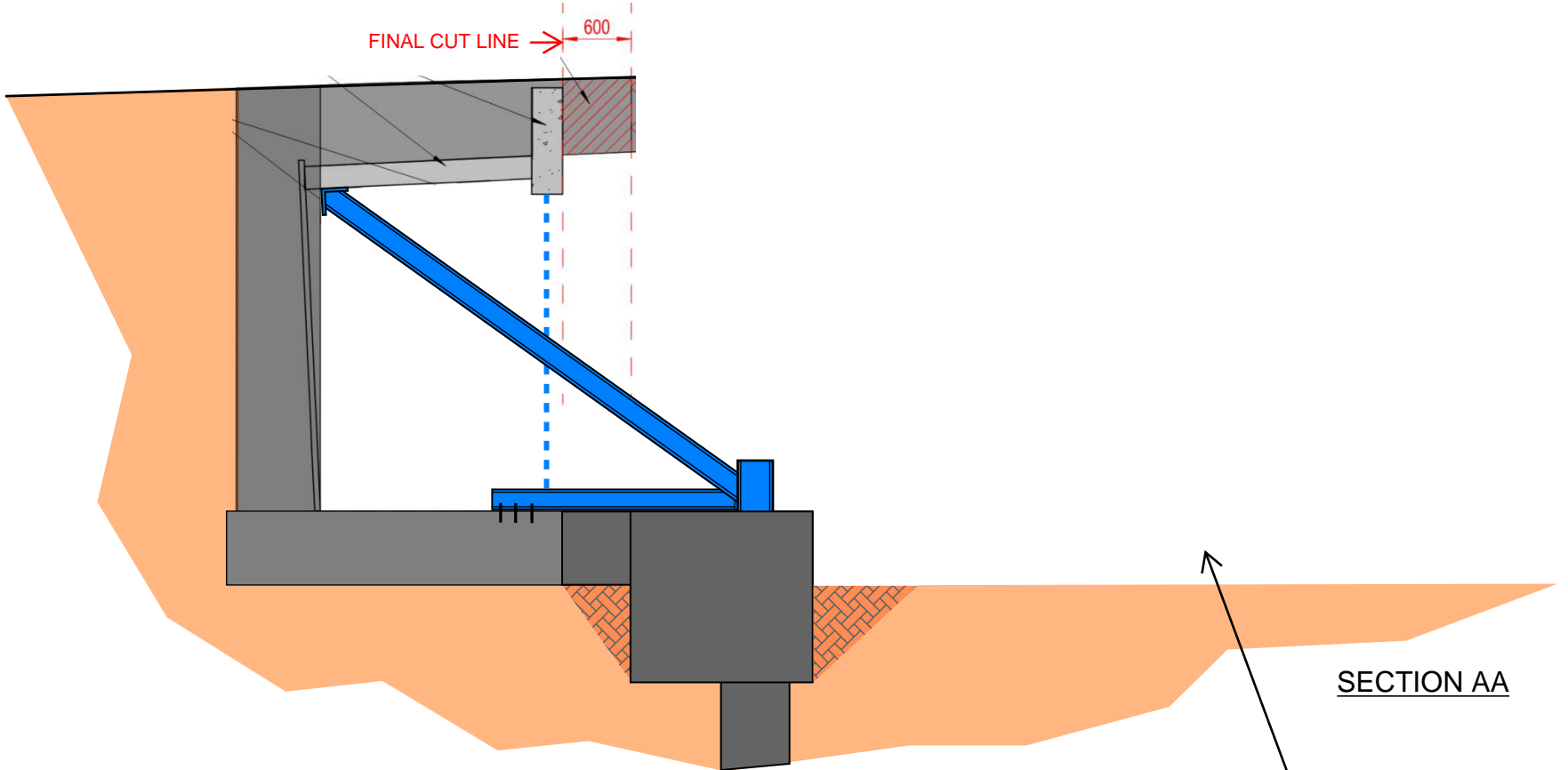
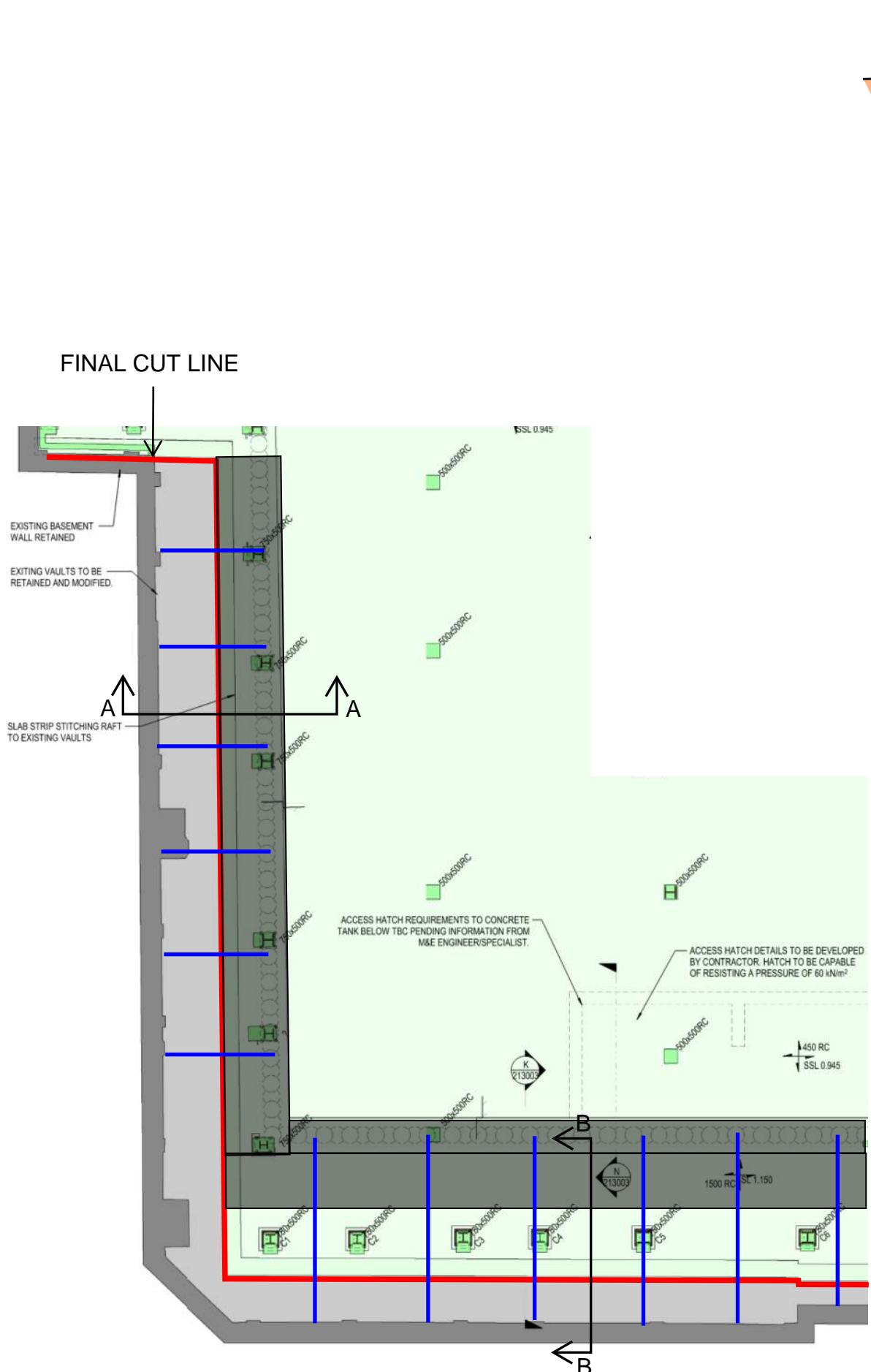
<p>McGEE A Specialist Engineering Contractor</p> <p>McGee Group (Holdings) Ltd Level 9 Alto Tower, 5 Hatfields London SE1 9PG Tel: 020 8998 1101 Fax: 020 8997 7690</p>	
--	--



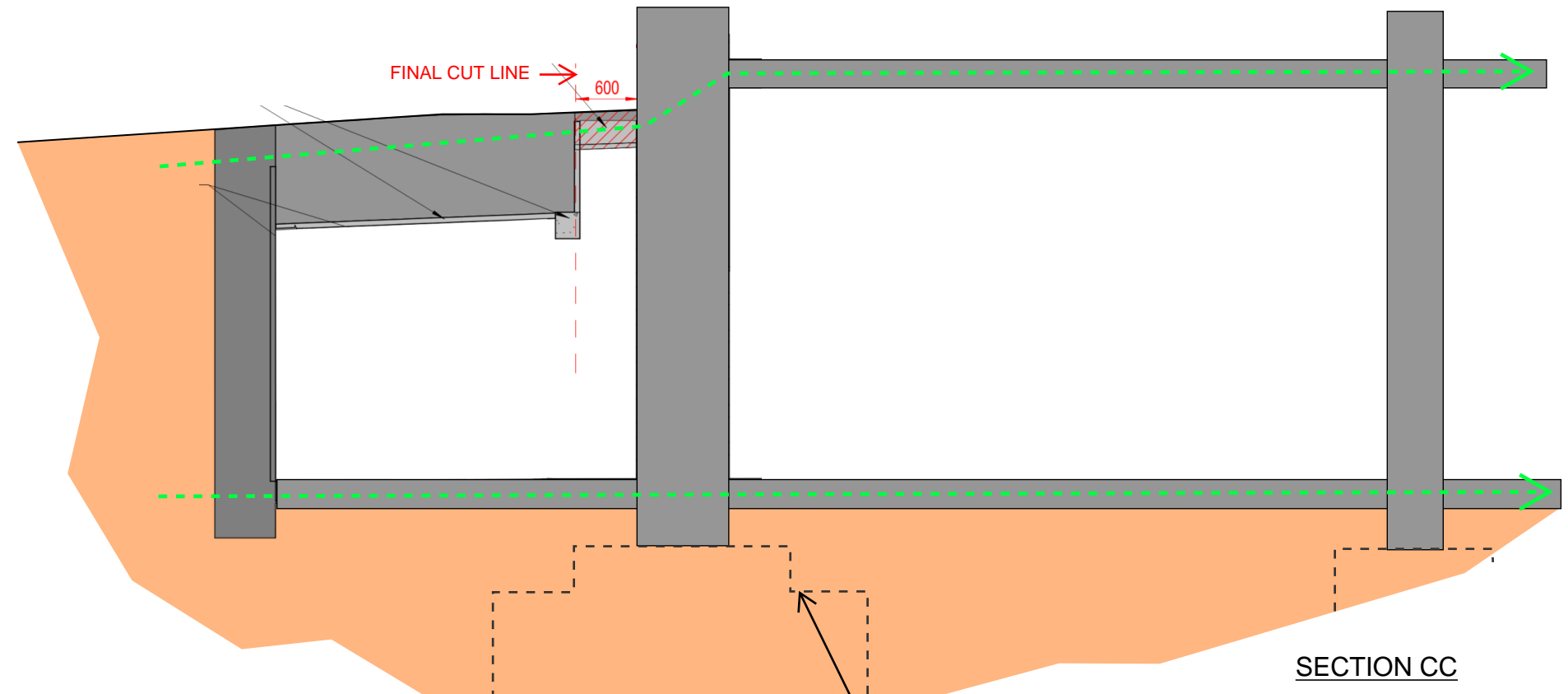
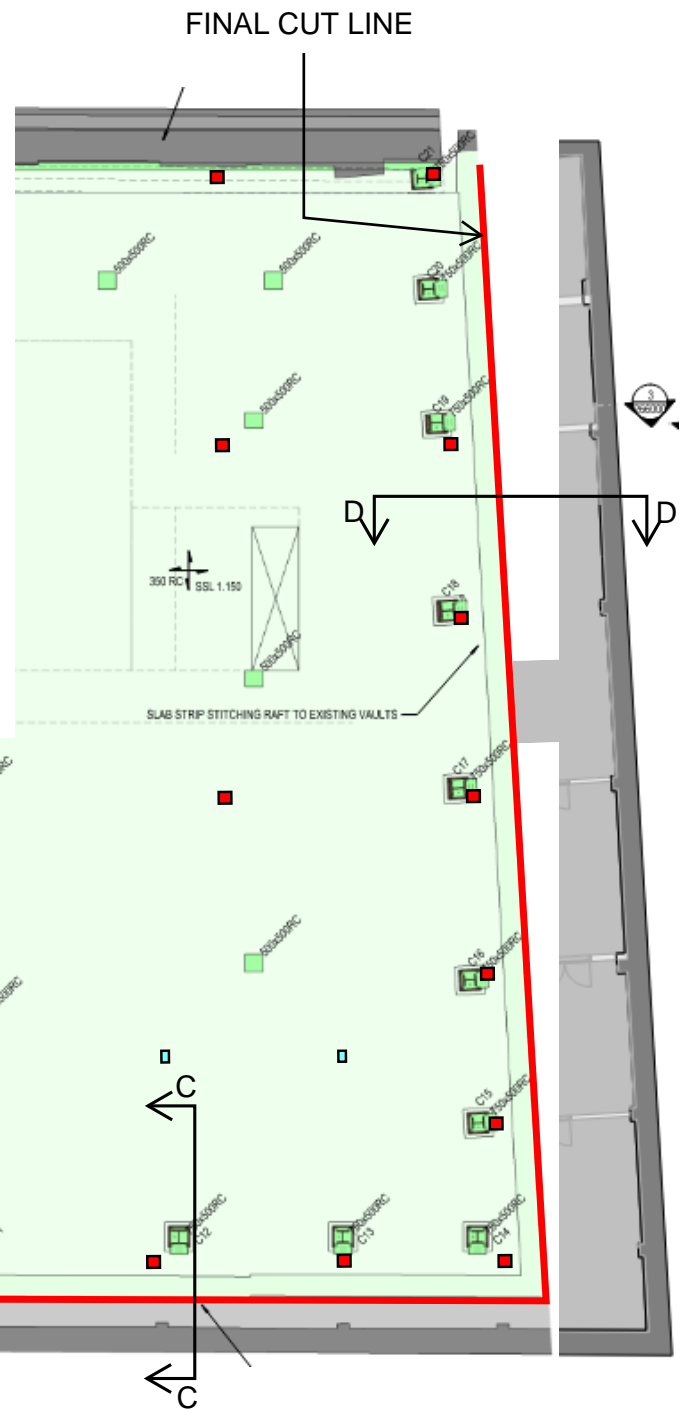

PROJECT TITLE	SKETCH TITLE	SKETCH No.	DRAWN	DATE	 <p>McGEE A Specialist Engineering Contractor</p> <p>McGee Group (Holdings) Ltd Level 9 Alto Tower, 5 Hatfields London SE1 9PG Tel: 020 8998 1101 Fax: 020 8997 7690</p>
			SCALE	REV.	

INTEGRATED TENDER BASEMENT VAULTS - EAST

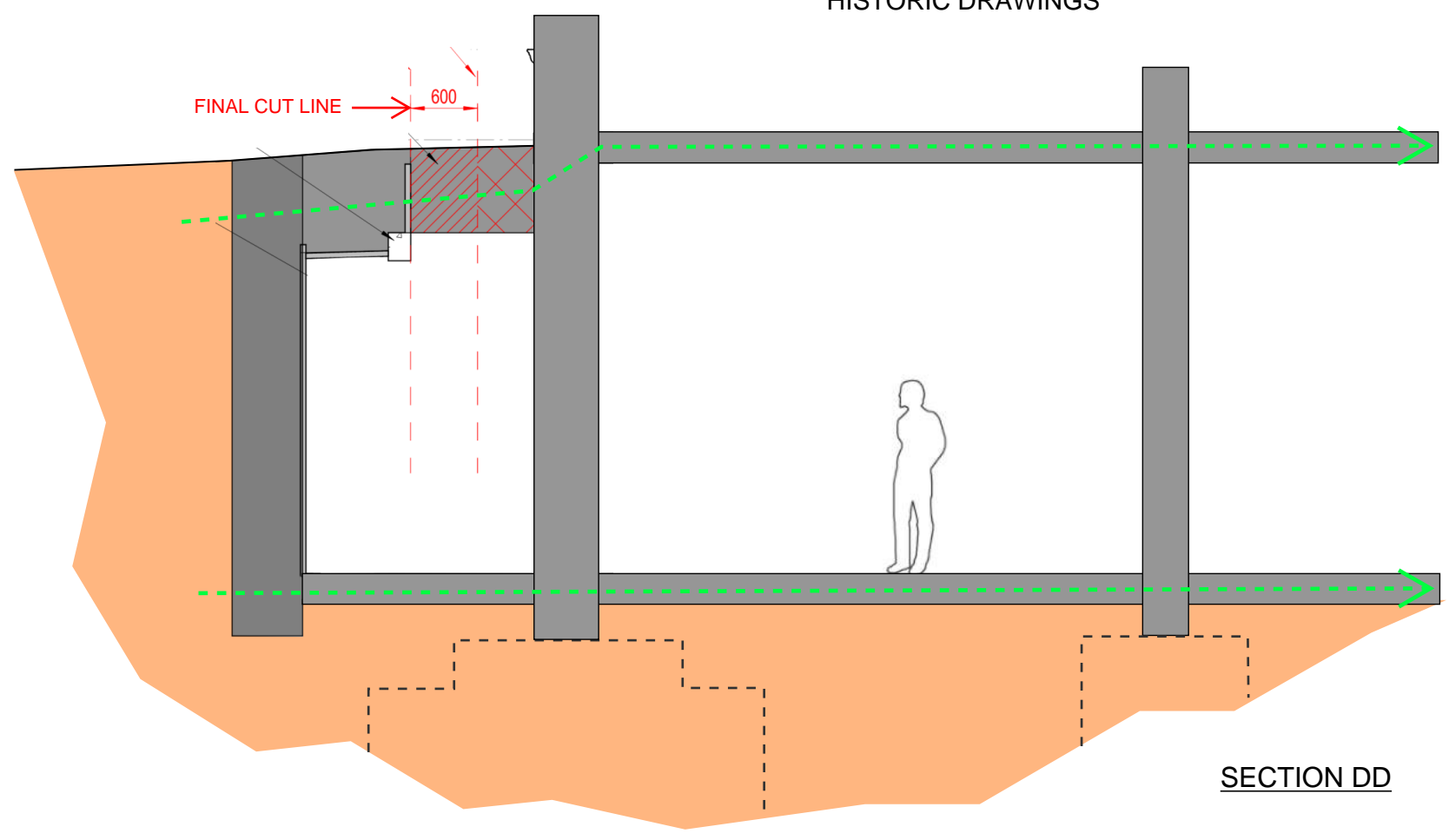

EXISTING 7 MILLBANK
PAD FOUNDATINS SHOWN
INDICATIVELY BASED ON
HISTORIC DRAWINGS



PROJECT TITLE	SKETCH TITLE	SKETCH No.	DRAWN	DATE	 <p>McGEE A Specialist Engineering Contractor McGee Group (Holdings) Ltd Level 9 Alto Tower, 5 Hatfields London SE1 9PG Tel: 020 8998 1101 Fax: 020 8997 7690</p>
			SCALE	REV.	

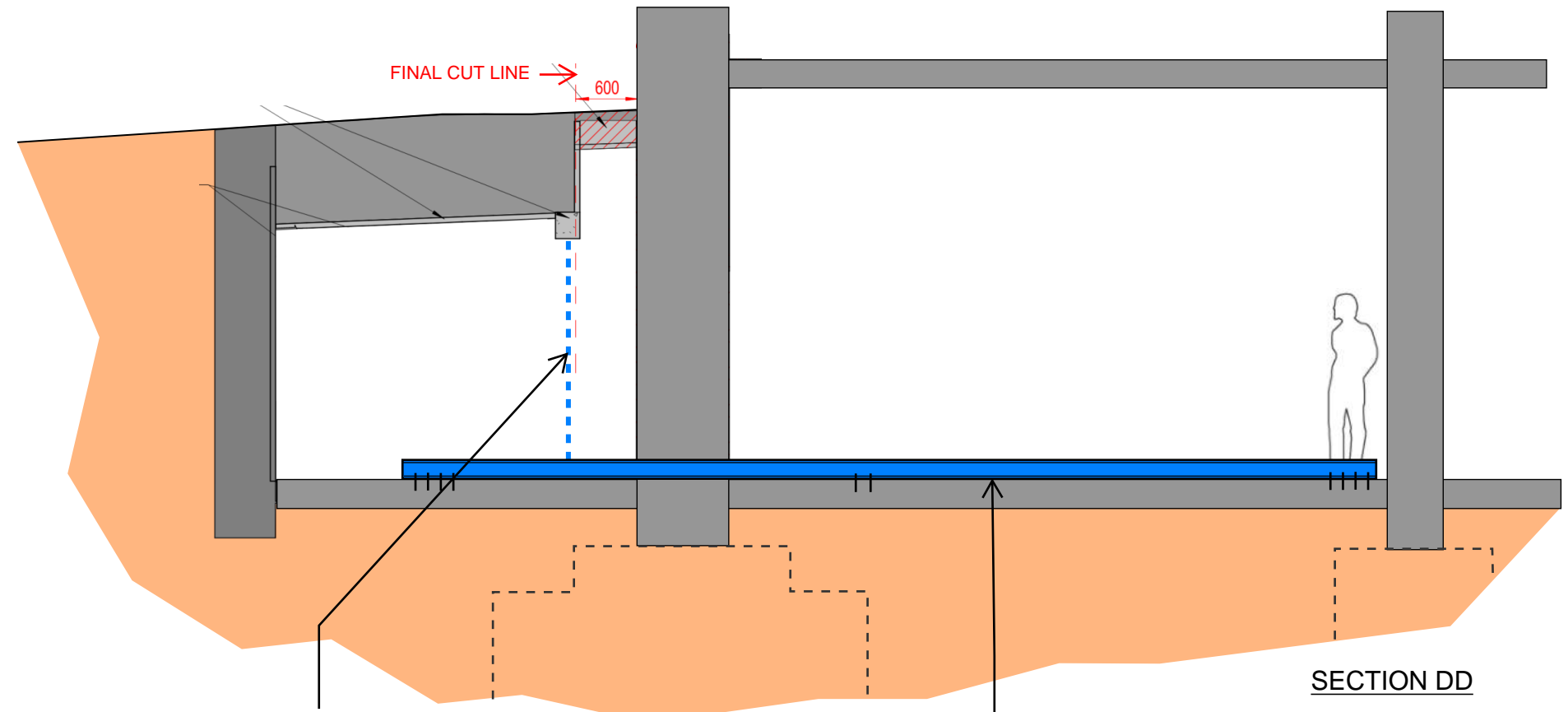
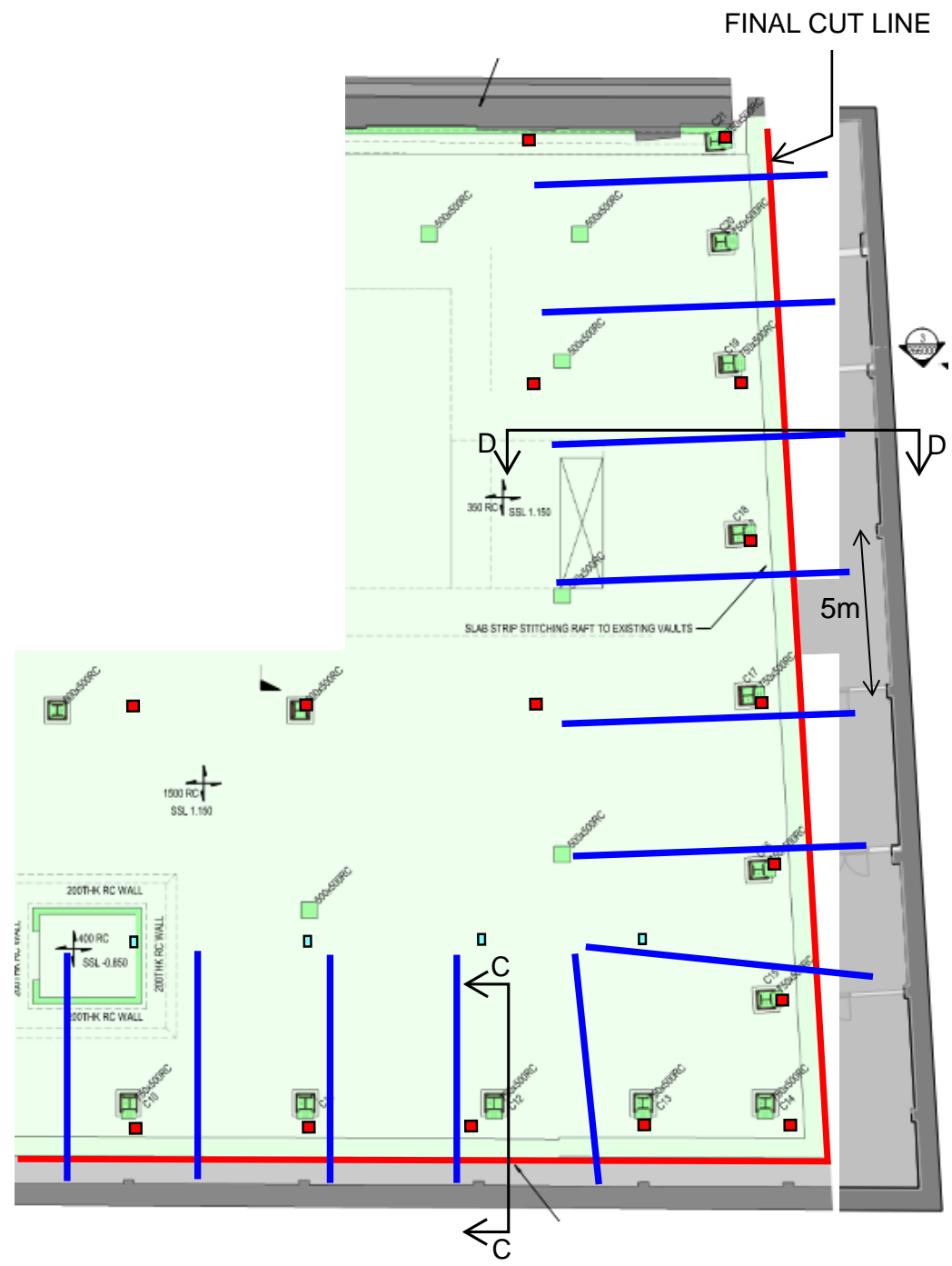

SECTION DD

VERTICAL PROPPING (PROPRIETARY PROPS 2m CENTRES) TO PAVEMENT PRIOR TO GF SLAB REMOVAL

STEEL UC203x60 HORIZONTAL PROPPING TO MAINTAIN B1 SUPPORT TO THE VAULTS DURING NEW RAFT SLAB INSTALLATION

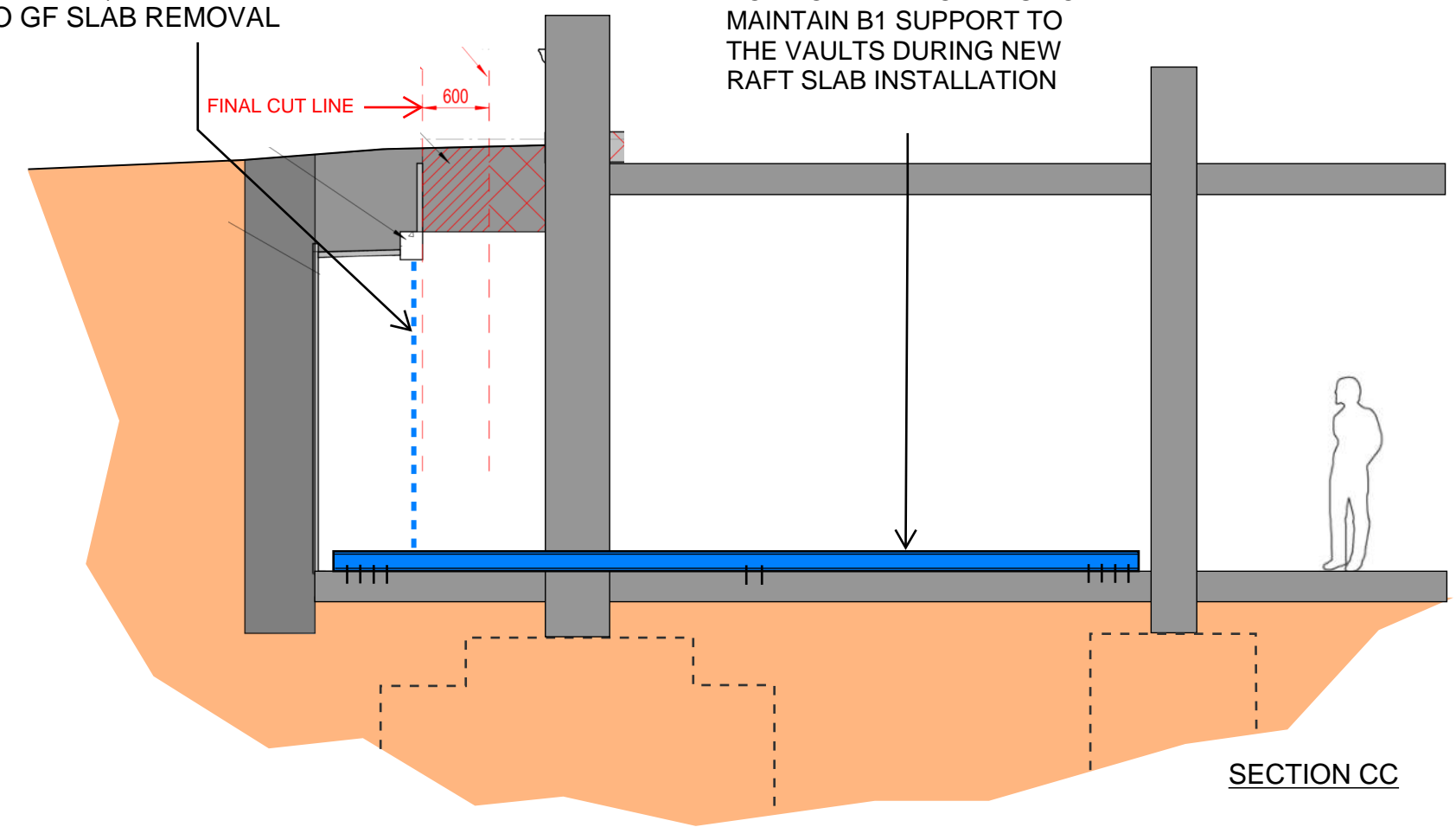

SECTION CC

PROJECT TITLE	SKETCH TITLE	SKETCH No.	DRAWN	DATE	 <p>McGEE A Specialist Engineering Contractor McGee Group (Holdings) Ltd Level 9 Alto Tower, 5 Hatfields London SE1 9PG Tel: 020 8998 1101 Fax: 020 8997 7690</p>
			SCALE	REV.	

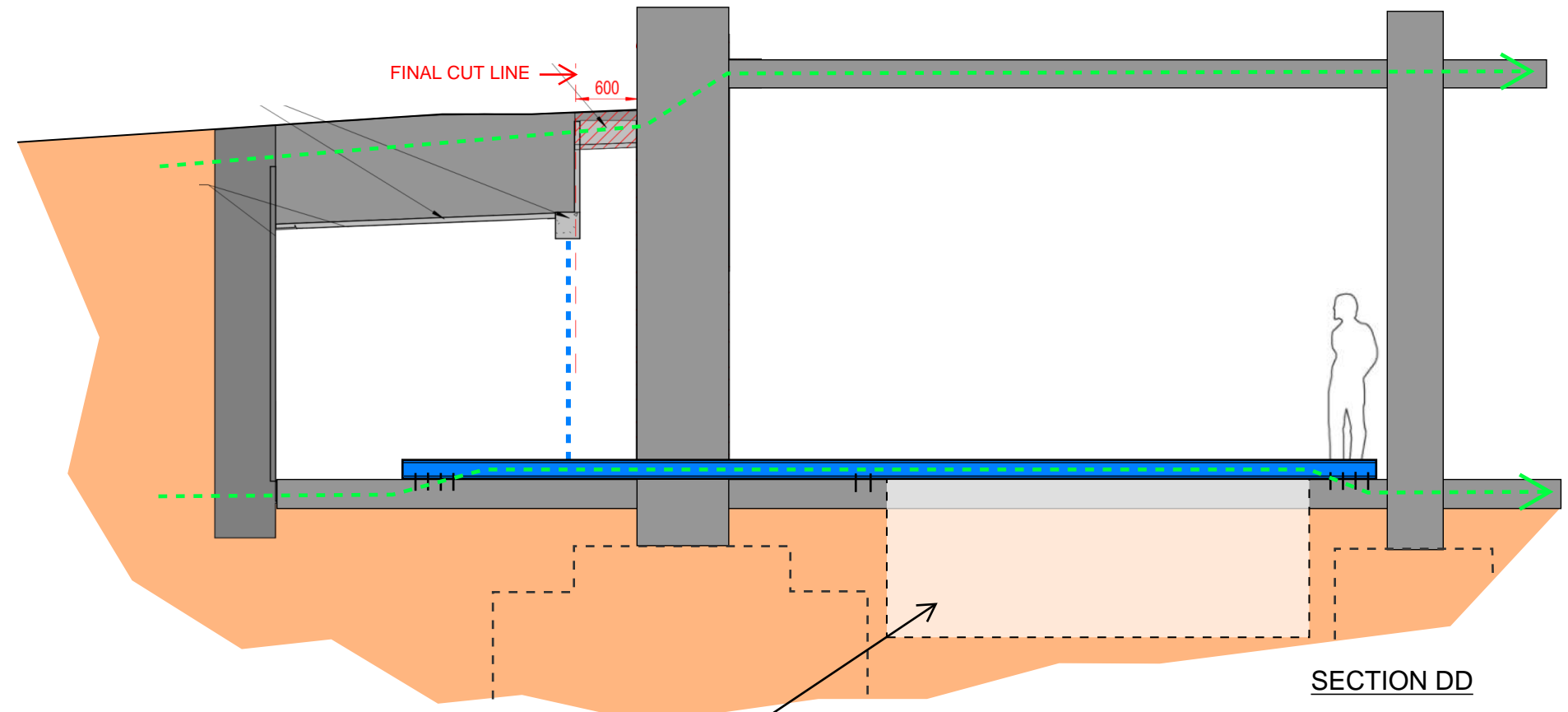
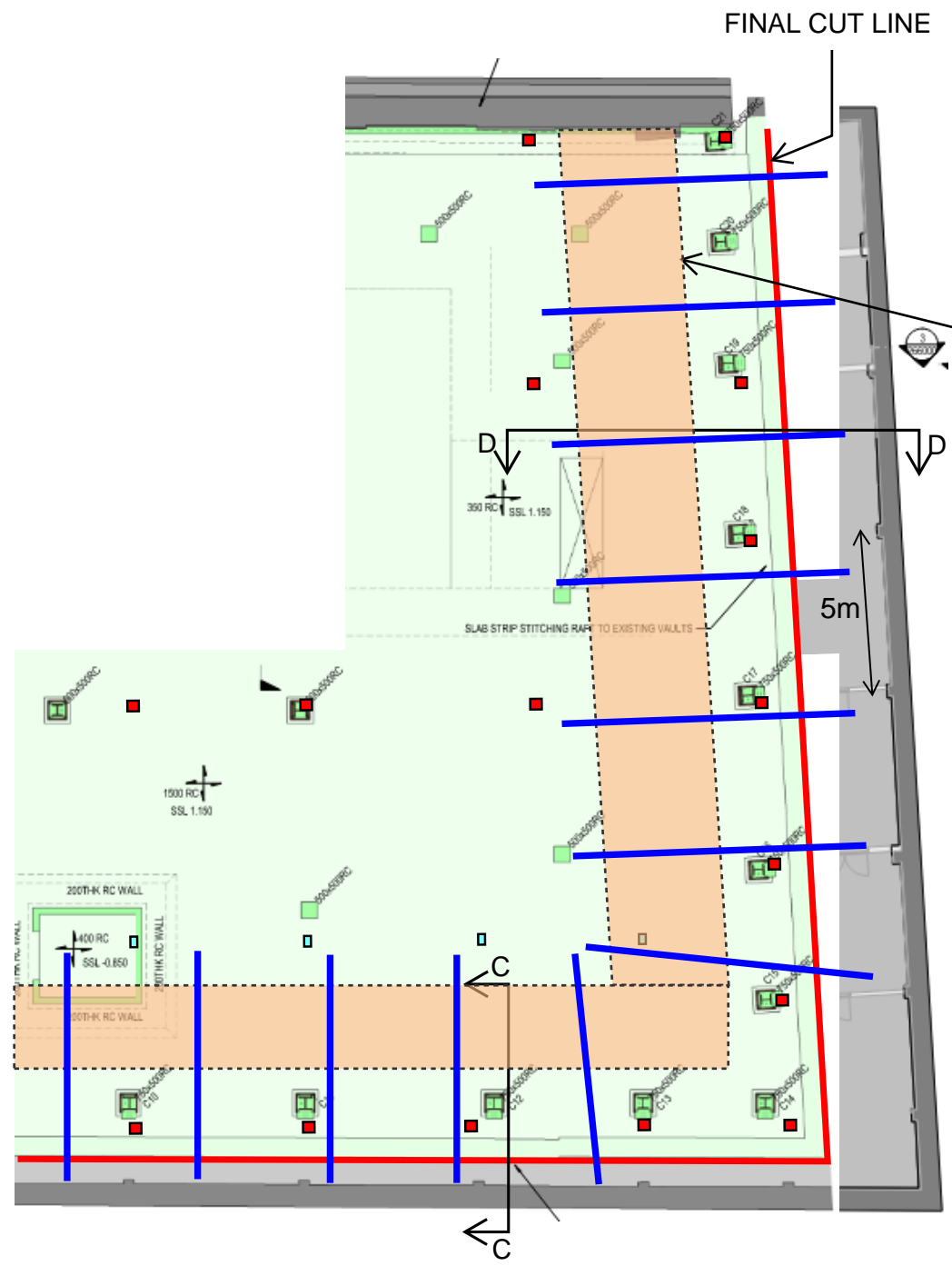

SLAB ENABLING/REMOVAL TO AVOID EXISTING FOUNDATIONS FOR EARLY INSTALLATION OF NEW PERMANENT RAFT STRIP

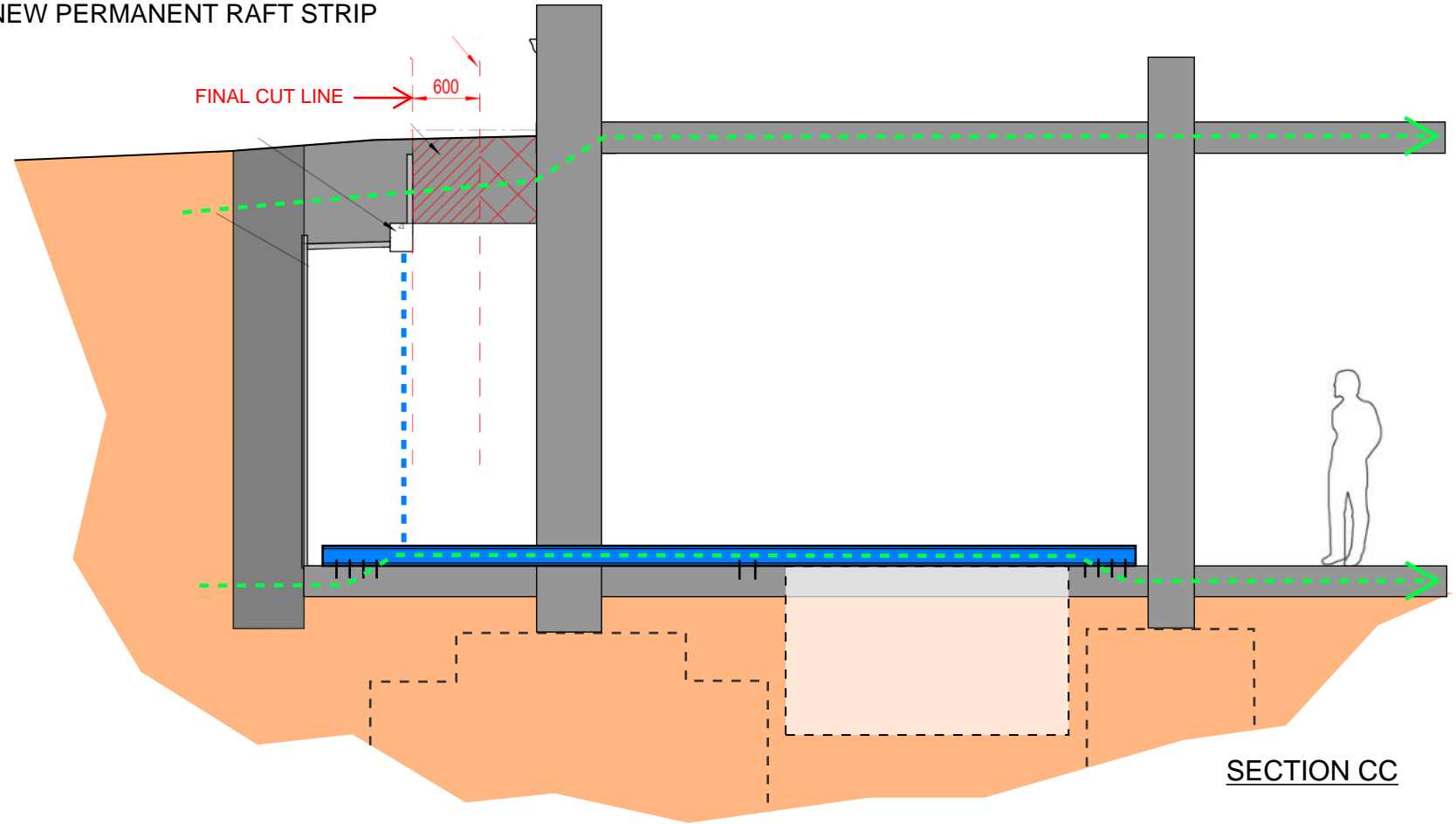



PROJECT TITLE	SKETCH TITLE

SKETCH No.

DRAWN	DATE
SCALE	REV.

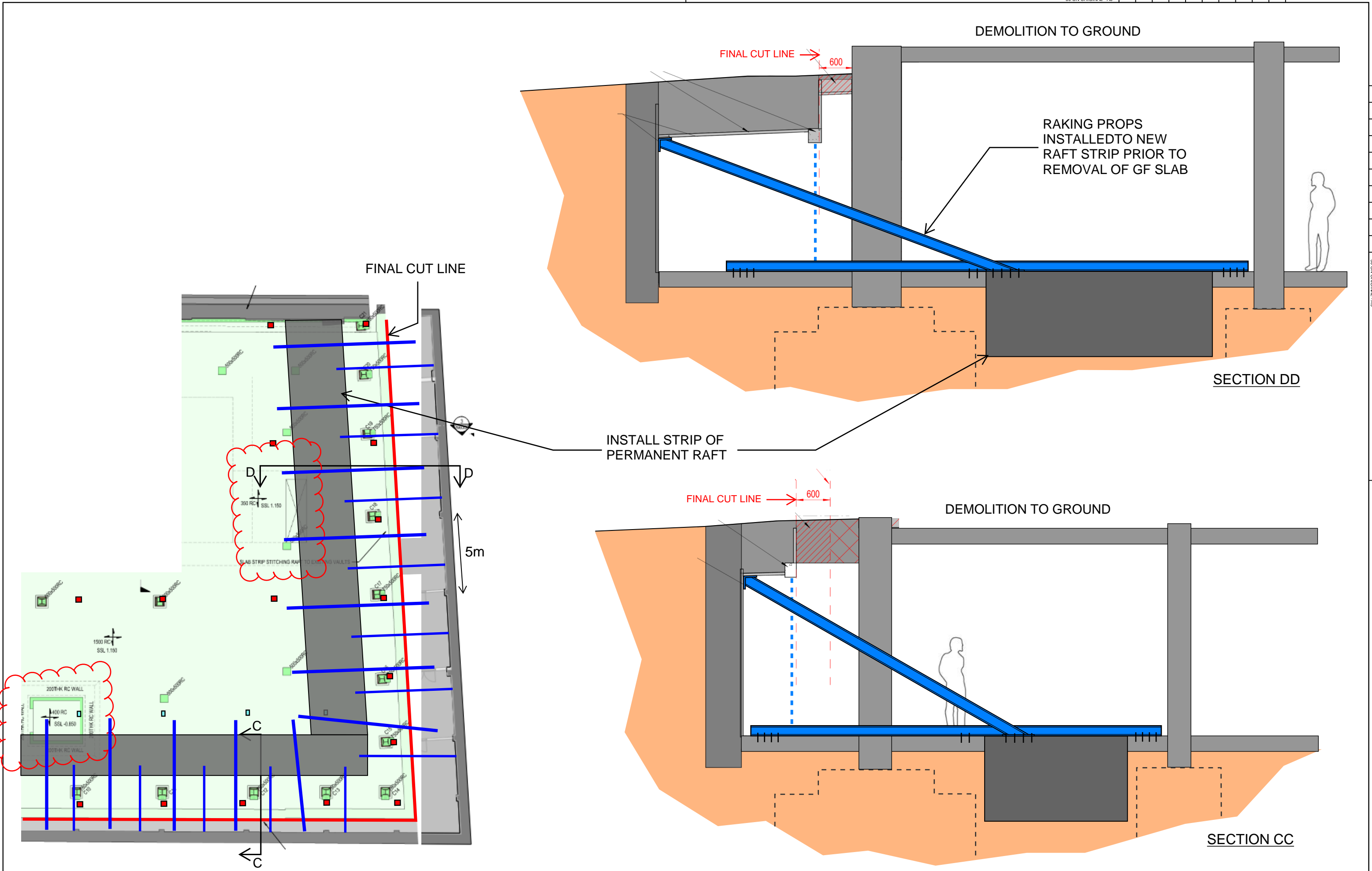
McGEE
 A Specialist Engineering Contractor
 McGee Group (Holdings) Ltd
 Level 9 Alto Tower, 5 Hatfields
 London SE1 9PG
 Tel: 020 8998 1101 Fax: 020 8997 7690



PROJECT TITLE	SKETCH TITLE	SKETCH No.	DRAWN	DATE	 <p>McGEE A Specialist Engineering Contractor McGee Group (Holdings) Ltd Level 9 Alto Tower, 5 Hatfields London SE1 9PG Tel: 020 8998 1101 Fax: 020 8997 7690</p>
			SCALE	REV.	

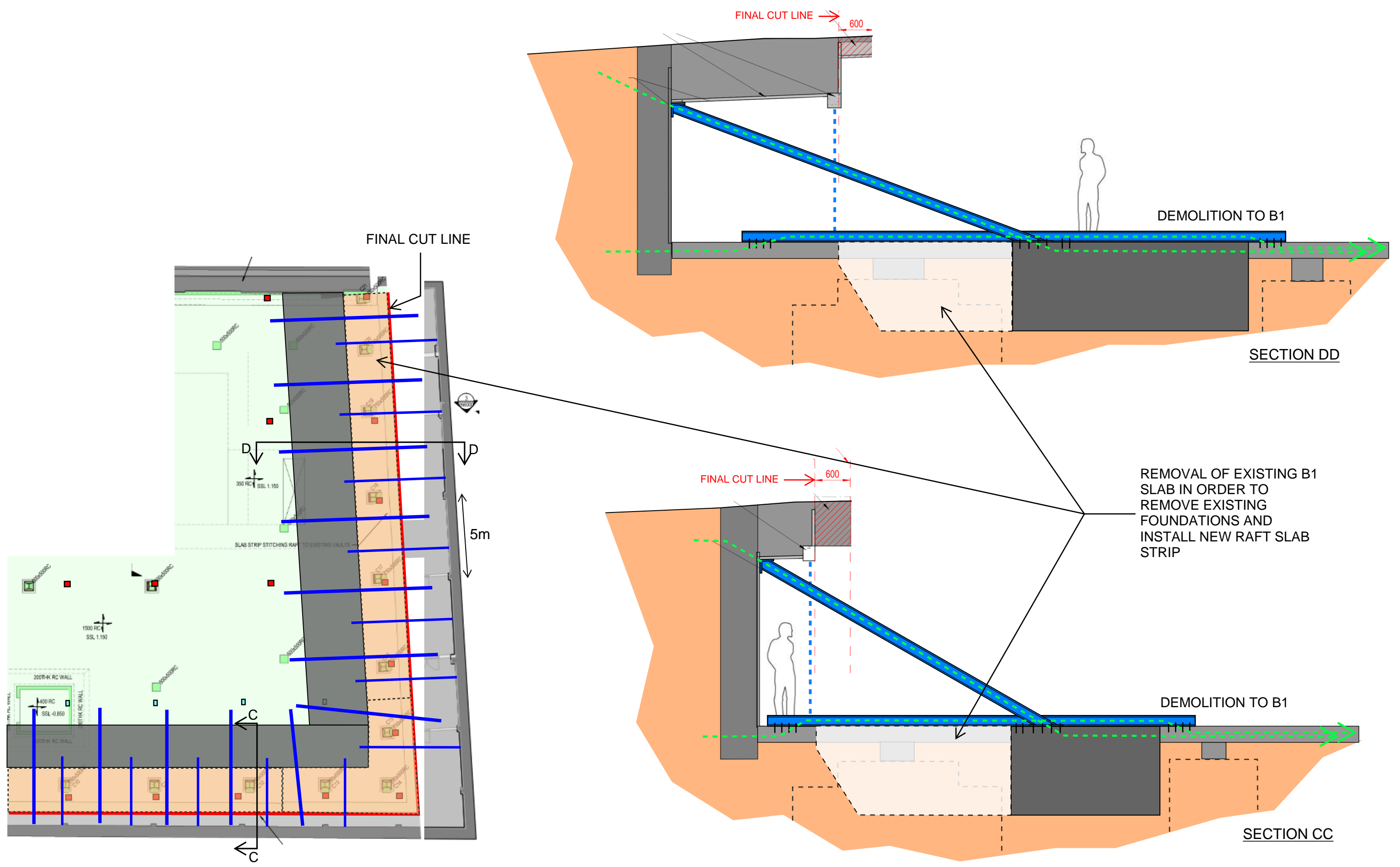

PROJECT TITLE	SKETCH TITLE	SKETCH No.	DRAWN	DATE	 <p>McGEE A Specialist Engineering Contractor McGee Group (Holdings) Ltd Level 9 Alto Tower, 5 Hatfields London SE1 9PG Tel: 020 8998 1101 Fax: 020 8997 7690</p>
			SCALE	REV.	

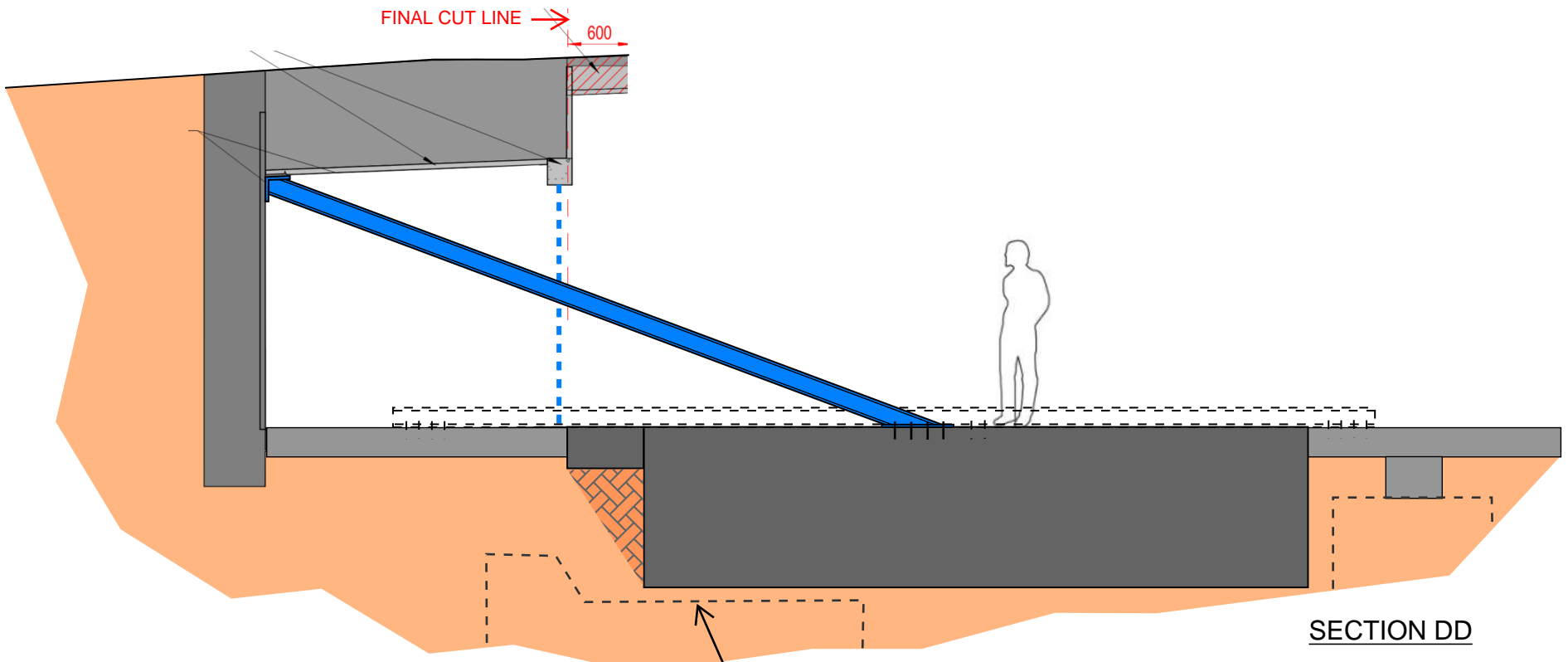
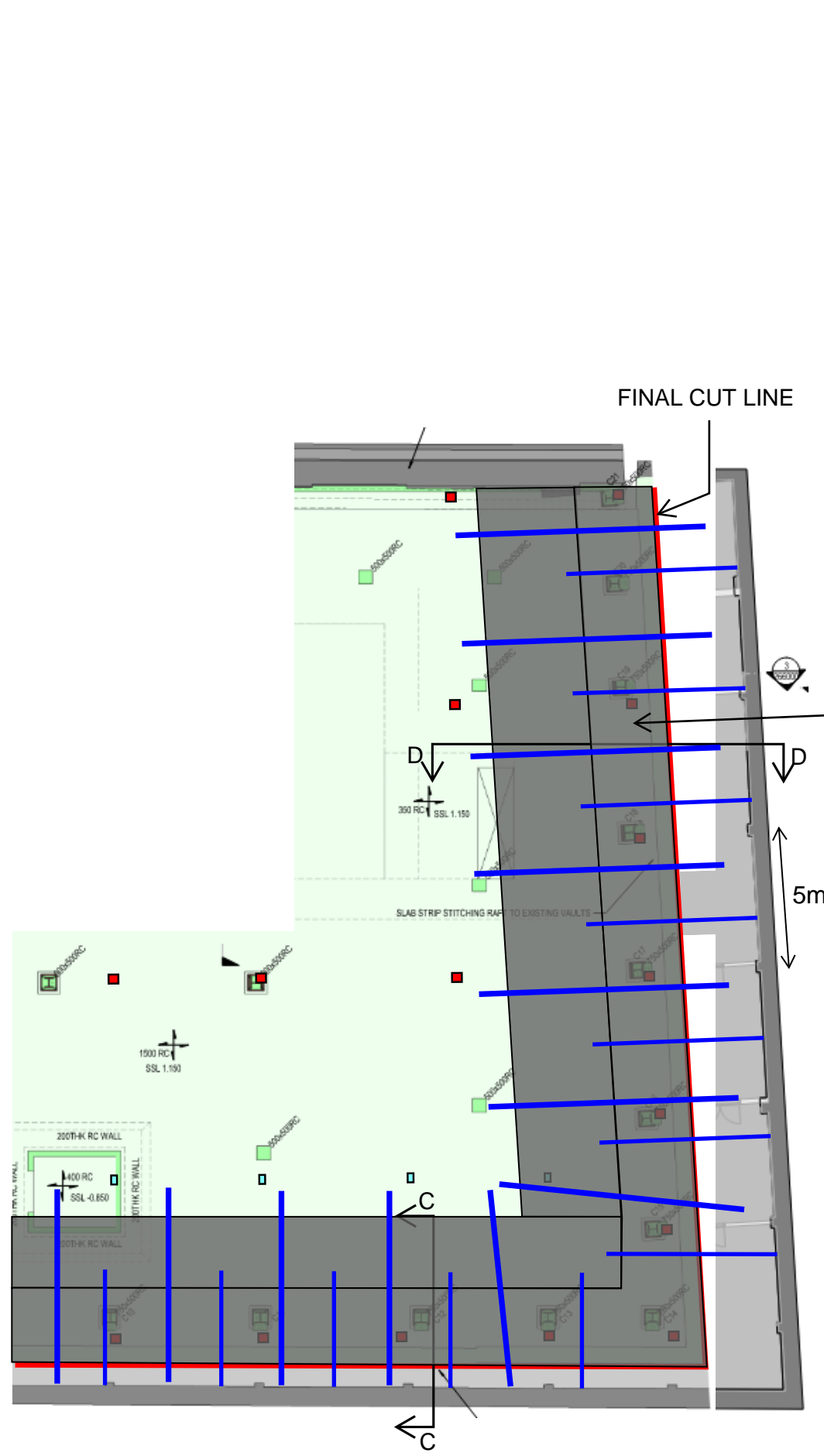

COMPLETE IN-FILLS FOR EARLY RAFT SLAB

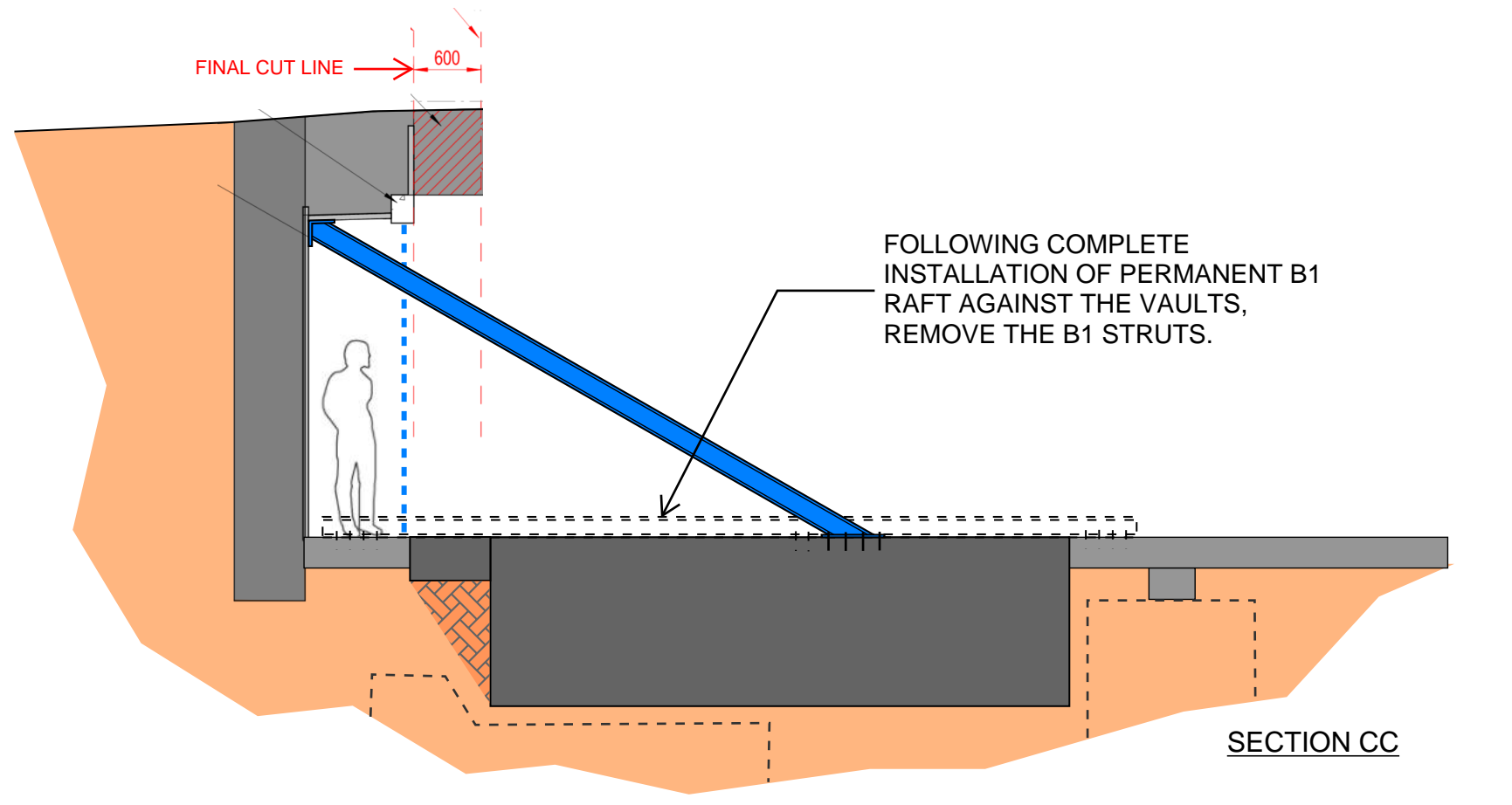

PROJECT TITLE	SKETCH TITLE	SKETCH No.	DRAWN	DATE	 <p>McGEE A Specialist Engineering Contractor McGee Group (Holdings) Ltd Level 9 Alto Tower, 5 Hatfields London SE1 9PG Tel: 020 8998 1101 Fax: 020 8997 7690</p>
			SCALE	REV.	

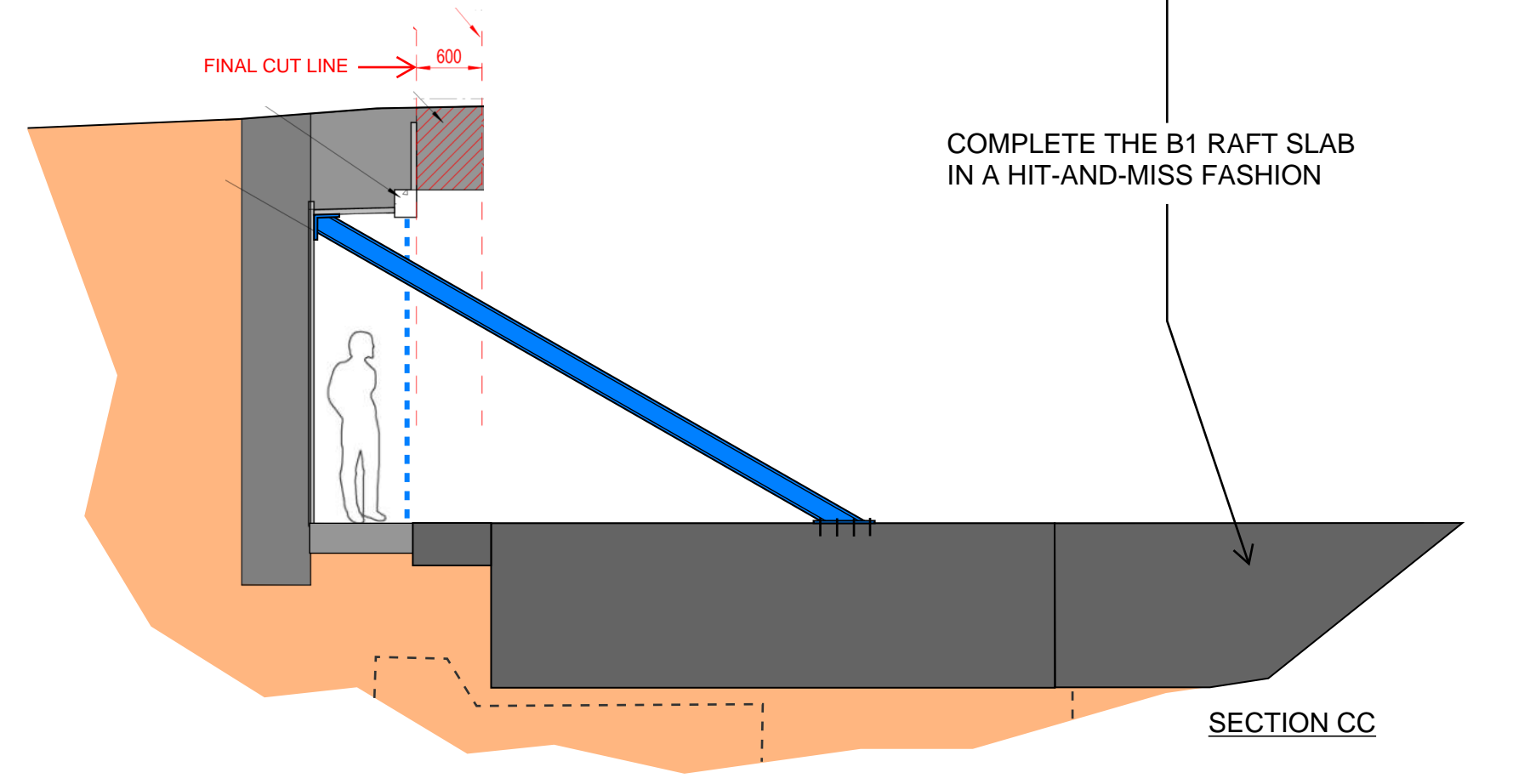
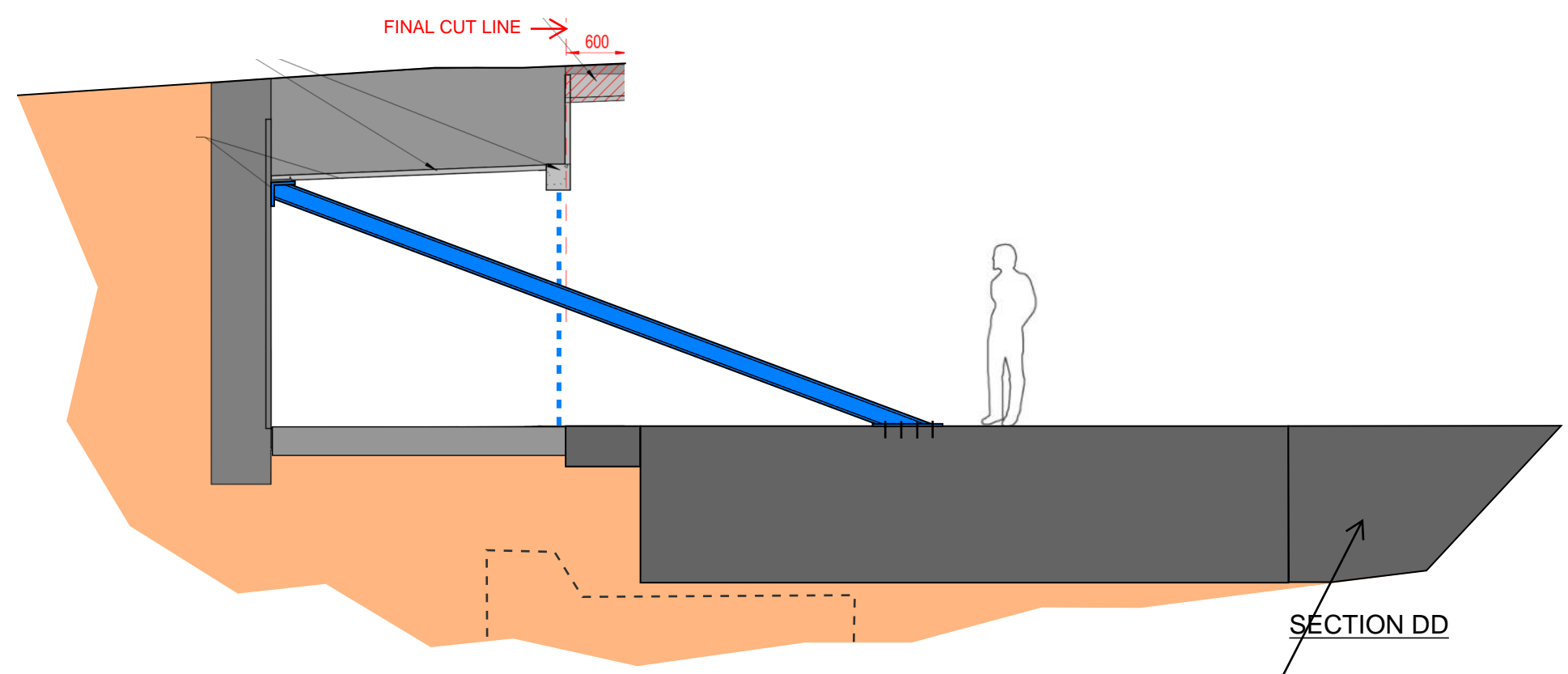
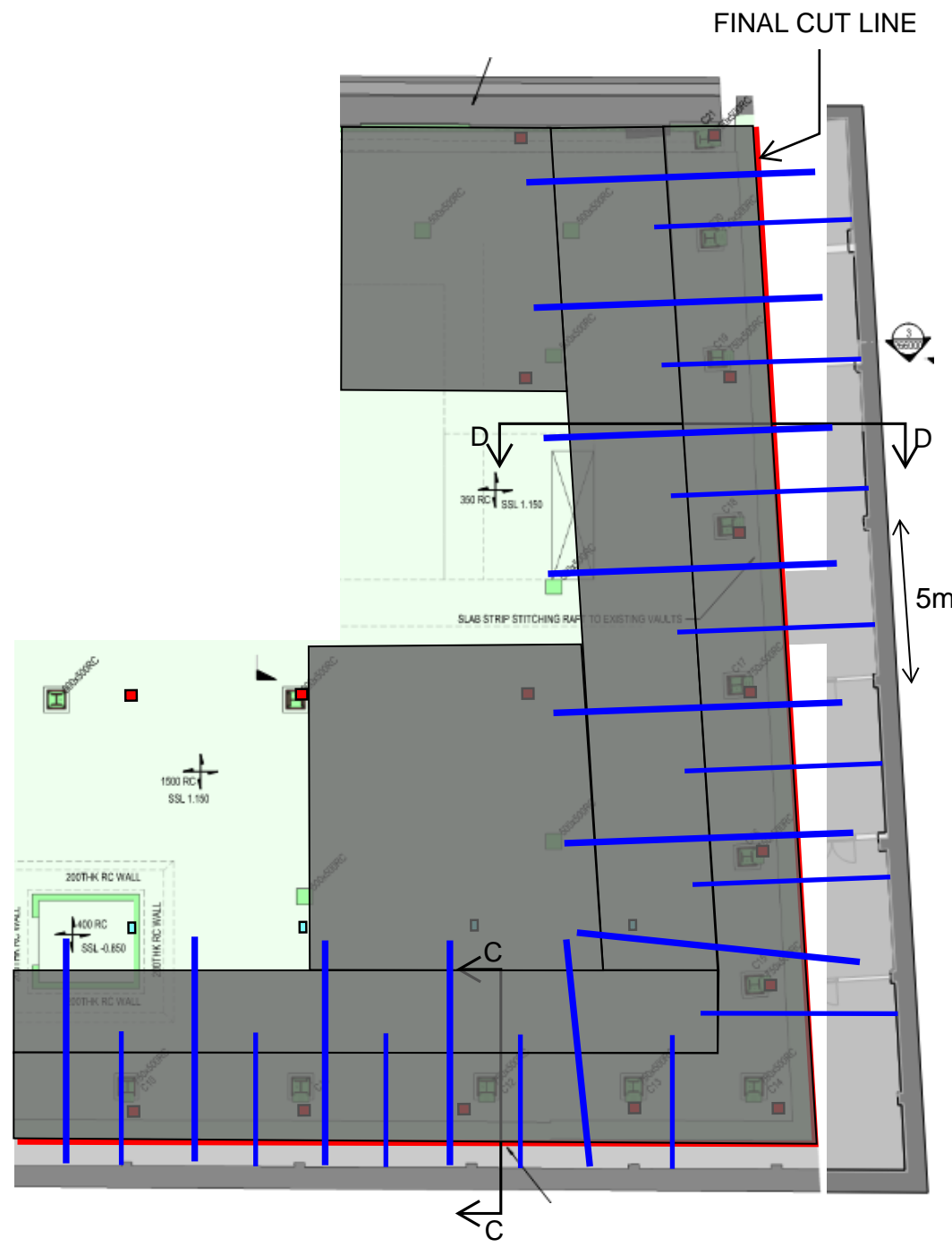

COMPLETE THE B1 RAFT SLAB
IN A HIT-AND-MISS FASHION

PROJECT TITLE	SKETCH TITLE	SKETCH No.	DRAWN	DATE	 <p>McGEE A Specialist Engineering Contractor McGee Group (Holdings) Ltd Level 9 Alto Tower, 5 Hatfields London SE1 9PG Tel: 020 8998 1101 Fax: 020 8997 7690</p>
			SCALE	REV.	

BASEMENT TENDER

BASEMENT VAULTS - WEST

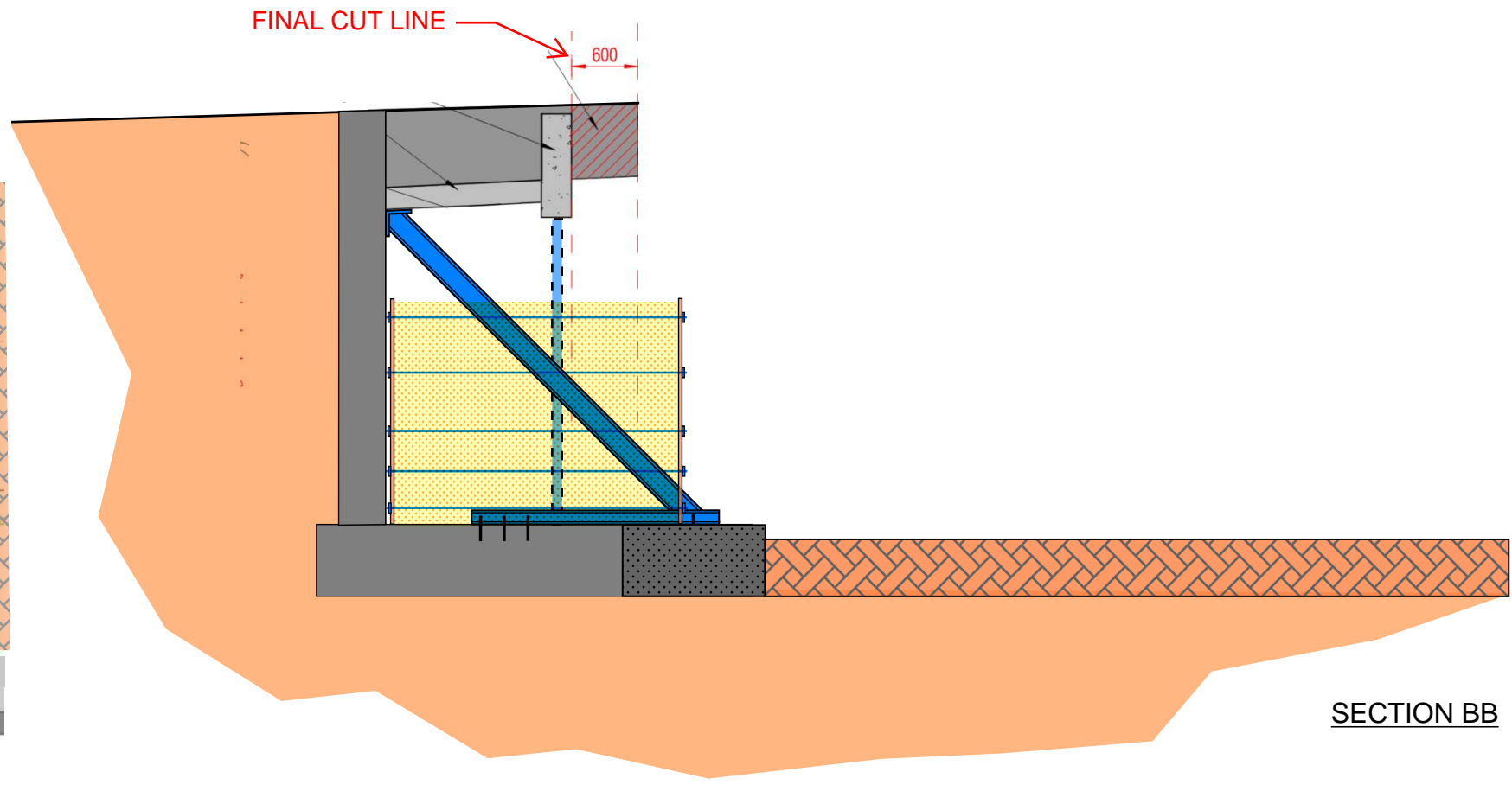
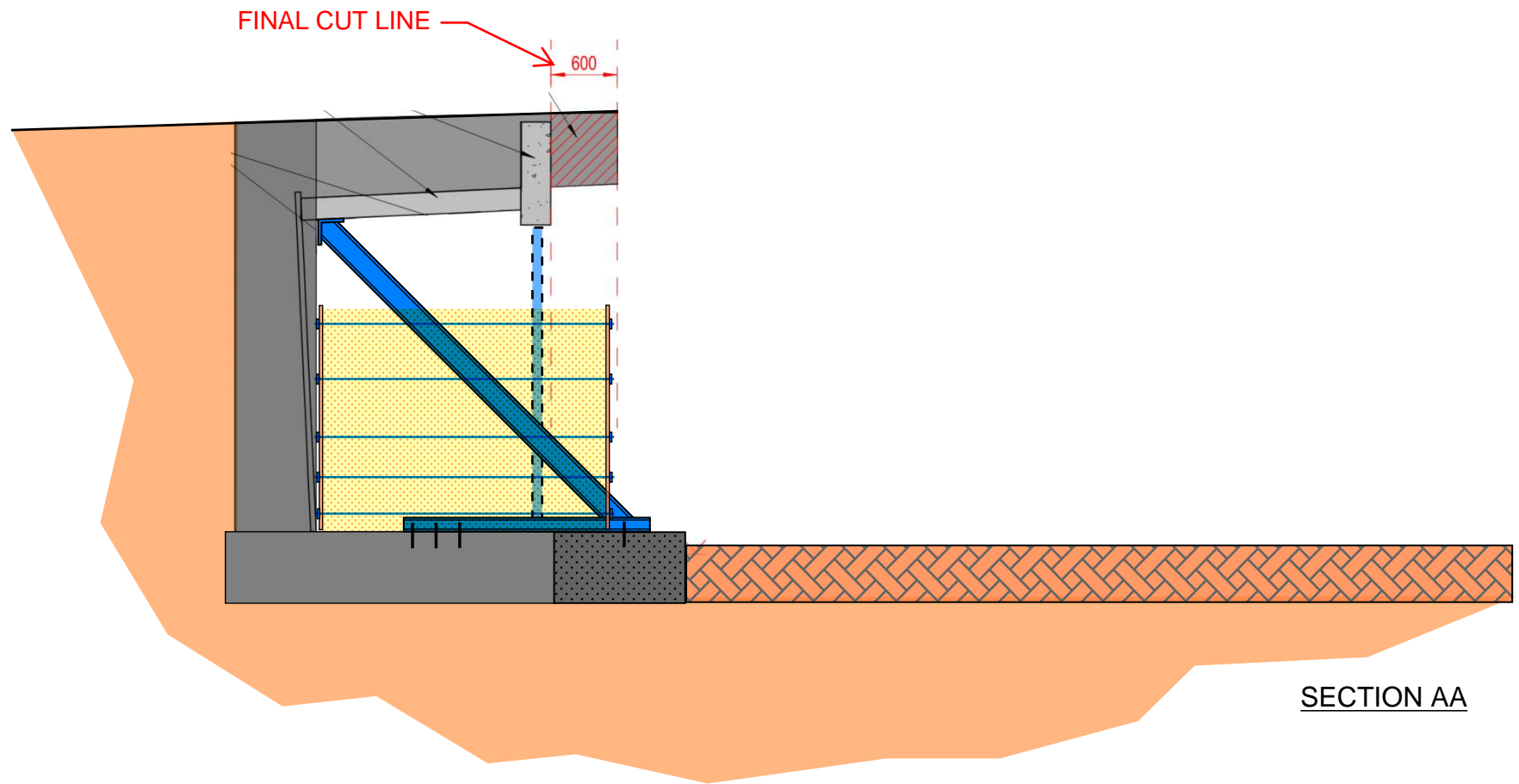
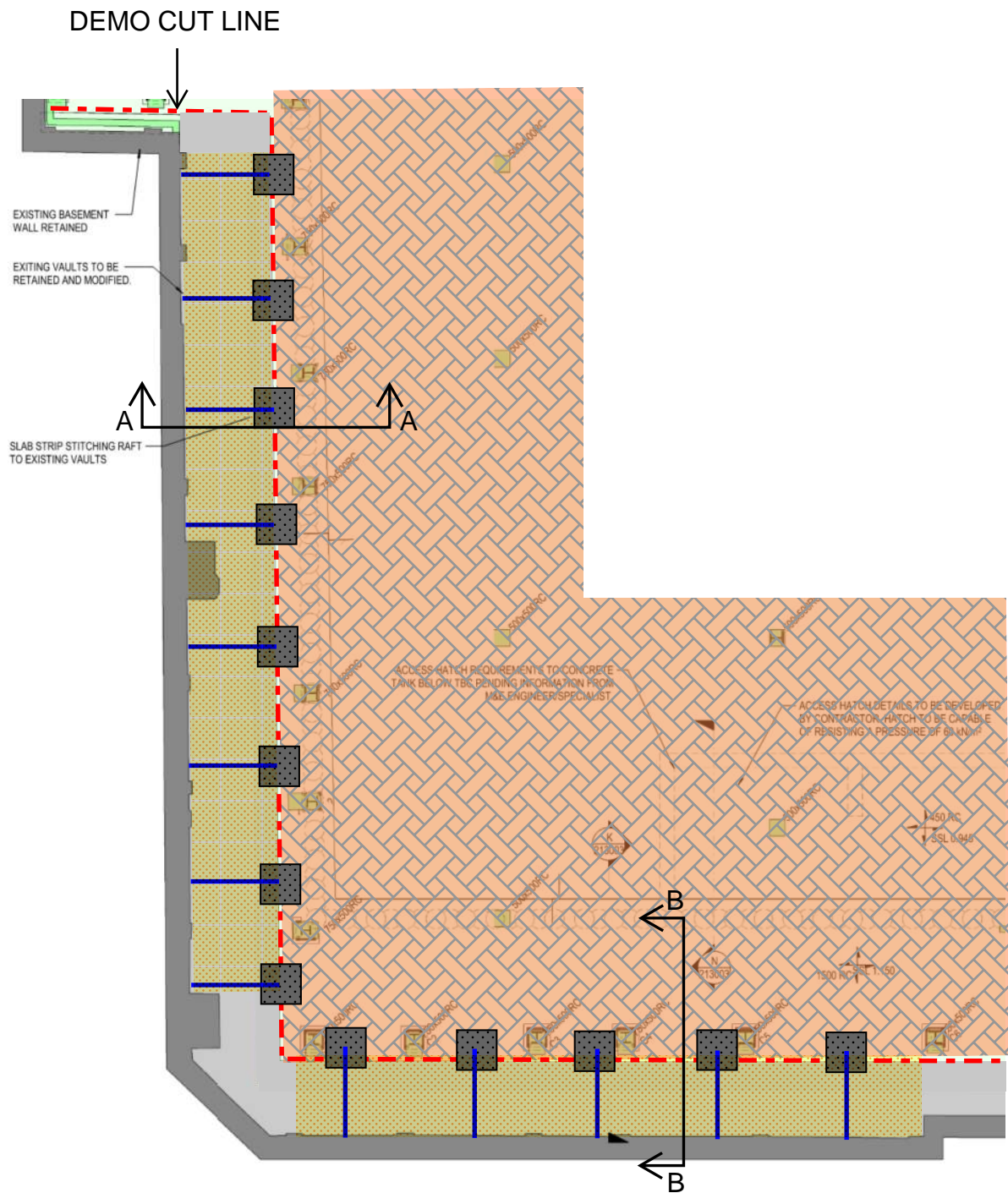

PROJECT TITLE	SKETCH TITLE	SKETCH No.	DRAWN	DATE
			SCALE	REV.

McGEE
A Specialist Engineering Contractor

McGee Group (Holdings) Ltd
Level 9 Alto Tower, 5 Hatfields
London SE1 9PG
Tel: 020 8998 1101 Fax: 020 8997 7690

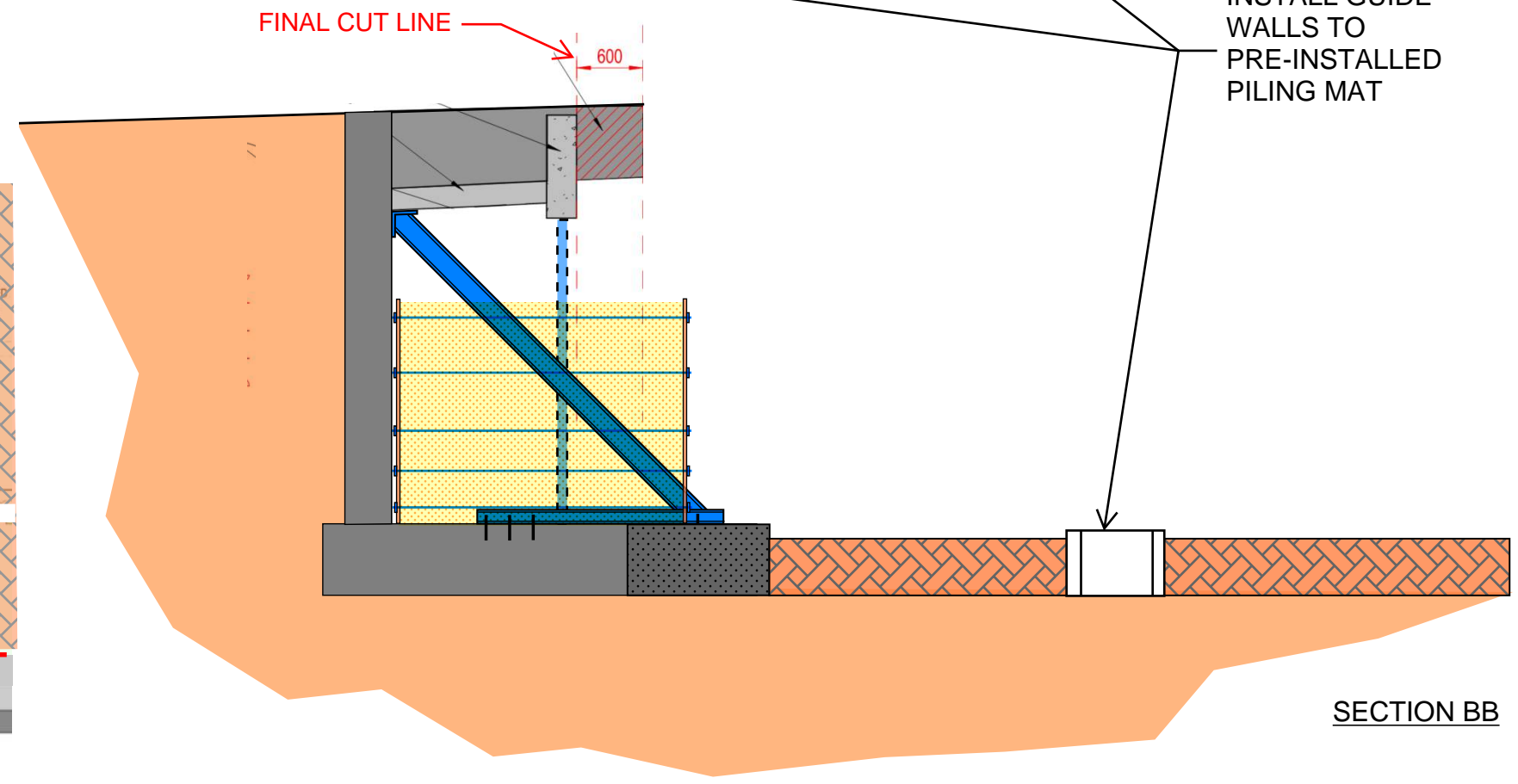
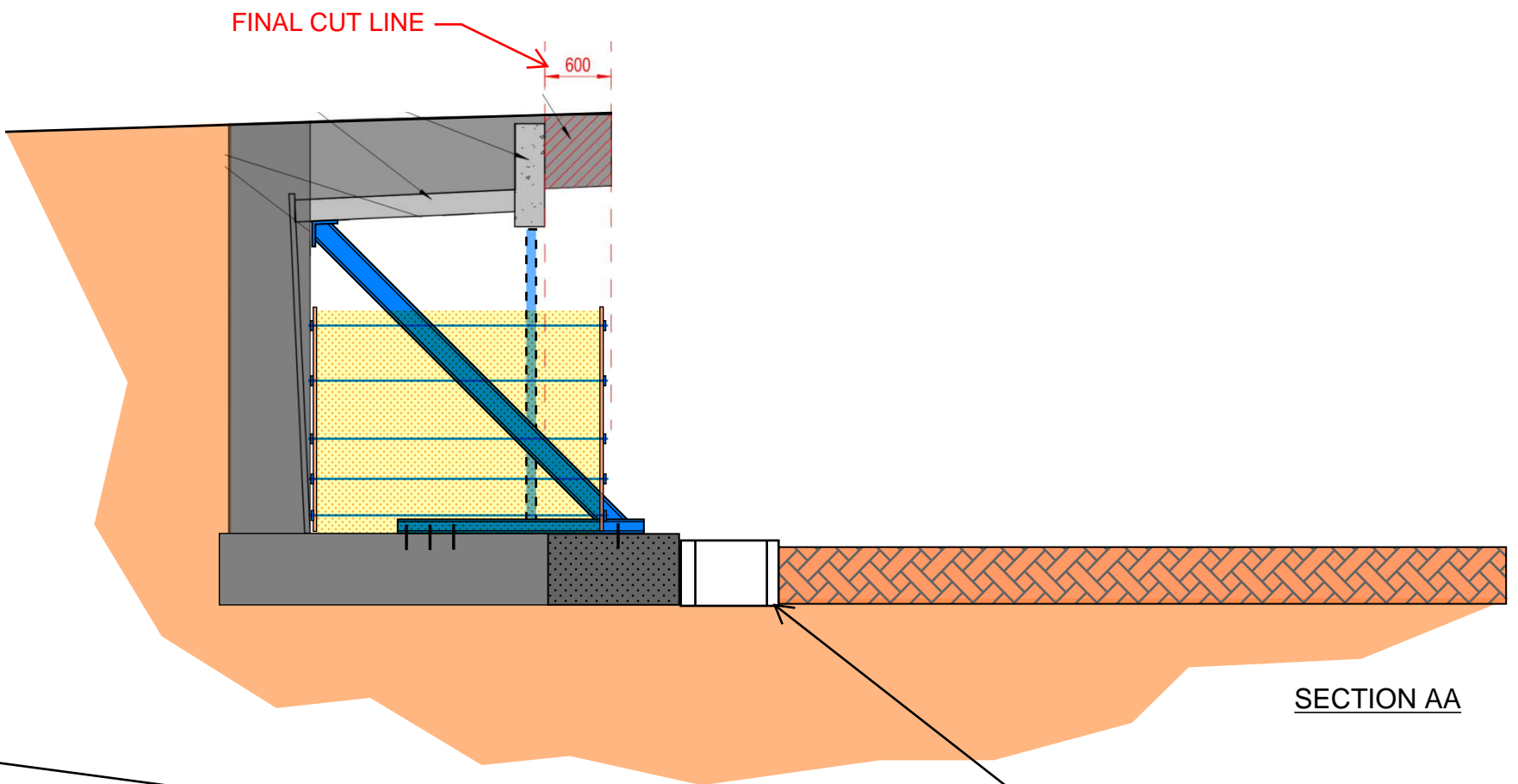
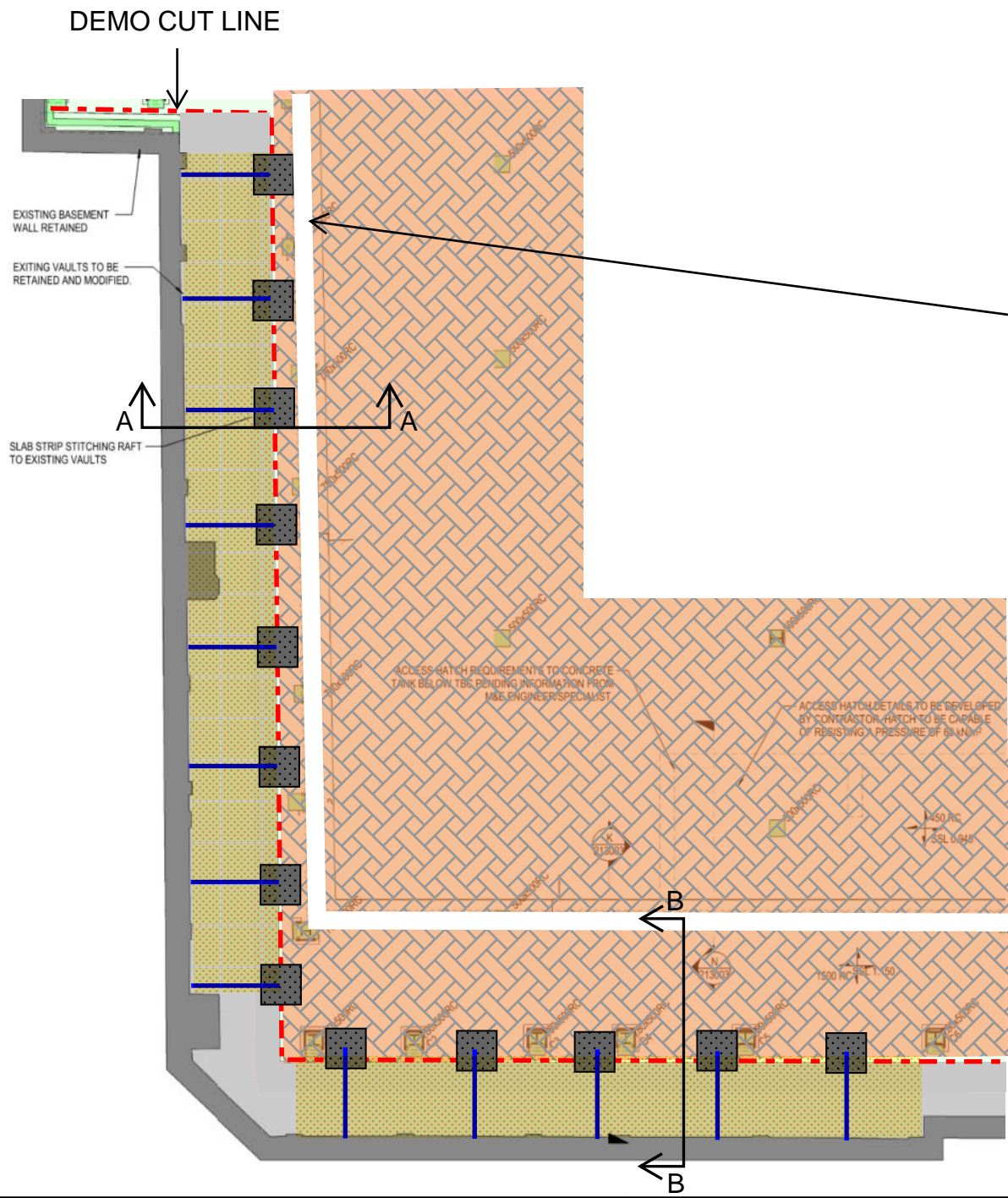

PROJECT TITLE	SKETCH TITLE

SKETCH No.	DRAWN	DATE

SCALE	REV.

McGEE
 A Specialist Engineering Contractor
 McGee Group (Holdings) Ltd
 Level 9 Alto Tower, 5 Hatfields
 London SE1 9PG
 Tel: 020 8998 1101 Fax: 020 8997 7690

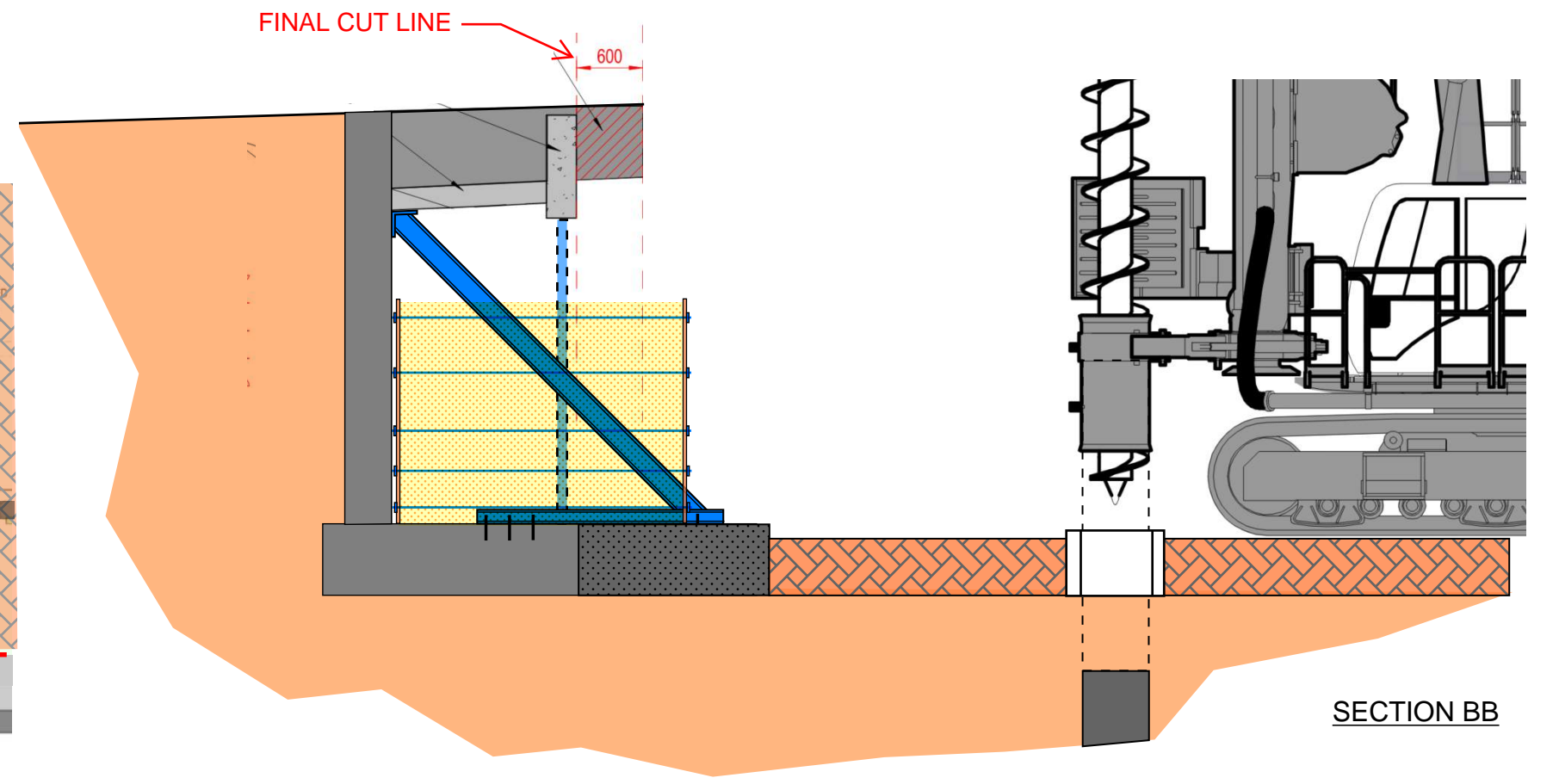
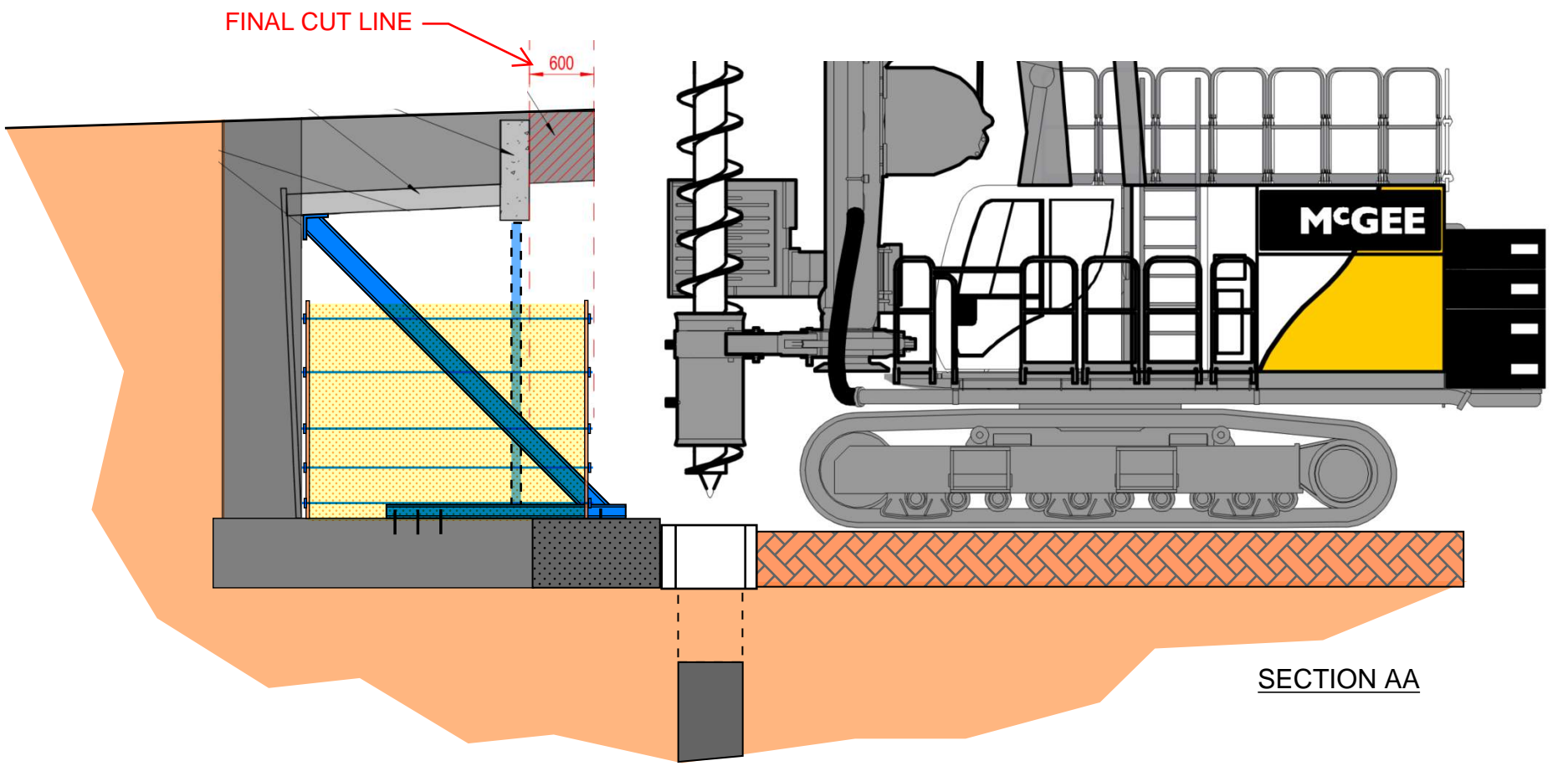
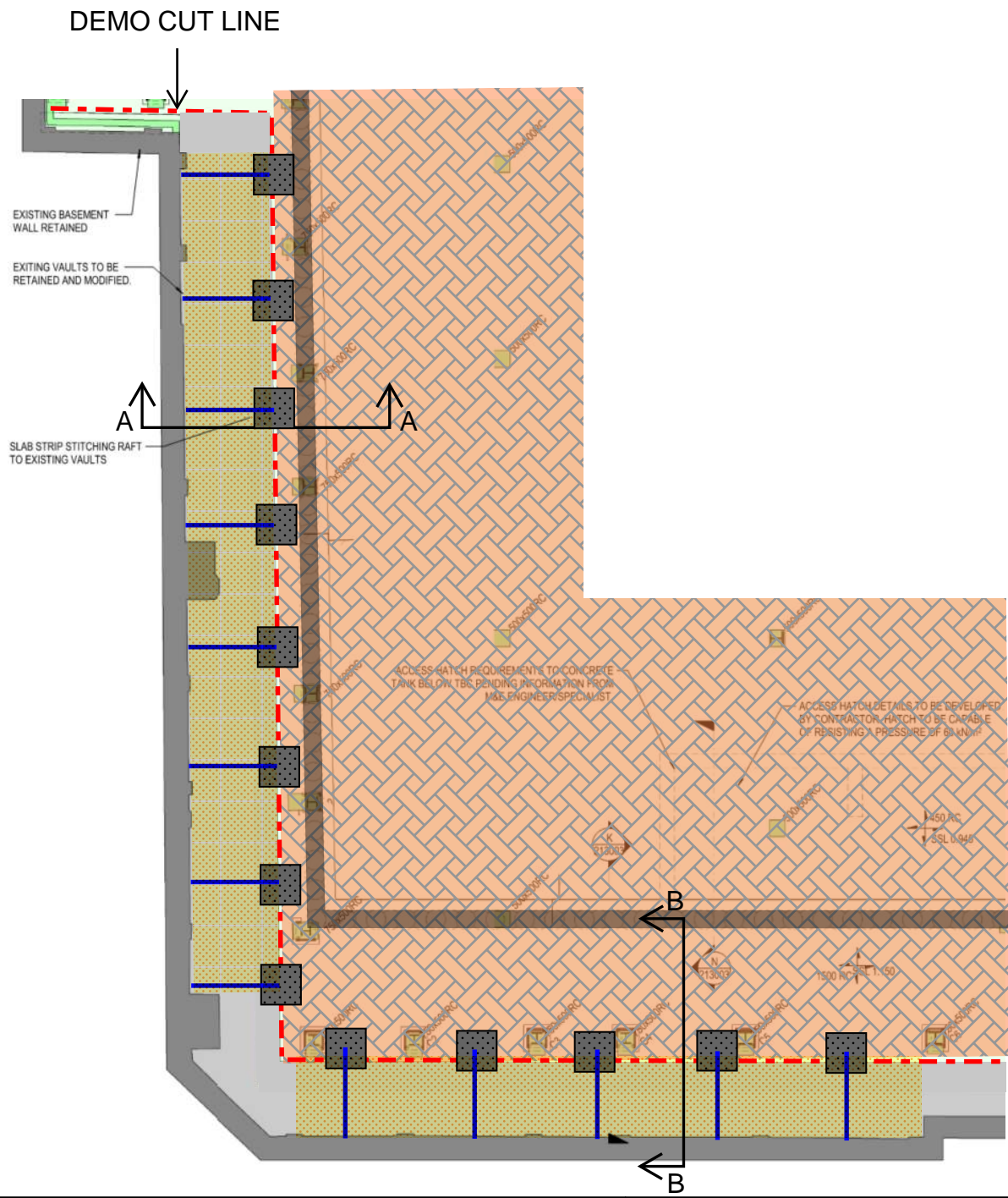

PROJECT TITLE	SKETCH TITLE

SKETCH No.	DRAWN	DATE

SCALE	REV.

McGEE
 A Specialist Engineering Contractor
 McGee Group (Holdings) Ltd
 Level 9 Alto Tower, 5 Hatfields
 London SE1 9PG
 Tel: 020 8998 1101 Fax: 020 8997 7690

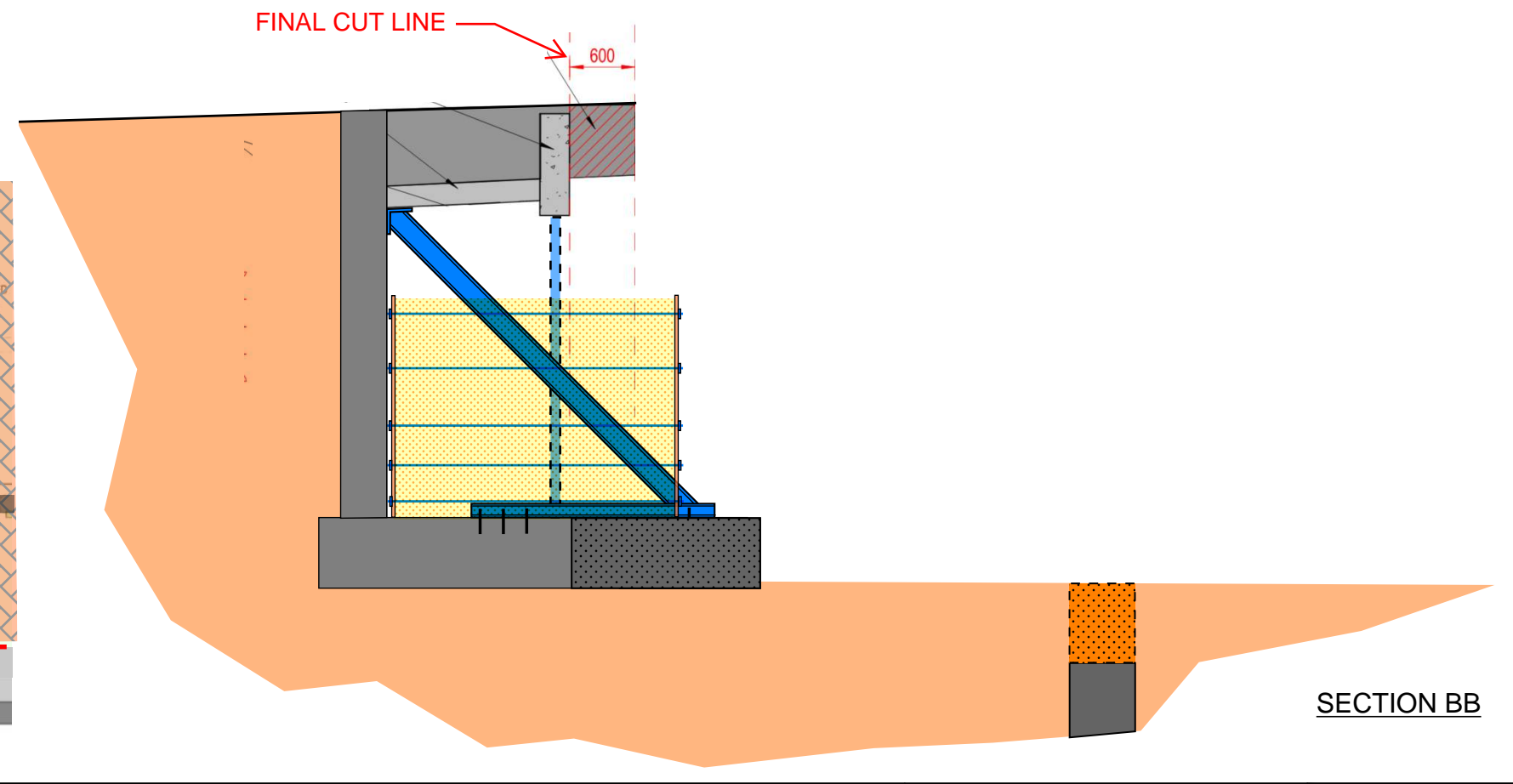
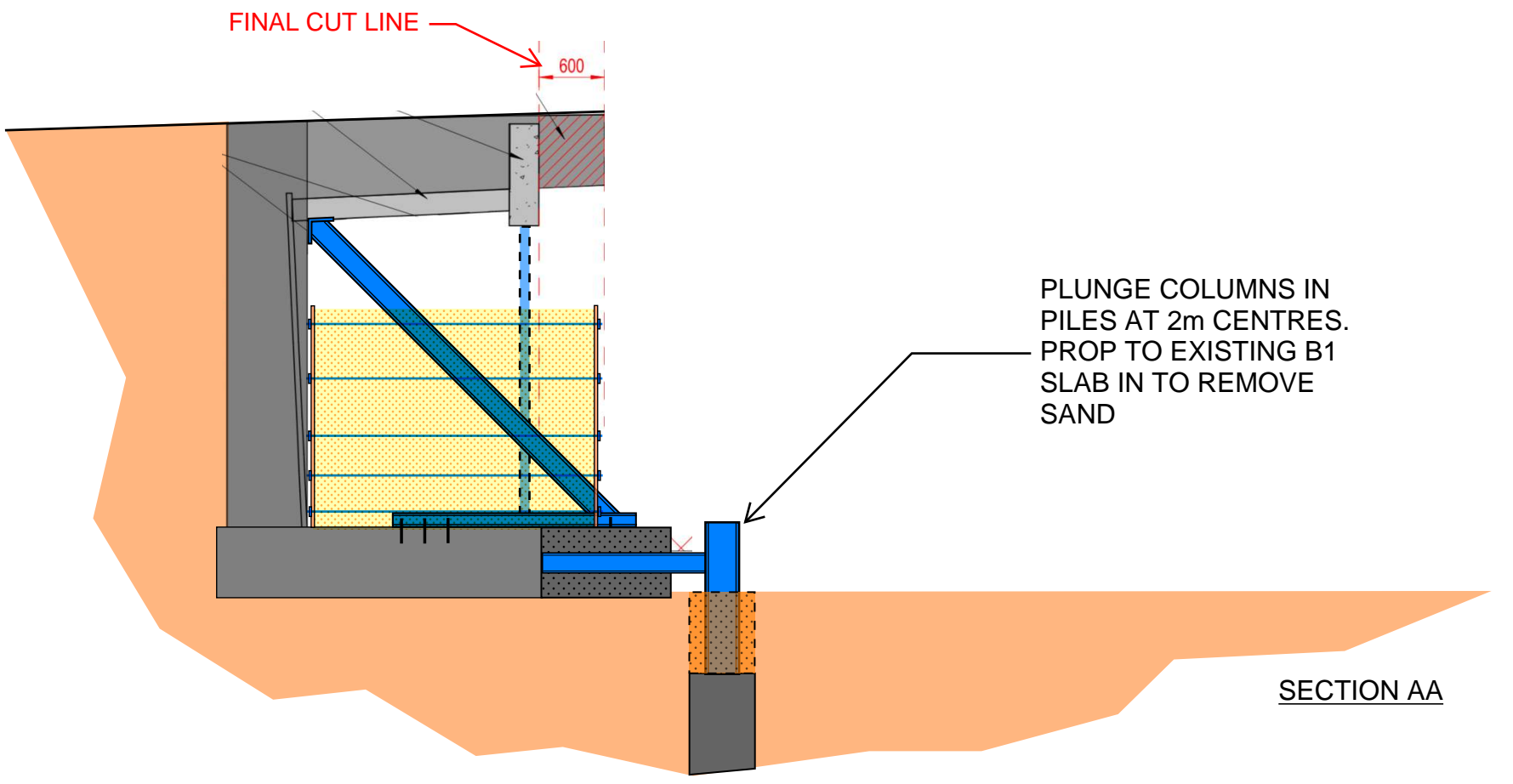
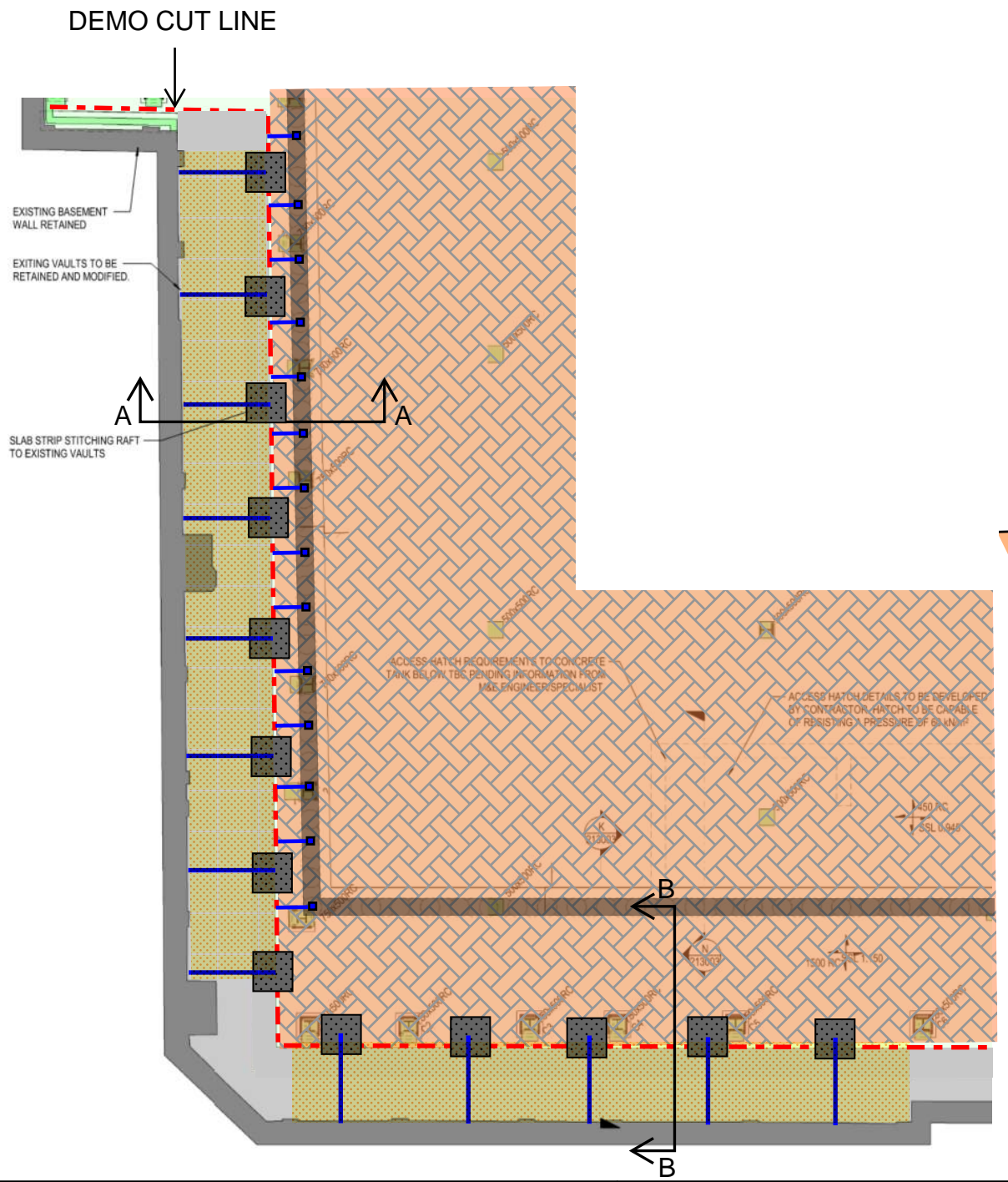

PROJECT TITLE	SKETCH TITLE
---------------	--------------

SKETCH No.	DRAWN	DATE
------------	-------	------

SCALE	REV.
-------	------

McGEE A Specialist Engineering Contractor McGee Group (Holdings) Ltd Level 9 Alto Tower, 5 Hatfields London SE1 9PG Tel: 020 8998 1101 Fax: 020 8997 7690	

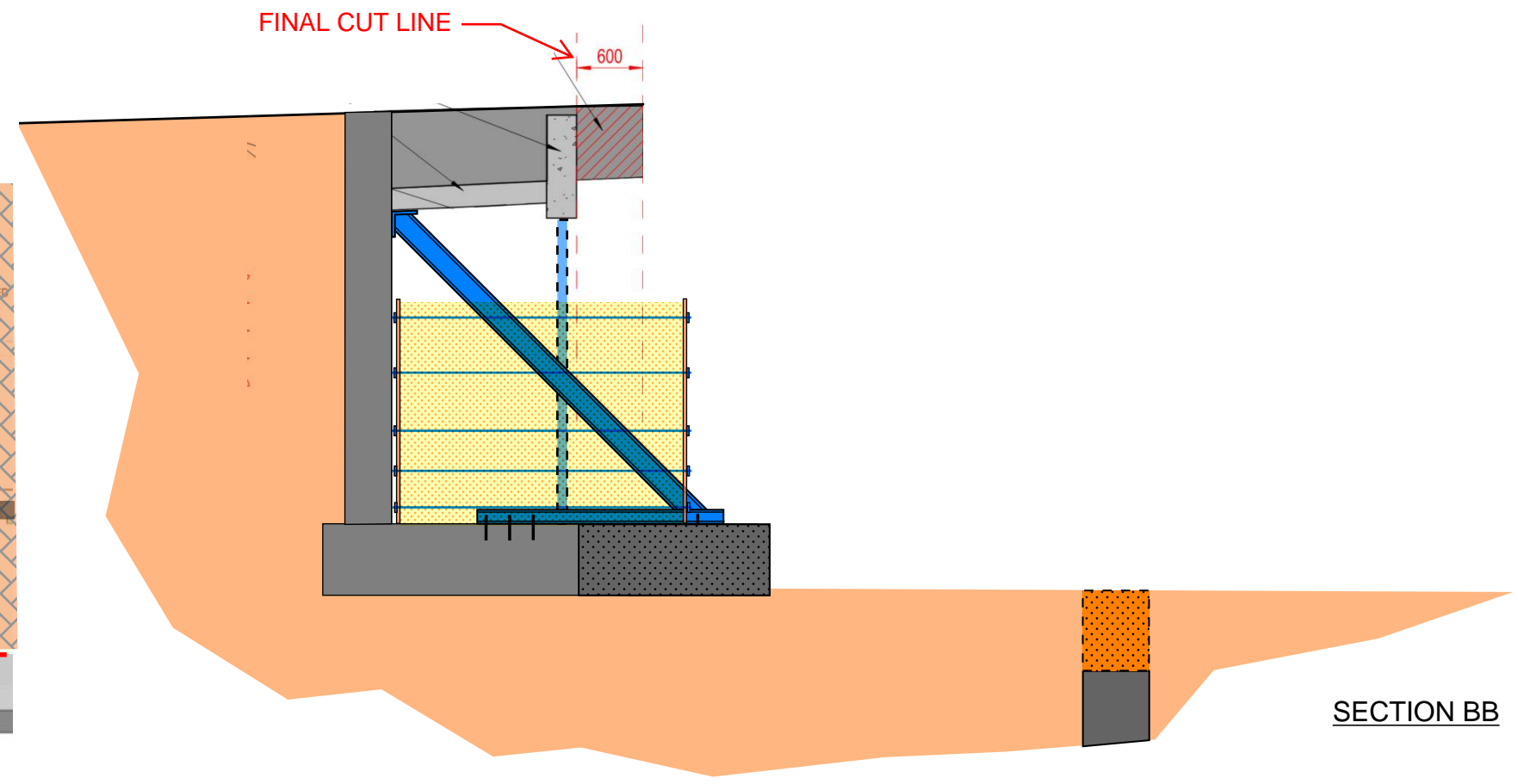
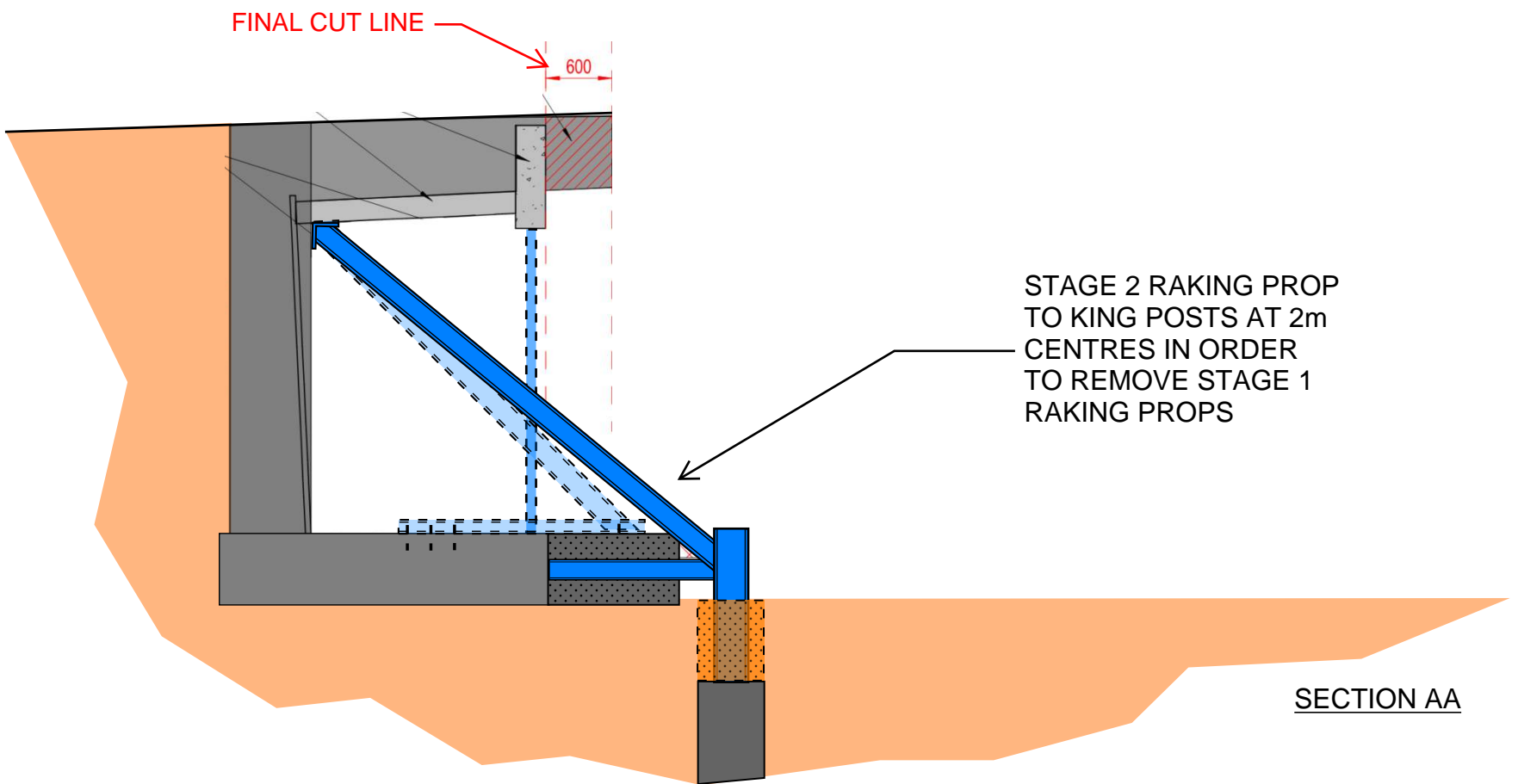
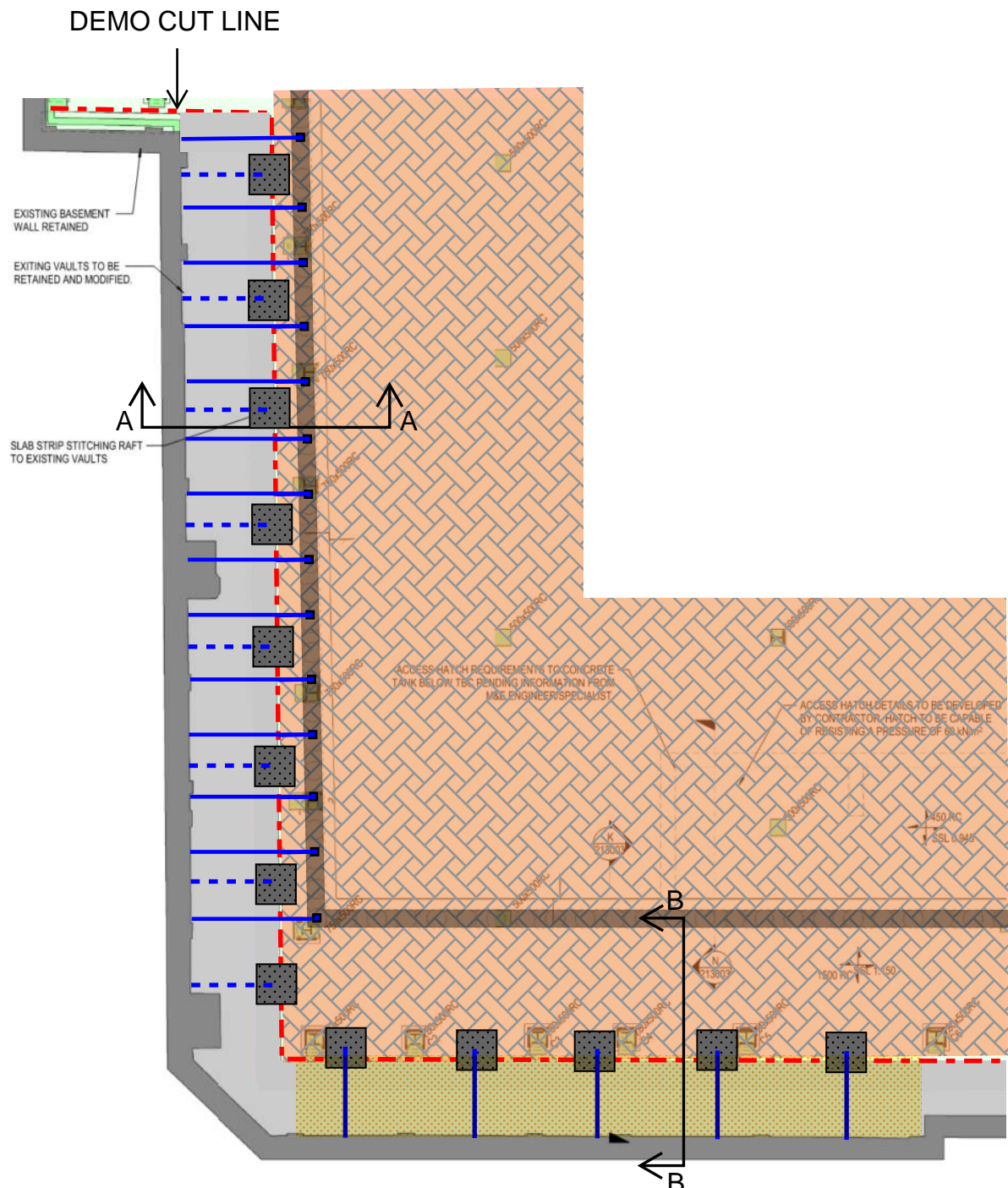

PROJECT TITLE	SKETCH TITLE

SKETCH No.	DRAWN	DATE

SCALE	REV.

McGEE
A Specialist Engineering Contractor

McGee Group (Holdings) Ltd
Level 9 Alto Tower, 5 Hatfields
London SE1 9PG
Tel: 020 8998 1101 Fax: 020 8997 7690

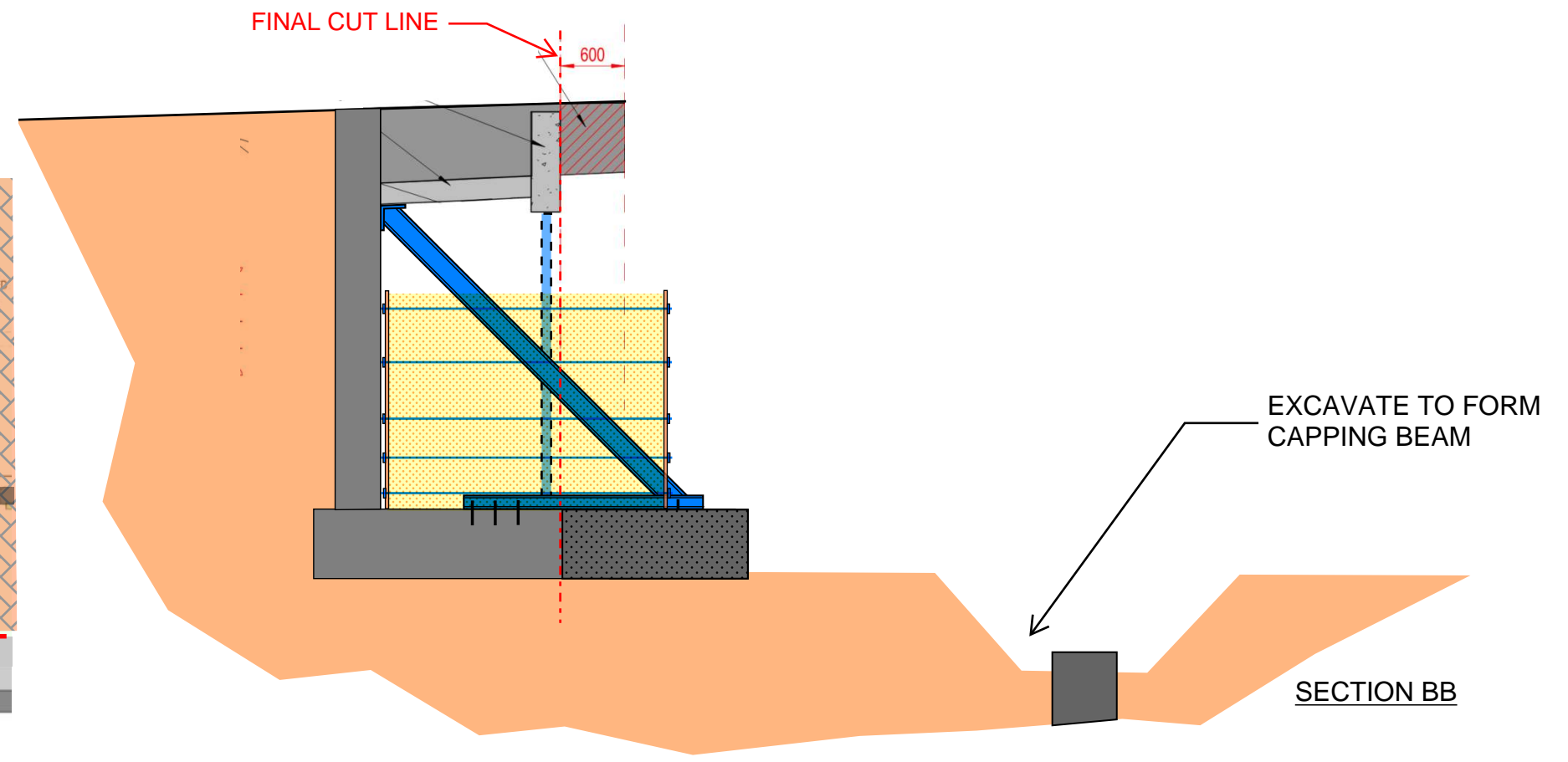
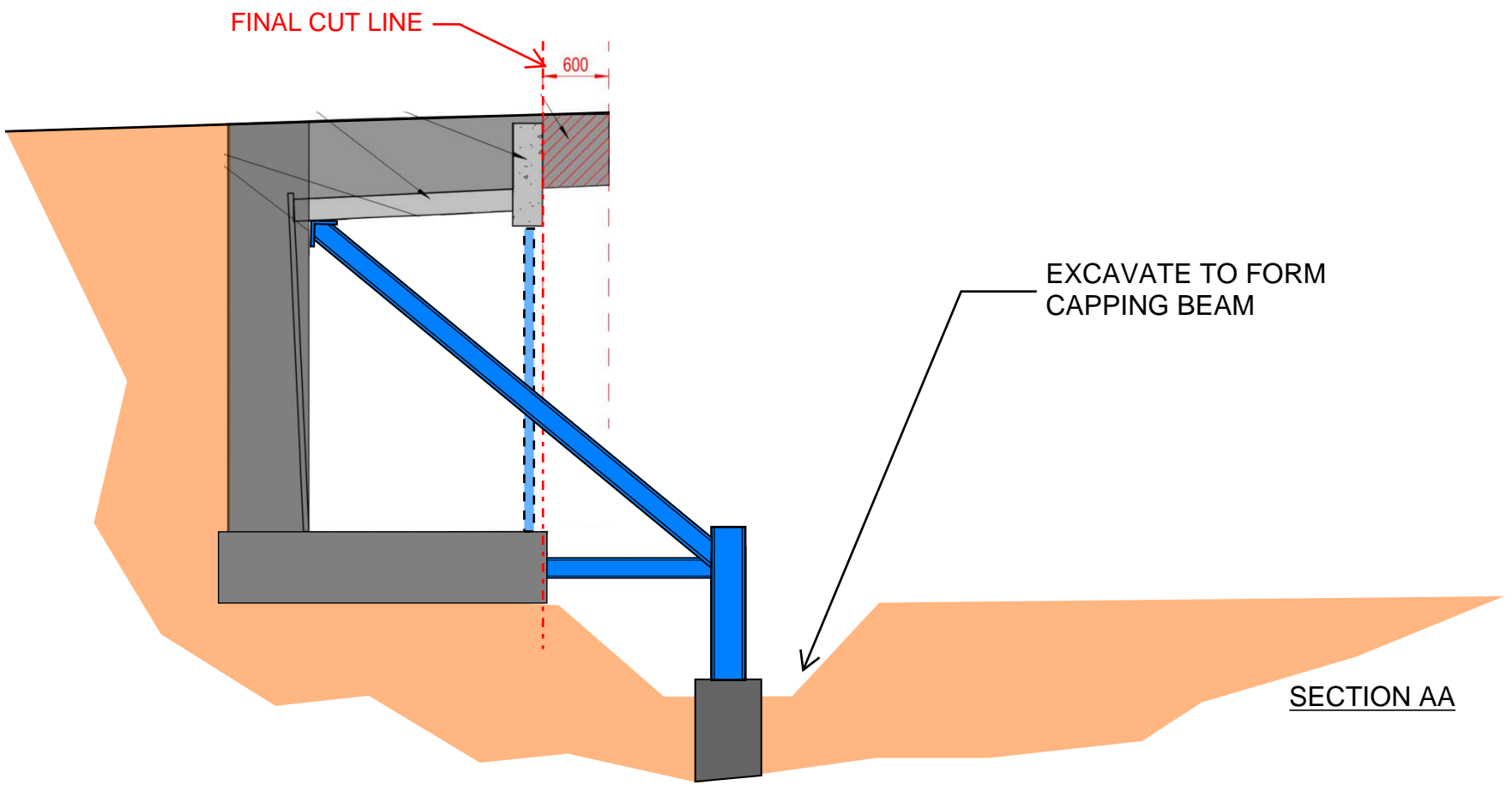
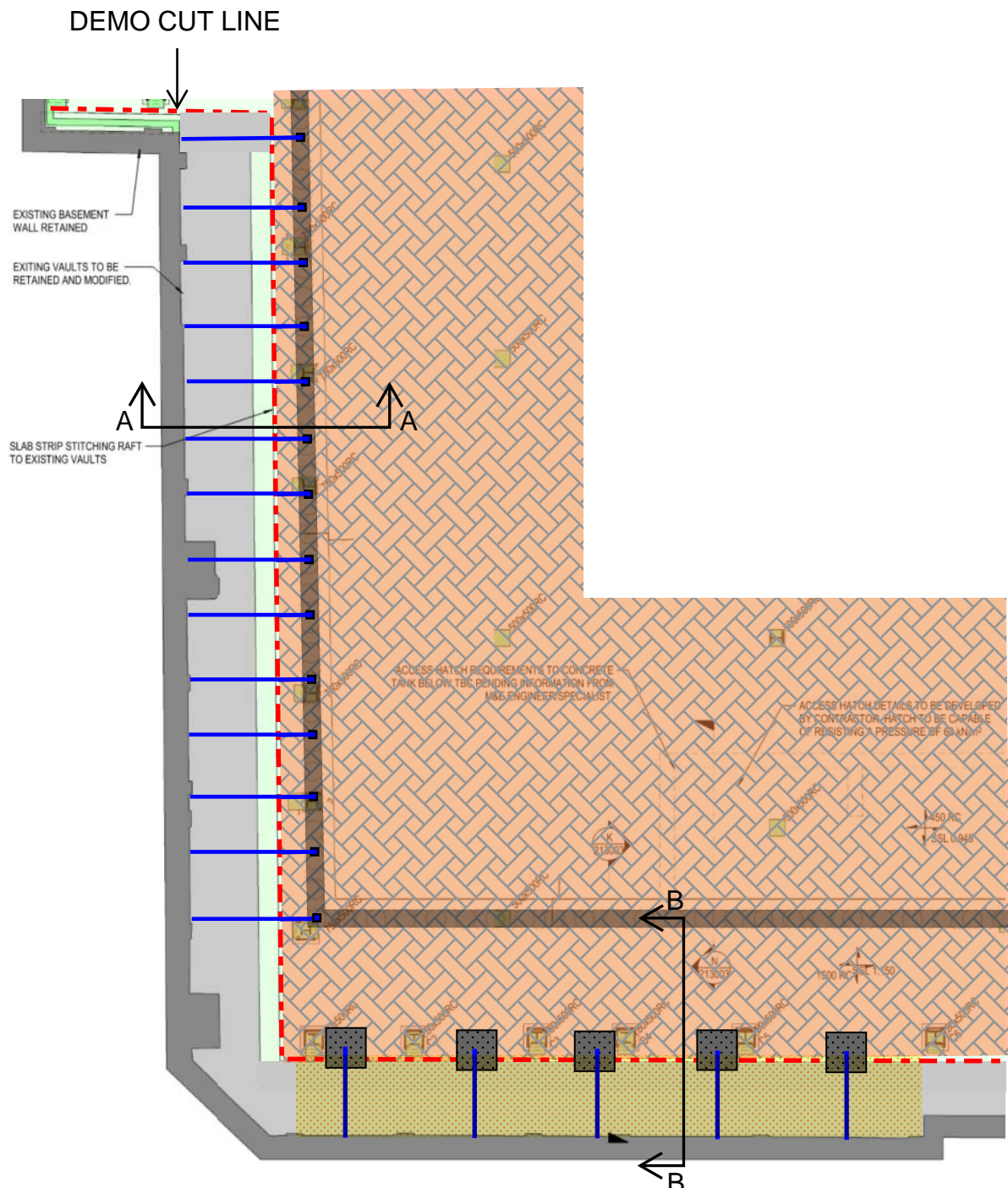

PROJECT TITLE	SKETCH TITLE

SKETCH No.	DRAWN	DATE

SCALE	REV.

McGEE
 A Specialist Engineering Contractor
 McGee Group (Holdings) Ltd
 Level 9 Alto Tower, 5 Hatfields
 London SE1 9PG
 Tel: 020 8998 1101 Fax: 020 8997 7690

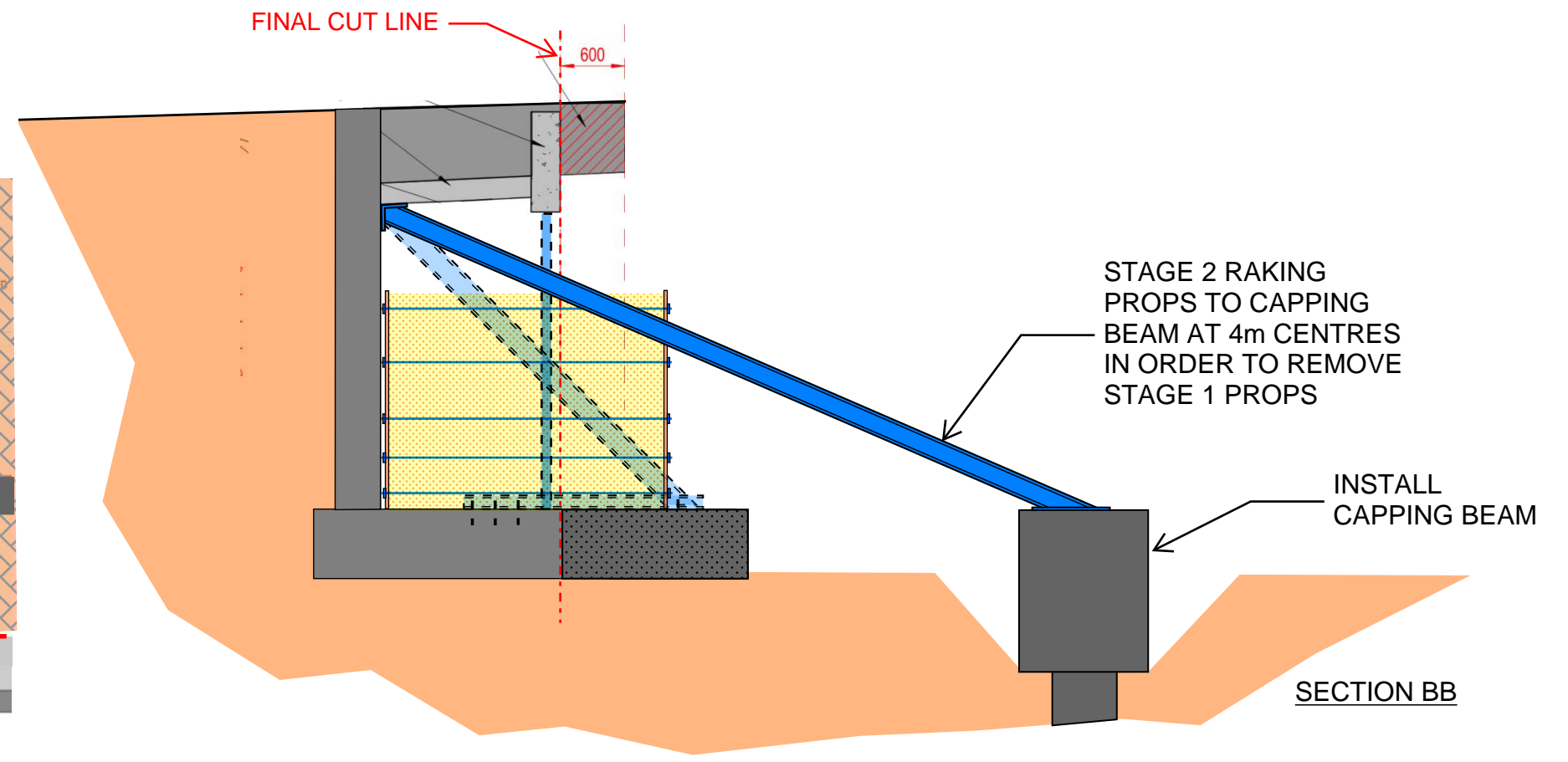
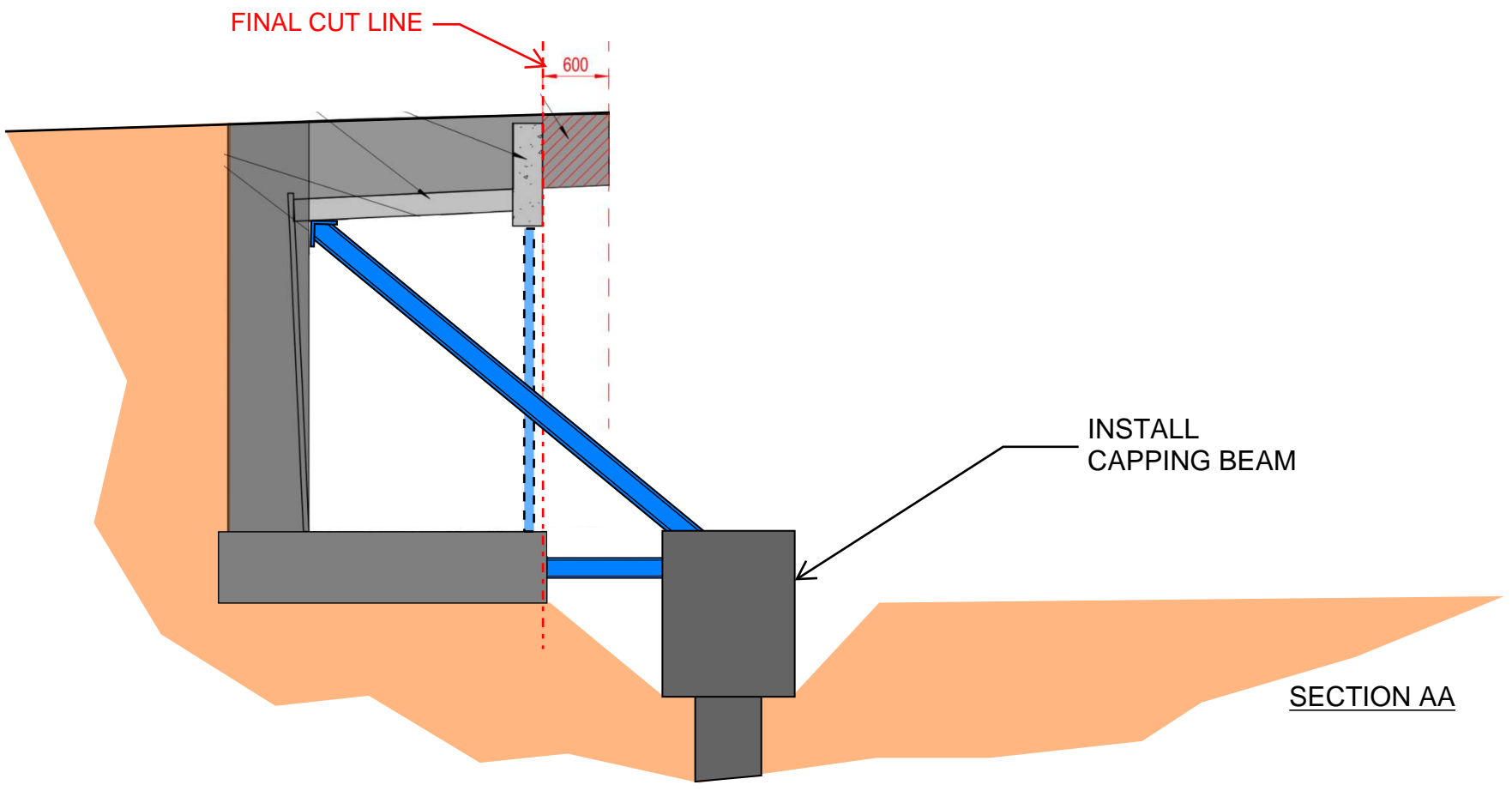
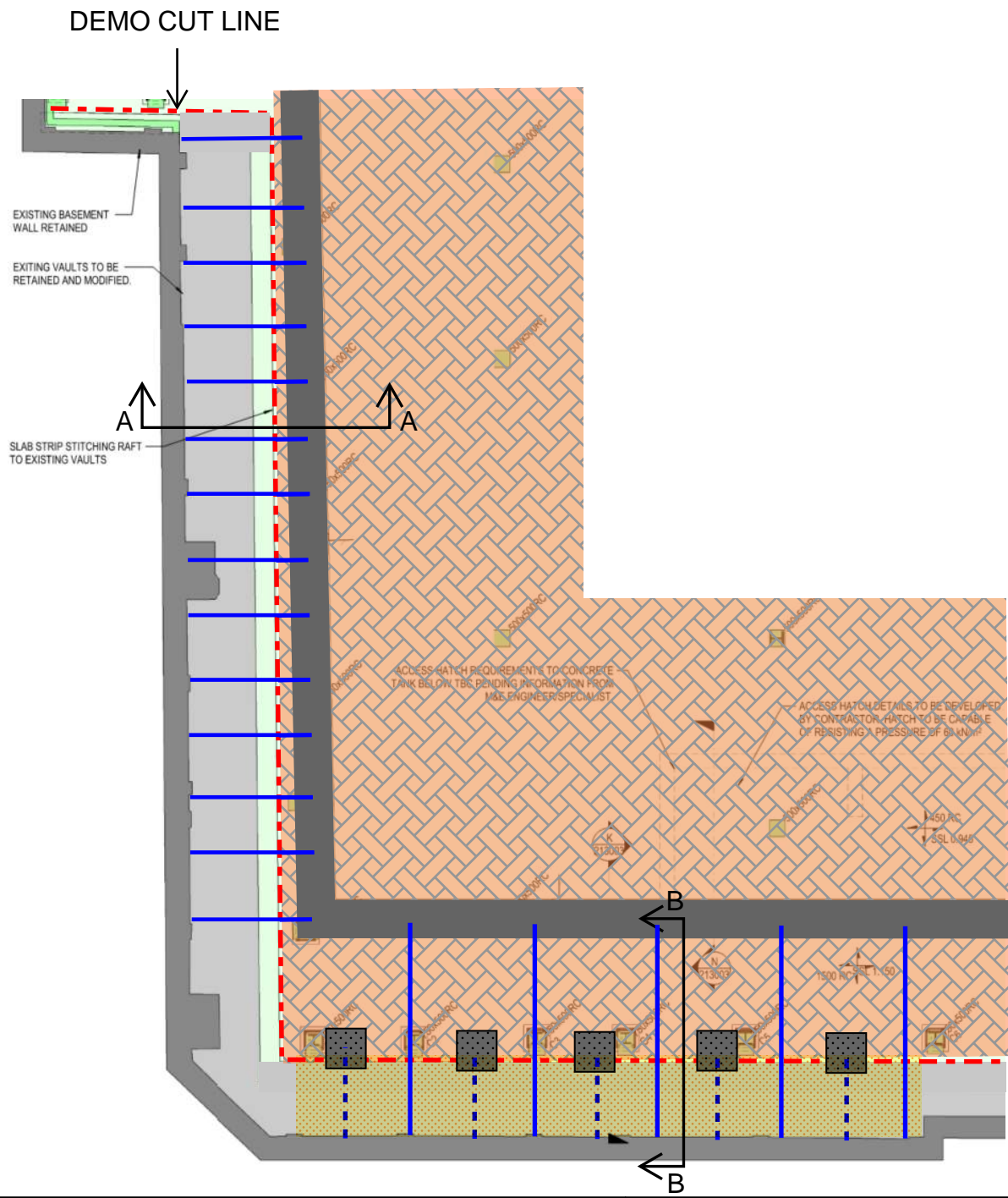

PROJECT TITLE	SKETCH TITLE

SKETCH No.

DRAWN	DATE
SCALE	REV.

McGEE
A Specialist Engineering Contractor

McGee Group (Holdings) Ltd
Level 9 Alto Tower, 5 Hatfields
London SE1 9PG
Tel: 020 8998 1101 Fax: 020 8997 7690

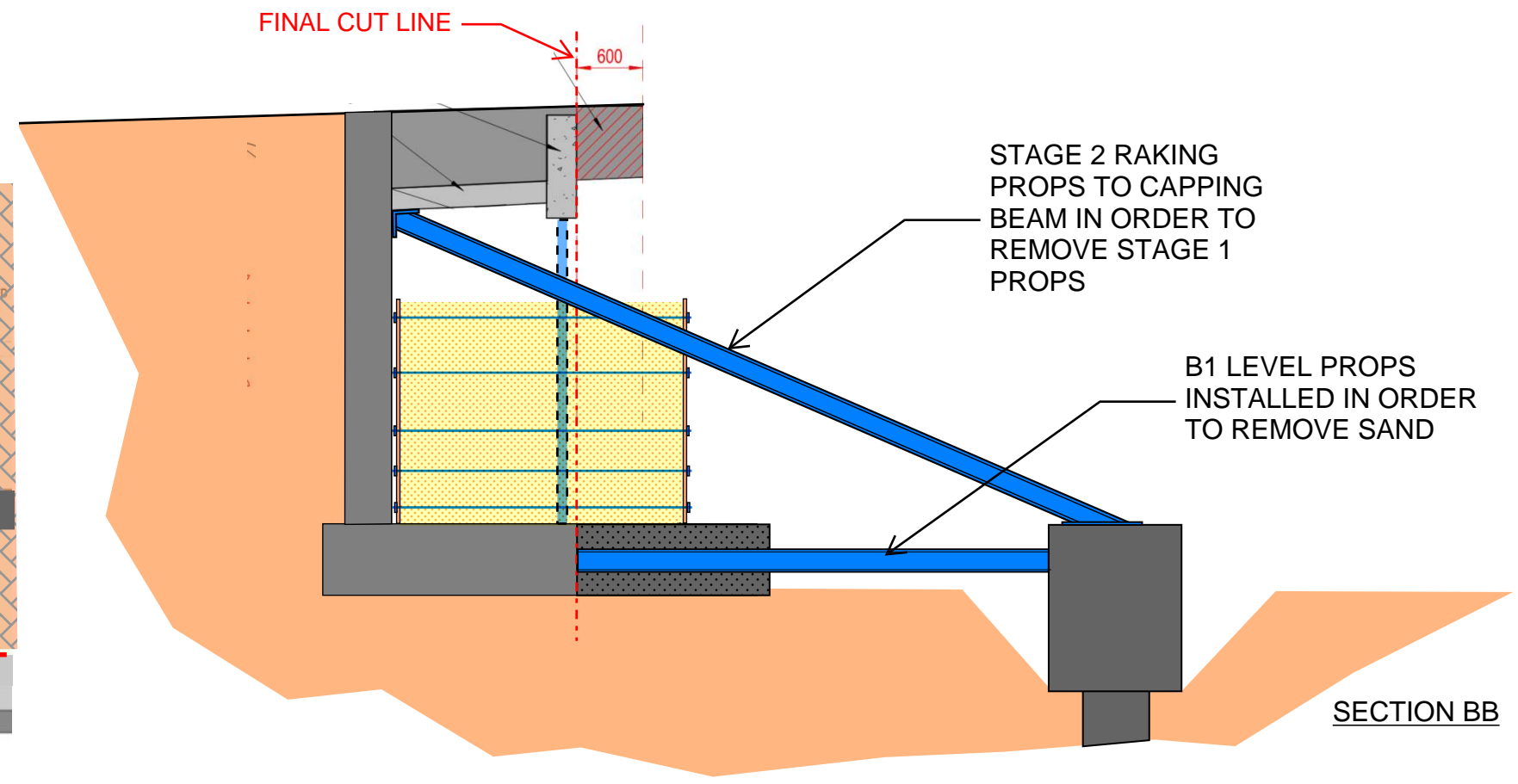
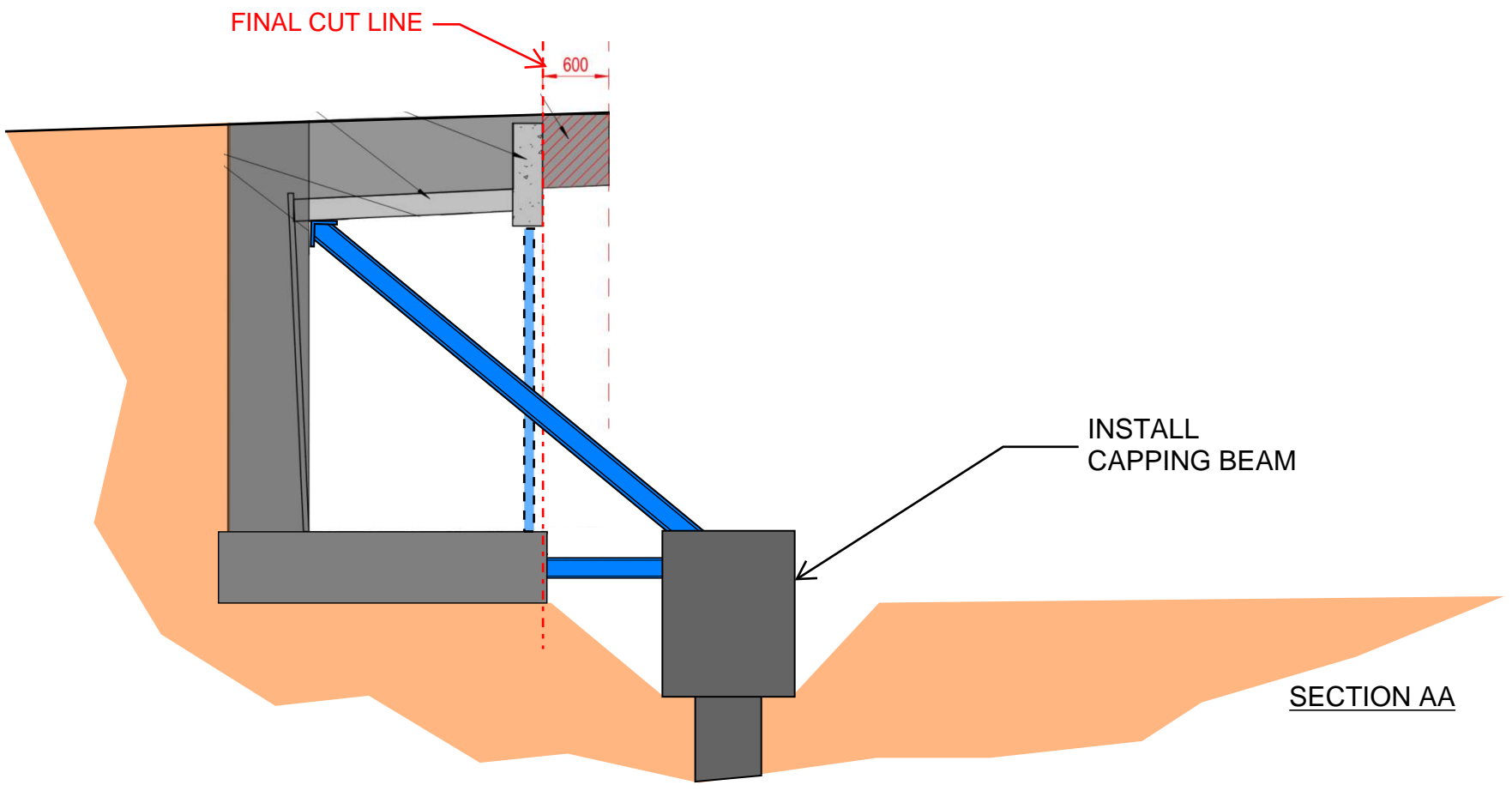
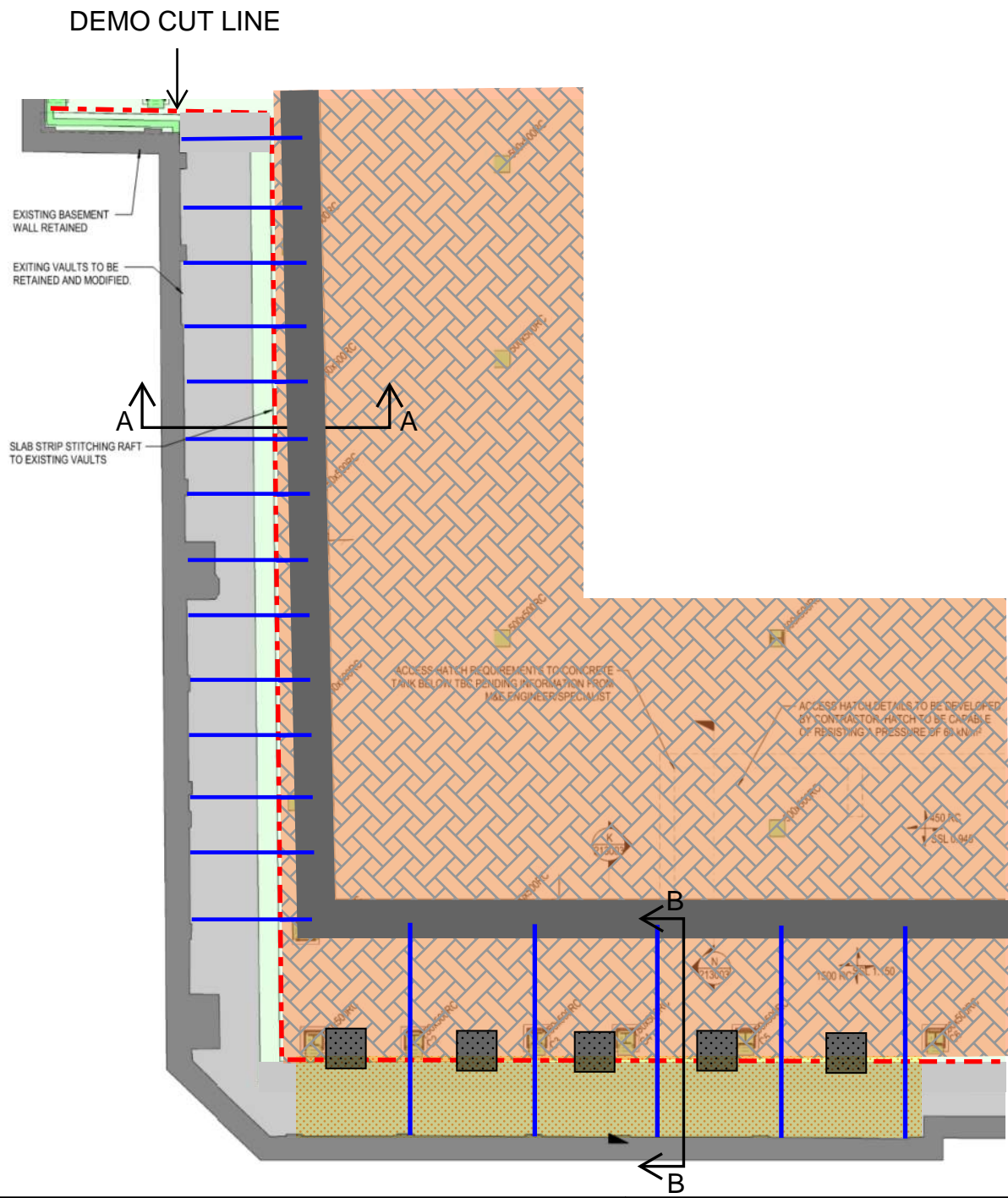

PROJECT TITLE

SKETCH TITLE

SKETCH No.

DRAWN

DATE

SCALE

REV.

McGEE
 A Specialist Engineering Contractor
 McGee Group (Holdings) Ltd
 Level 9 Alto Tower, 5 Hatfields
 London SE1 9PG
 Tel: 020 8998 1101 Fax: 020 8997 7690

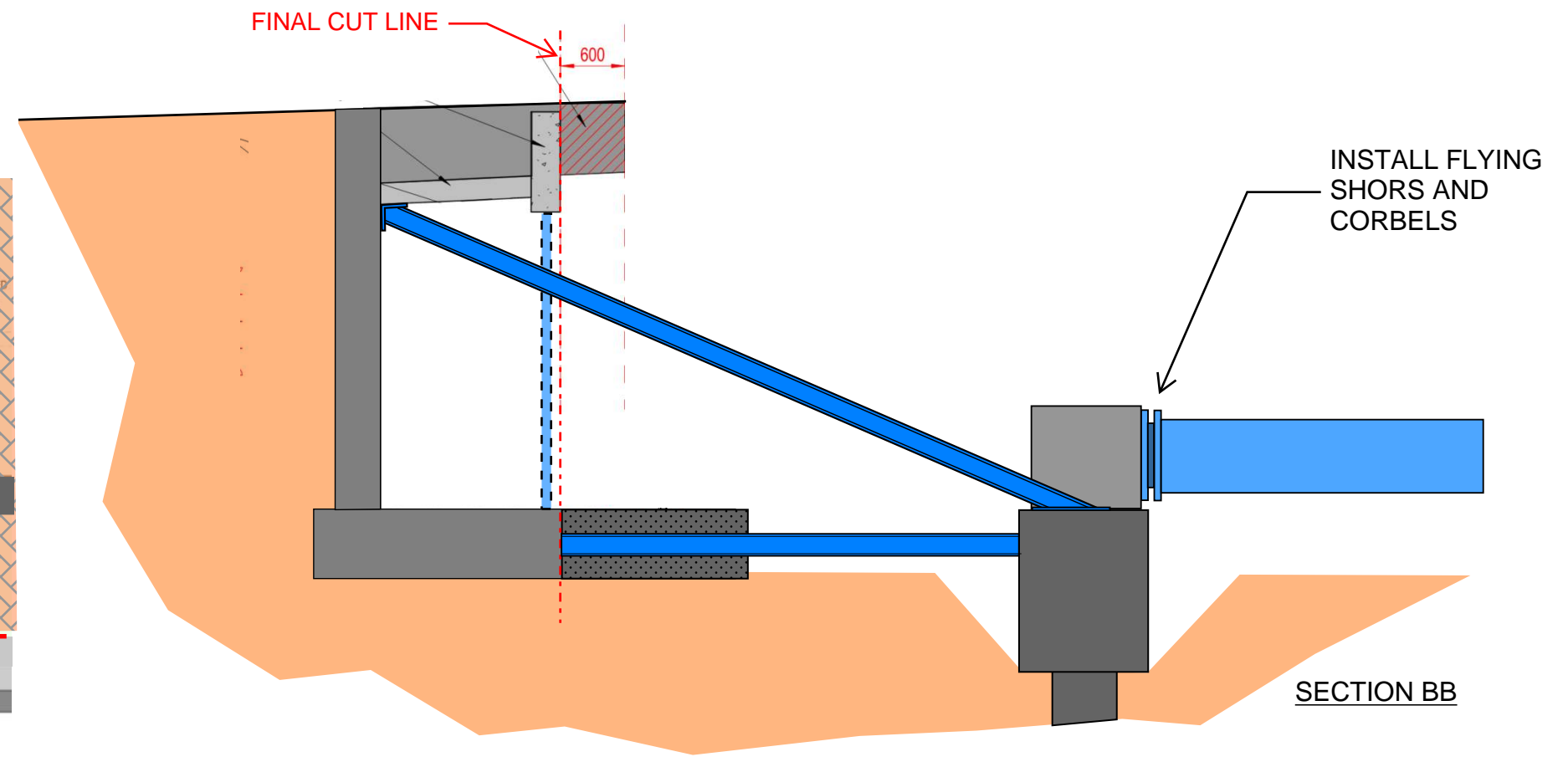
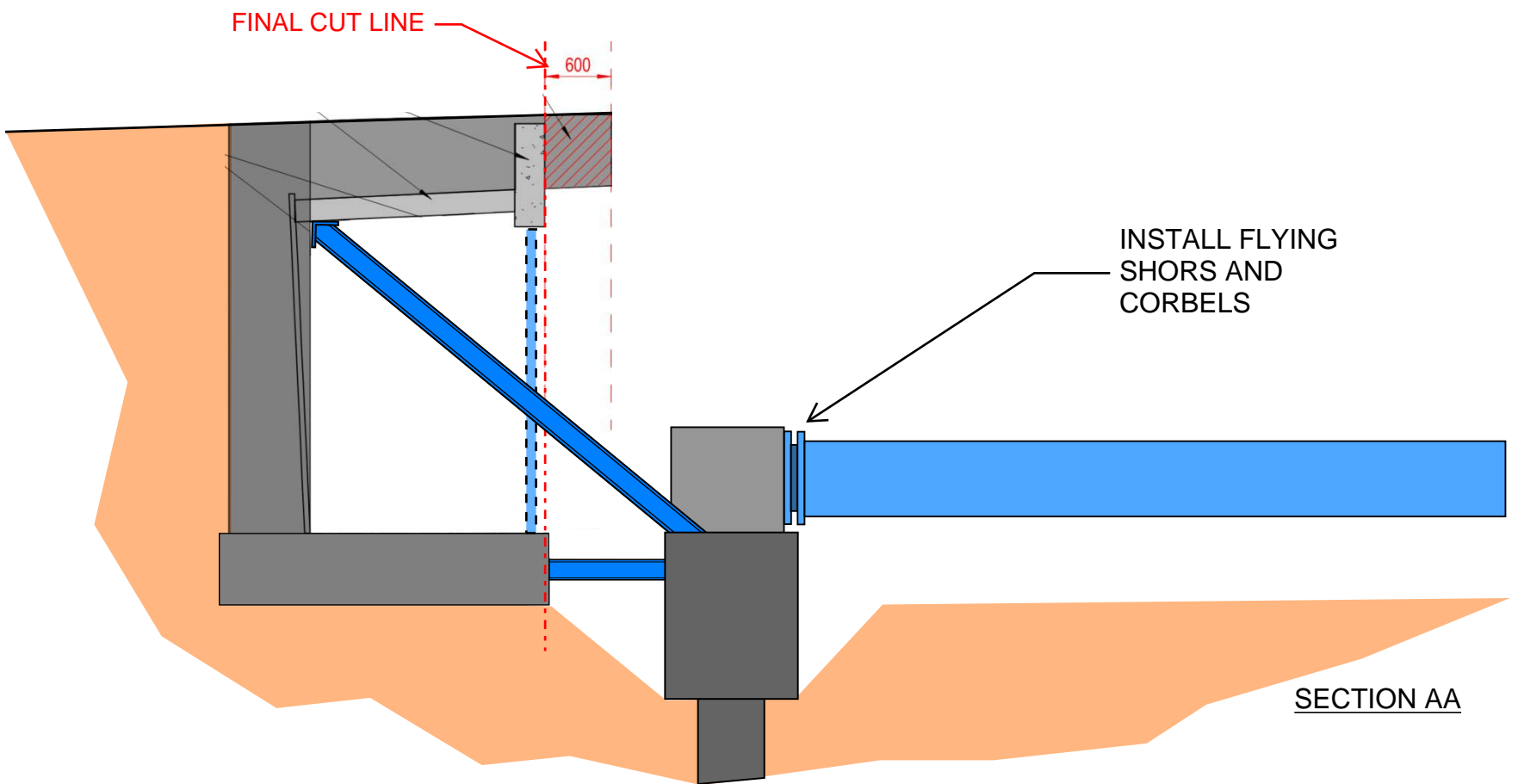
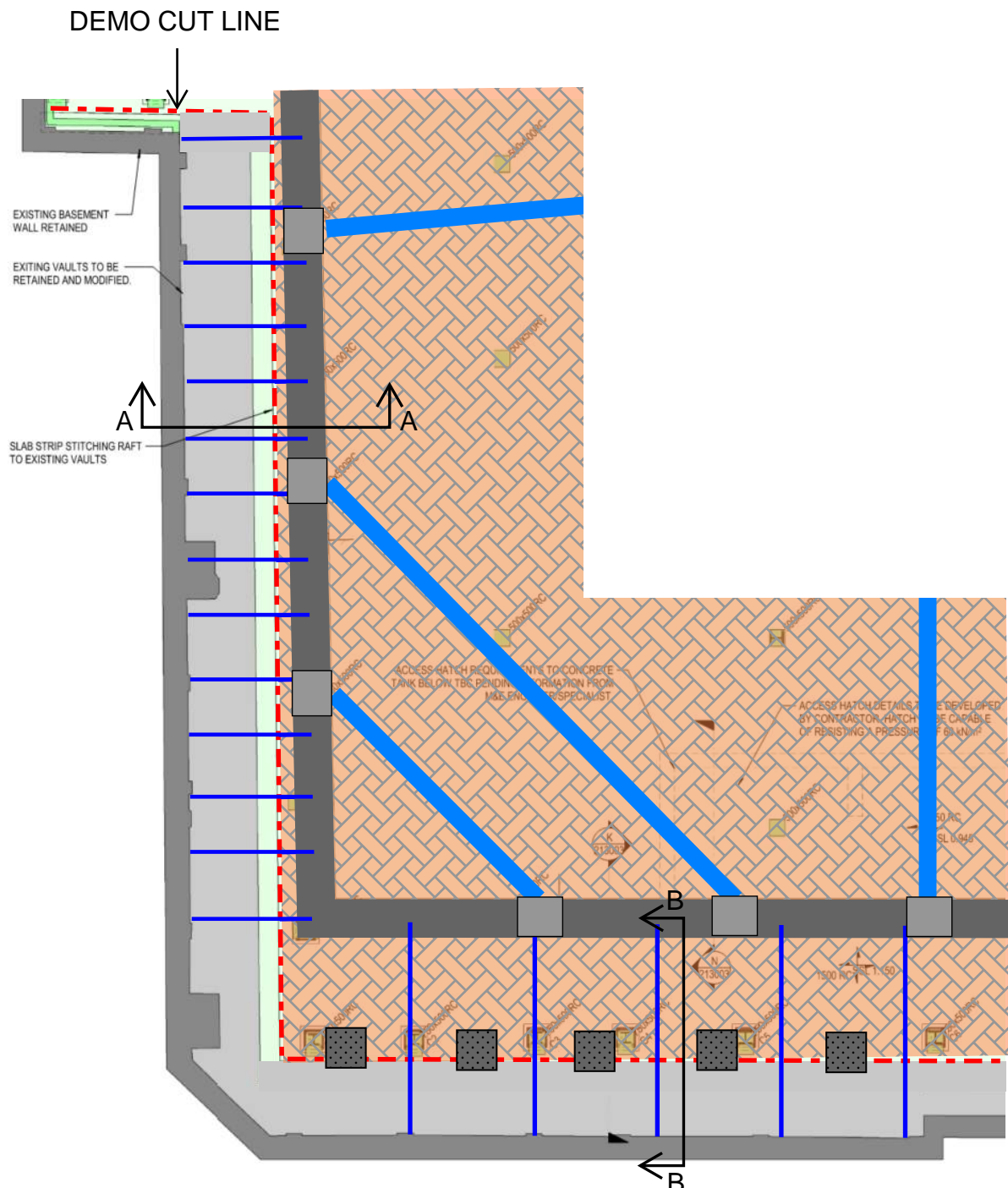

PROJECT TITLE	SKETCH TITLE	SKETCH No.	DRAWN	DATE
			SCALE	REV.



McGEE
A Specialist Engineering Contractor
McGee Group (Holdings) Ltd
Level 9 Alto Tower, 5 Hatfields
London SE1 9PG
Tel: 020 8998 1101 Fax: 020 8997 7690

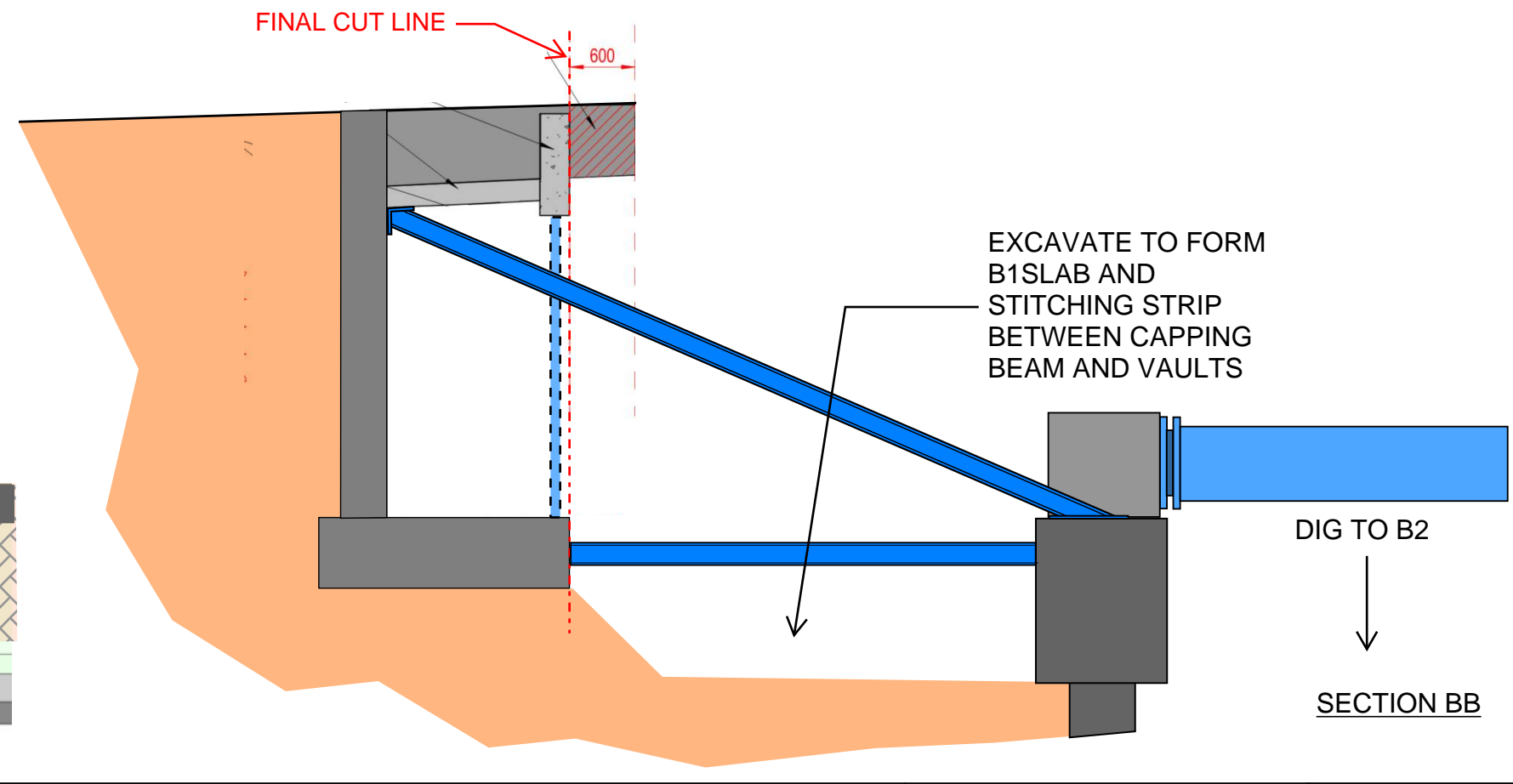
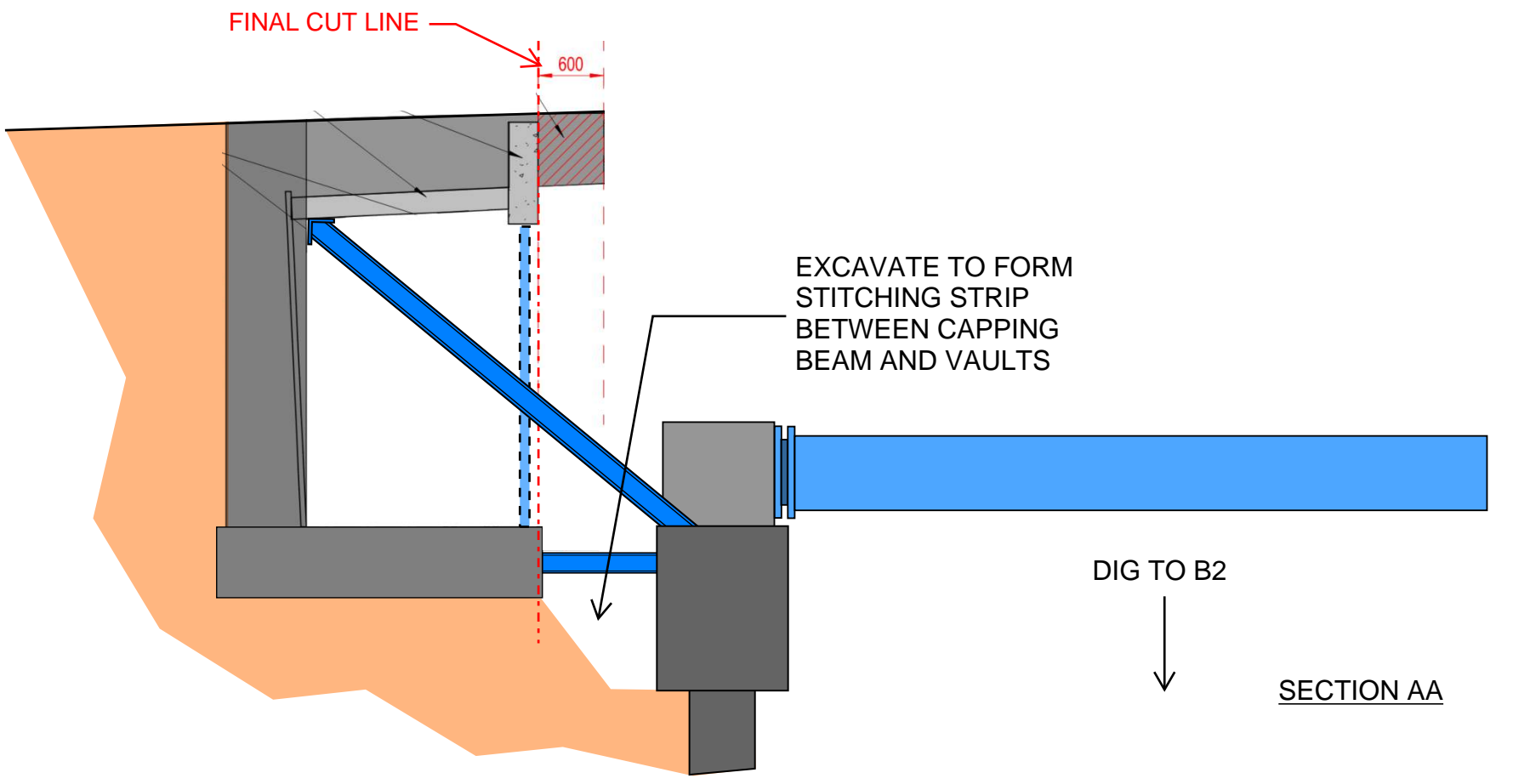
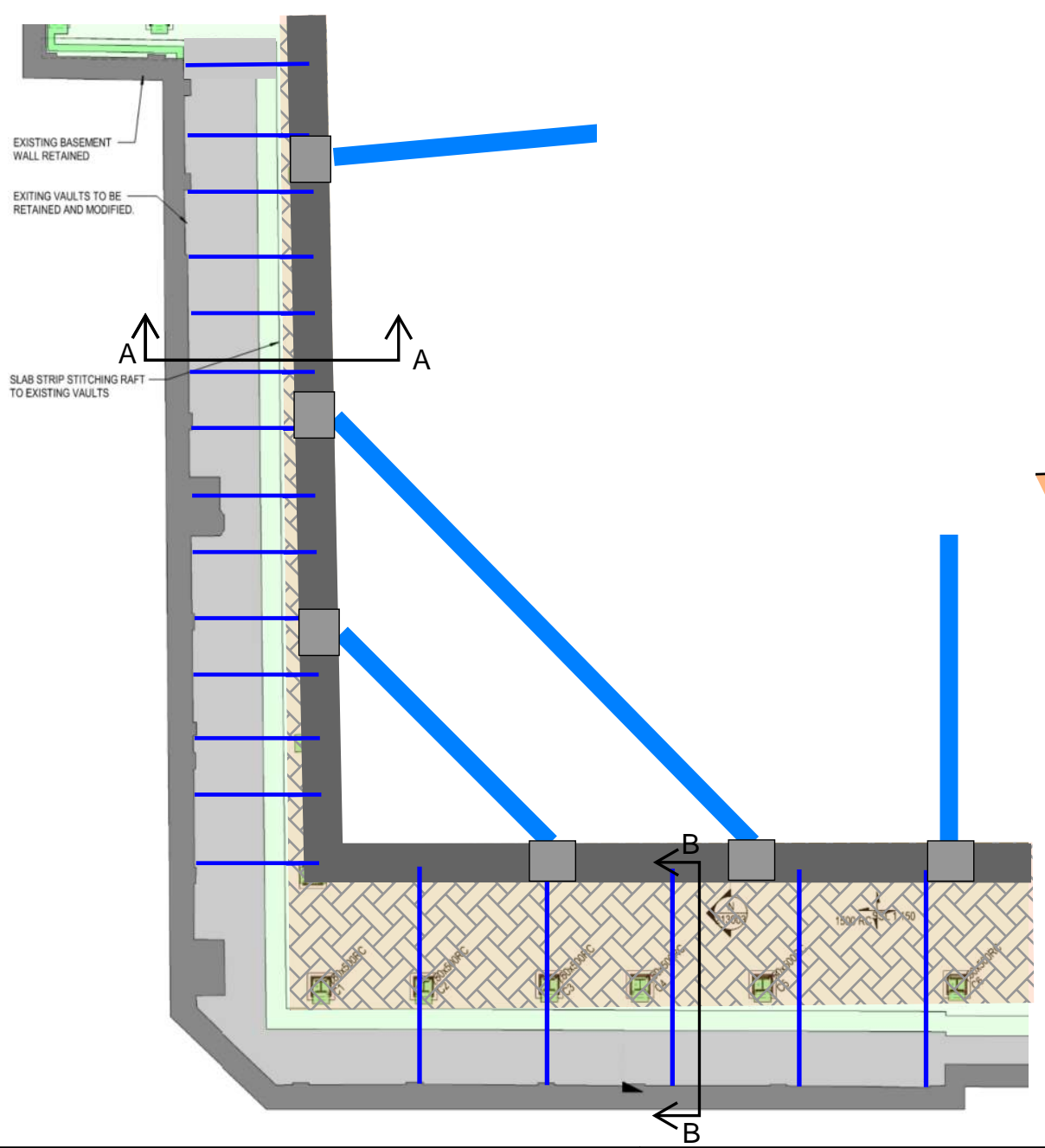

PROJECT TITLE	SKETCH TITLE

SKETCH No.	DRAWN	DATE

SCALE	REV.

McGEE
A Specialist Engineering Contractor

McGee Group (Holdings) Ltd
Level 9 Alto Tower, 5 Hatfields
London SE1 9PG
Tel: 020 8998 1101 Fax: 020 8997 7690

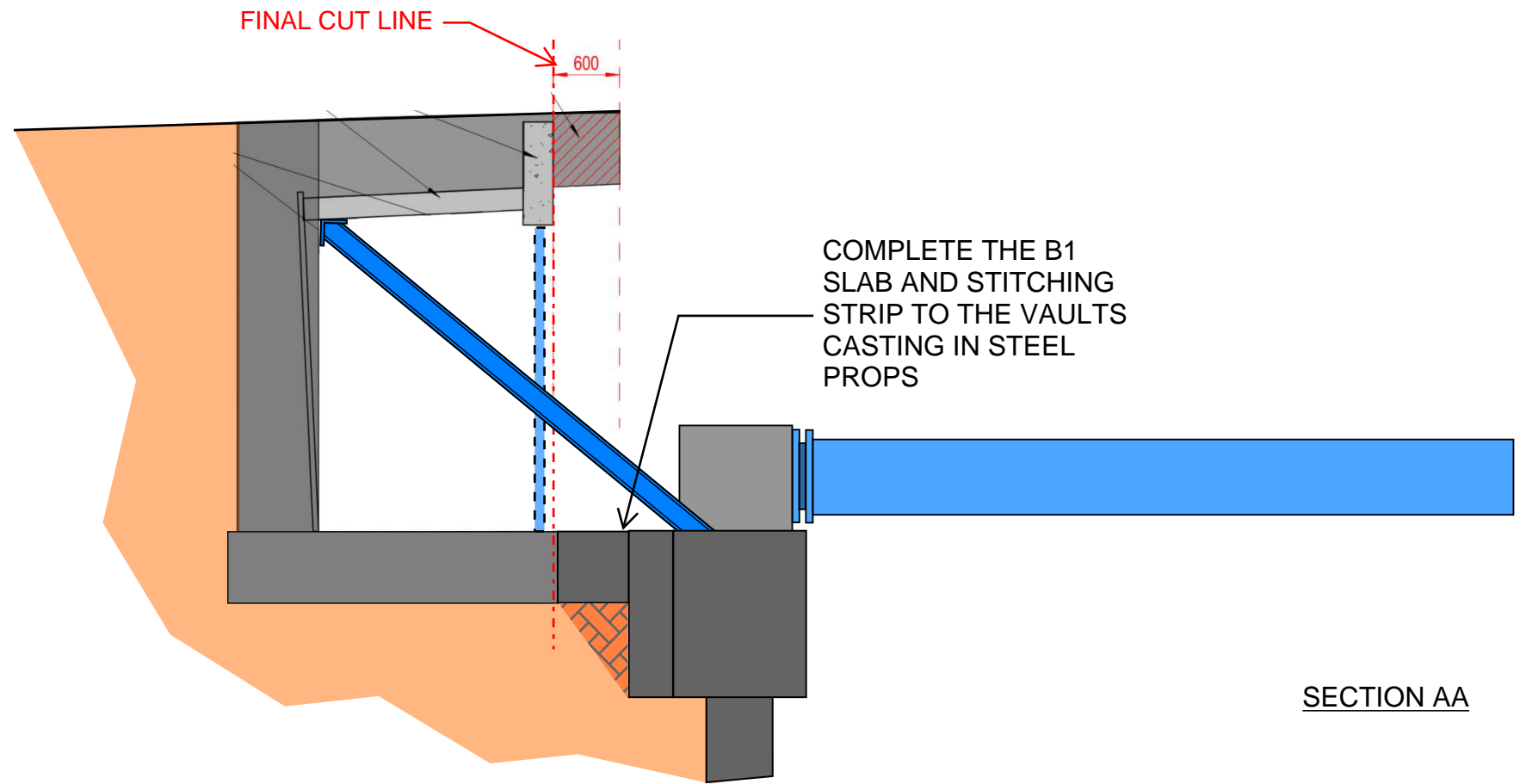
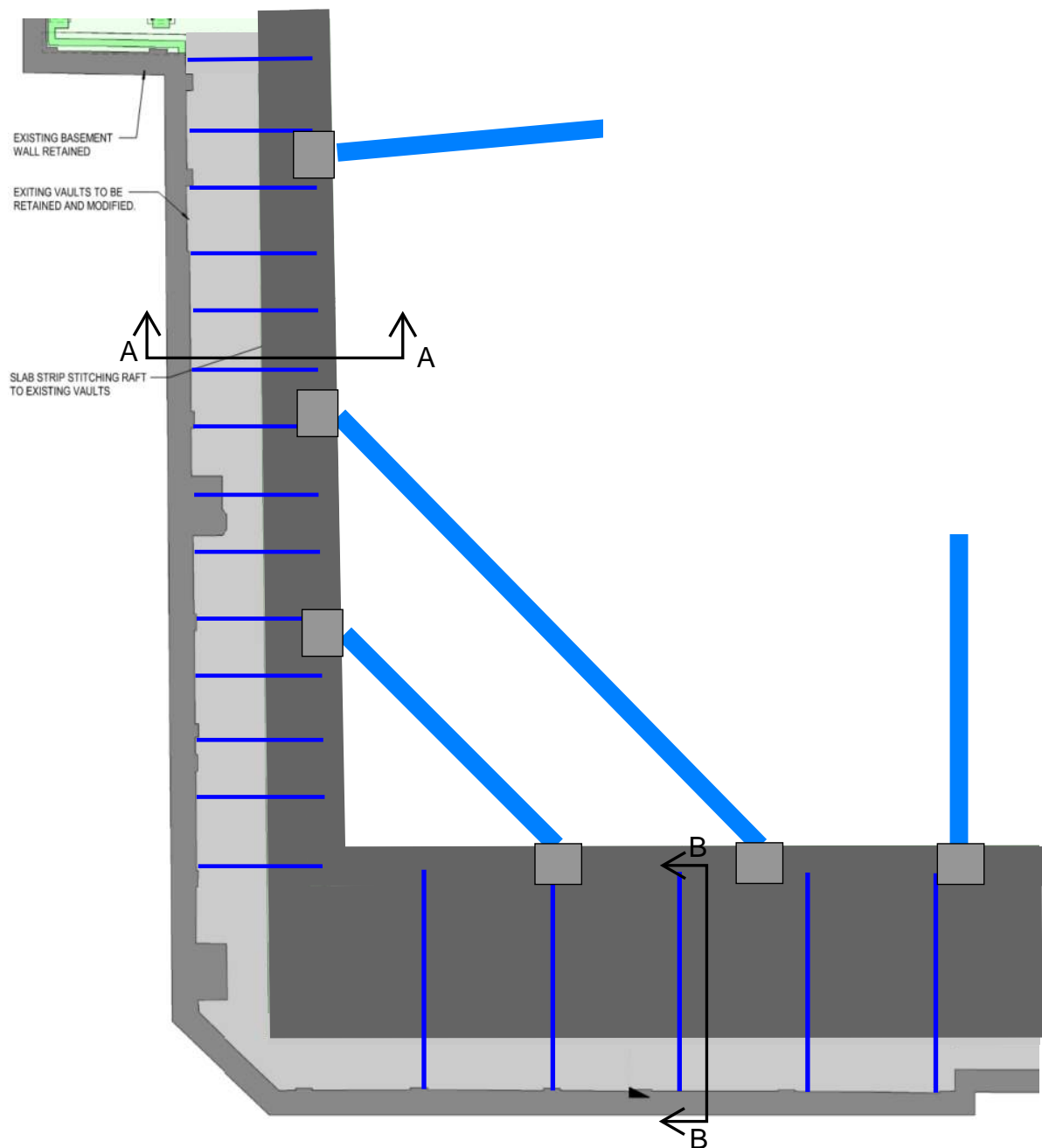

SECTION AA

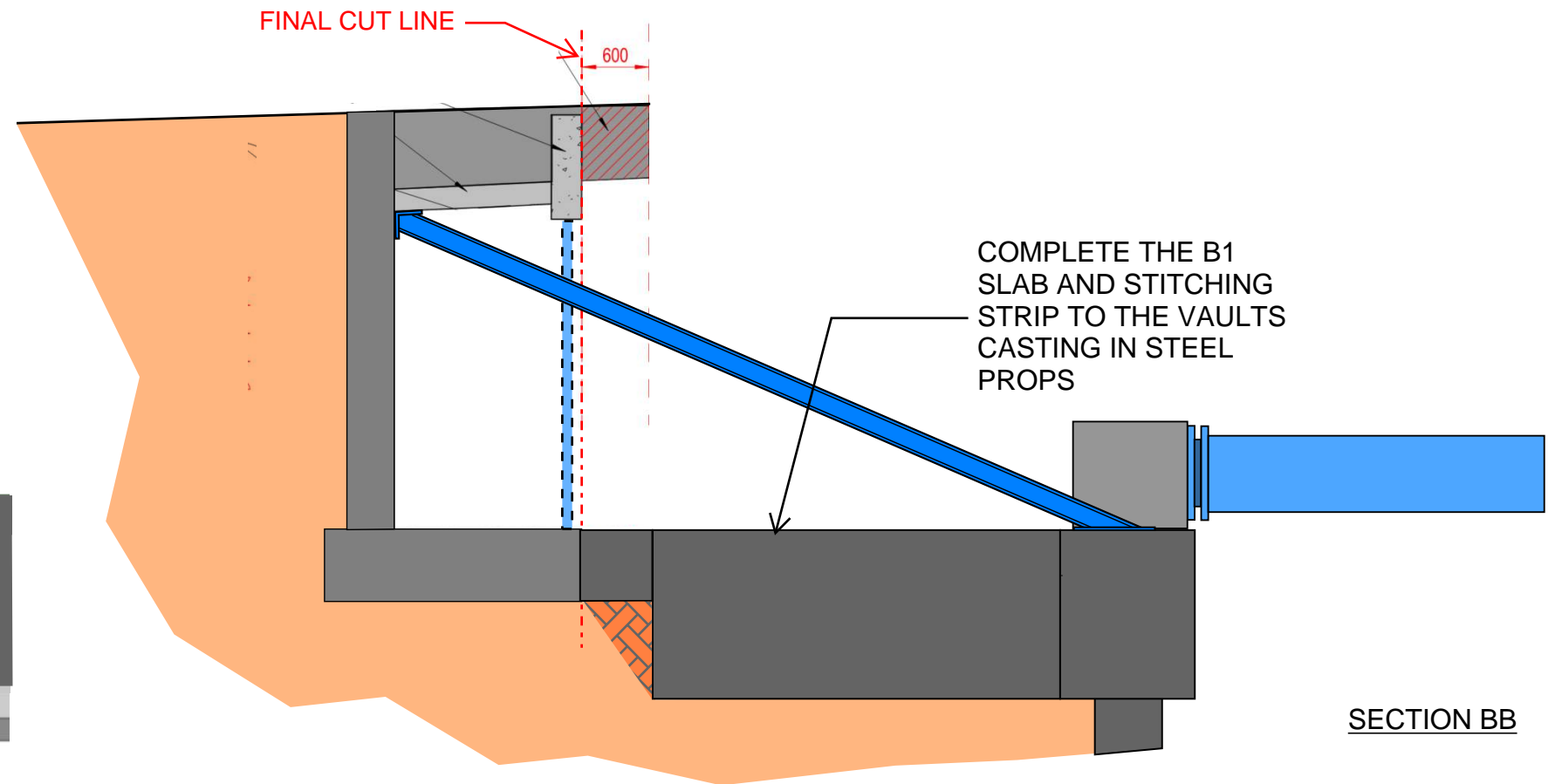

SECTION BB

PROJECT TITLE	SKETCH TITLE

SKETCH No.

DRAWN	DATE
SCALE	REV.

McGEE
 A Specialist Engineering Contractor
 McGee Group (Holdings) Ltd
 Level 9 Alto Tower, 5 Hatfields
 London SE1 9PG
 Tel: 020 8998 1101 Fax: 020 8997 7690

BASEMENT TENDER BASEMENT VAULTS - EAST

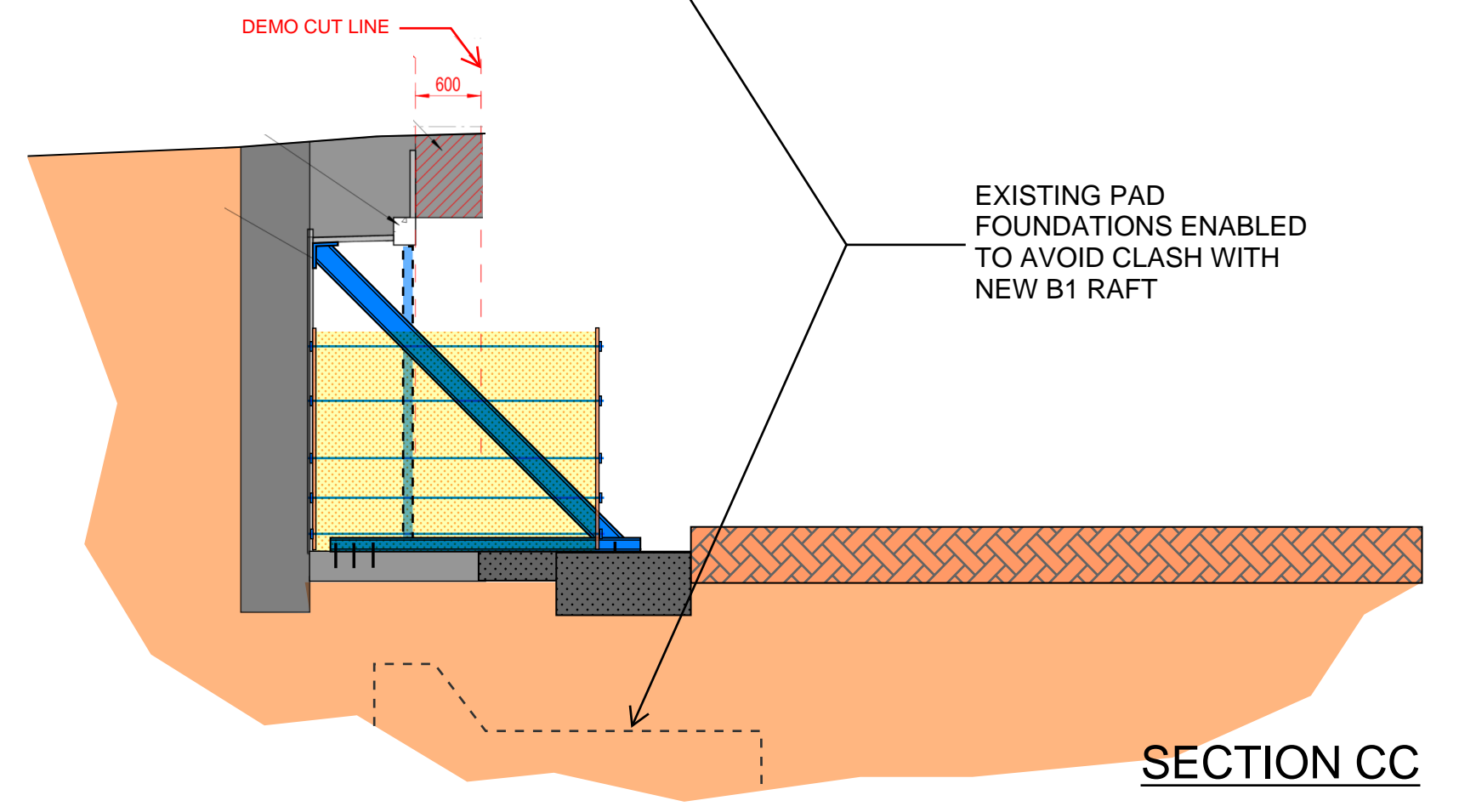
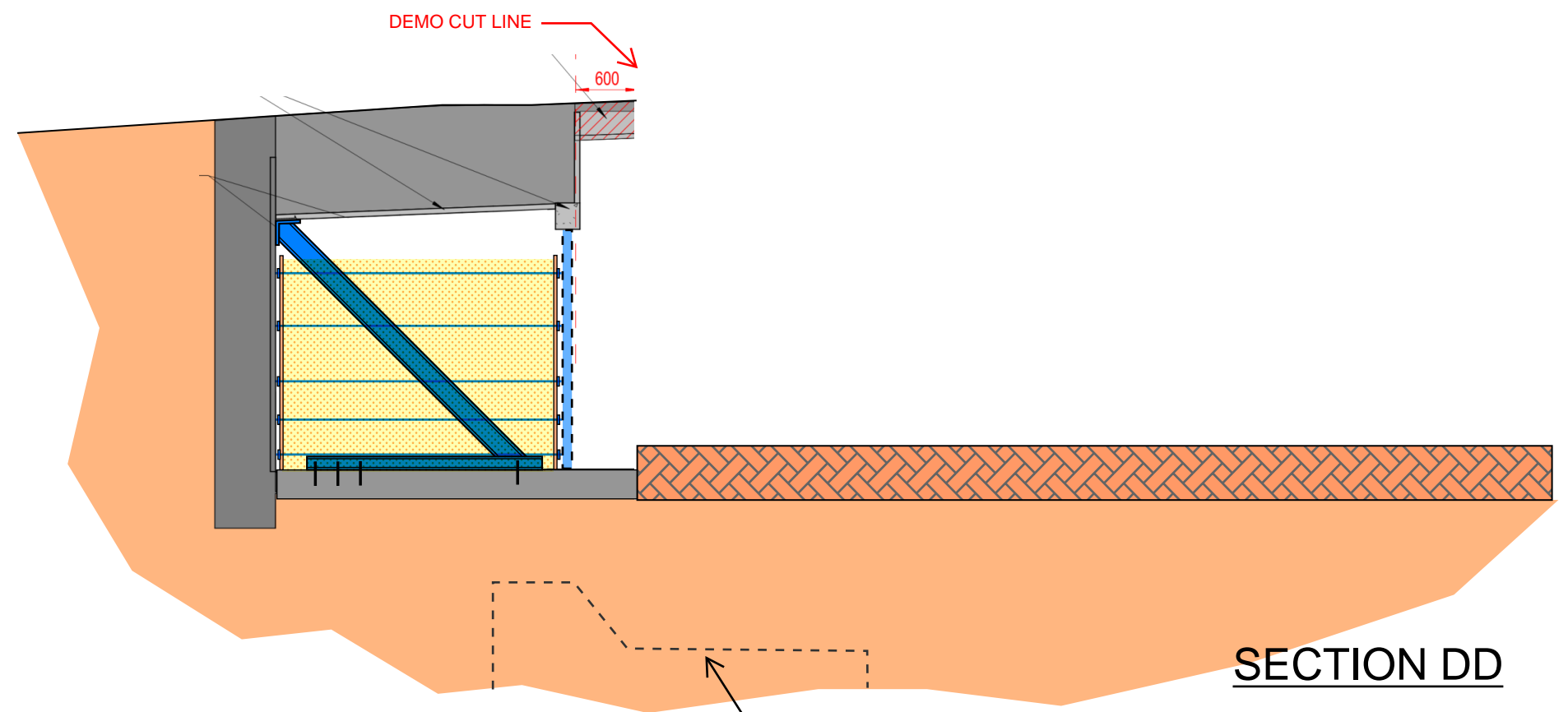
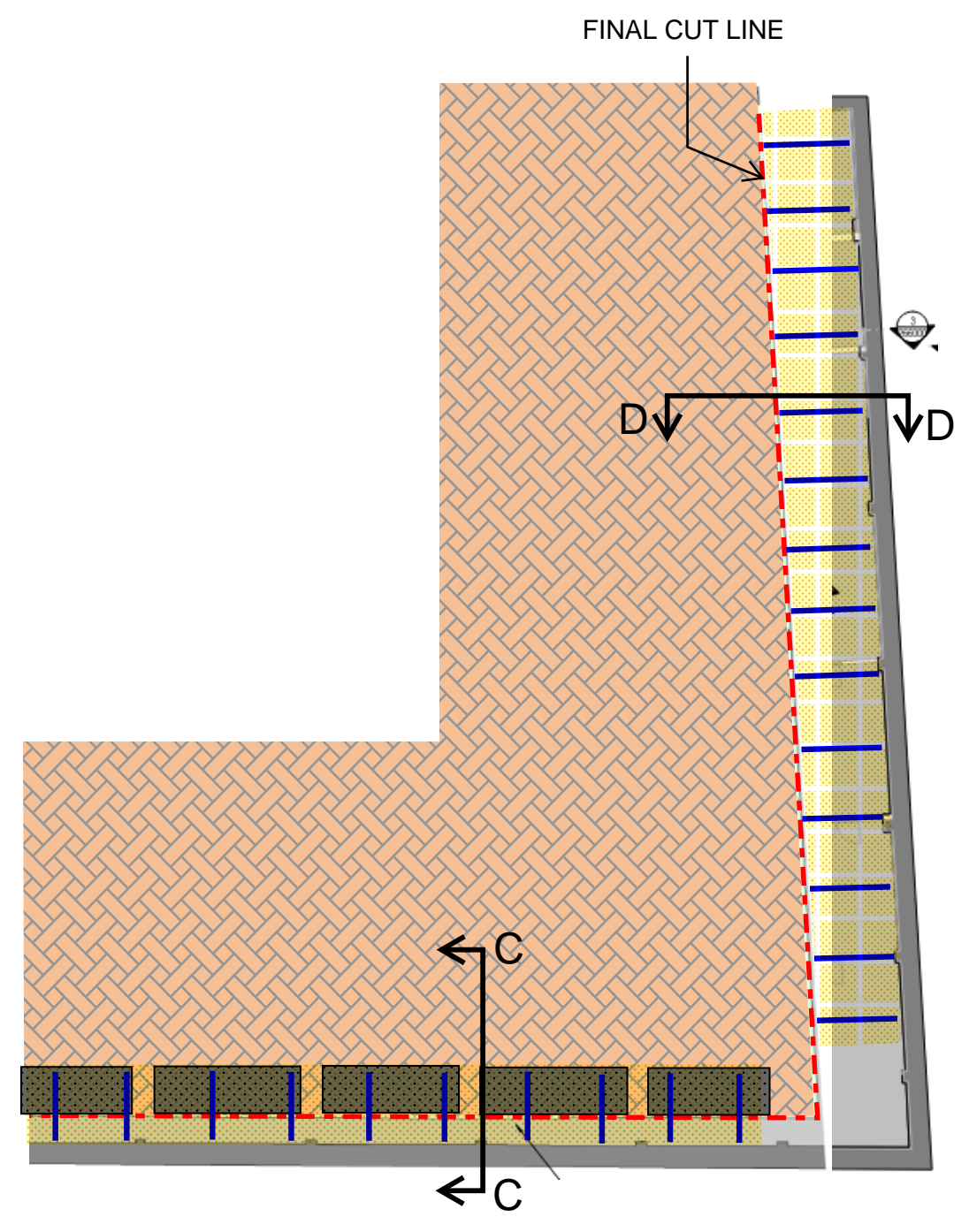

PROJECT TITLE	SKETCH TITLE	SKETCH No.	DRAWN	DATE
			SCALE	REV.



McGEE
A Specialist Engineering Contractor
McGee Group (Holdings) Ltd
Level 9 Alto Tower, 5 Hatfields
London SE1 9PG
Tel: 020 8998 1101 Fax: 020 8997 7690

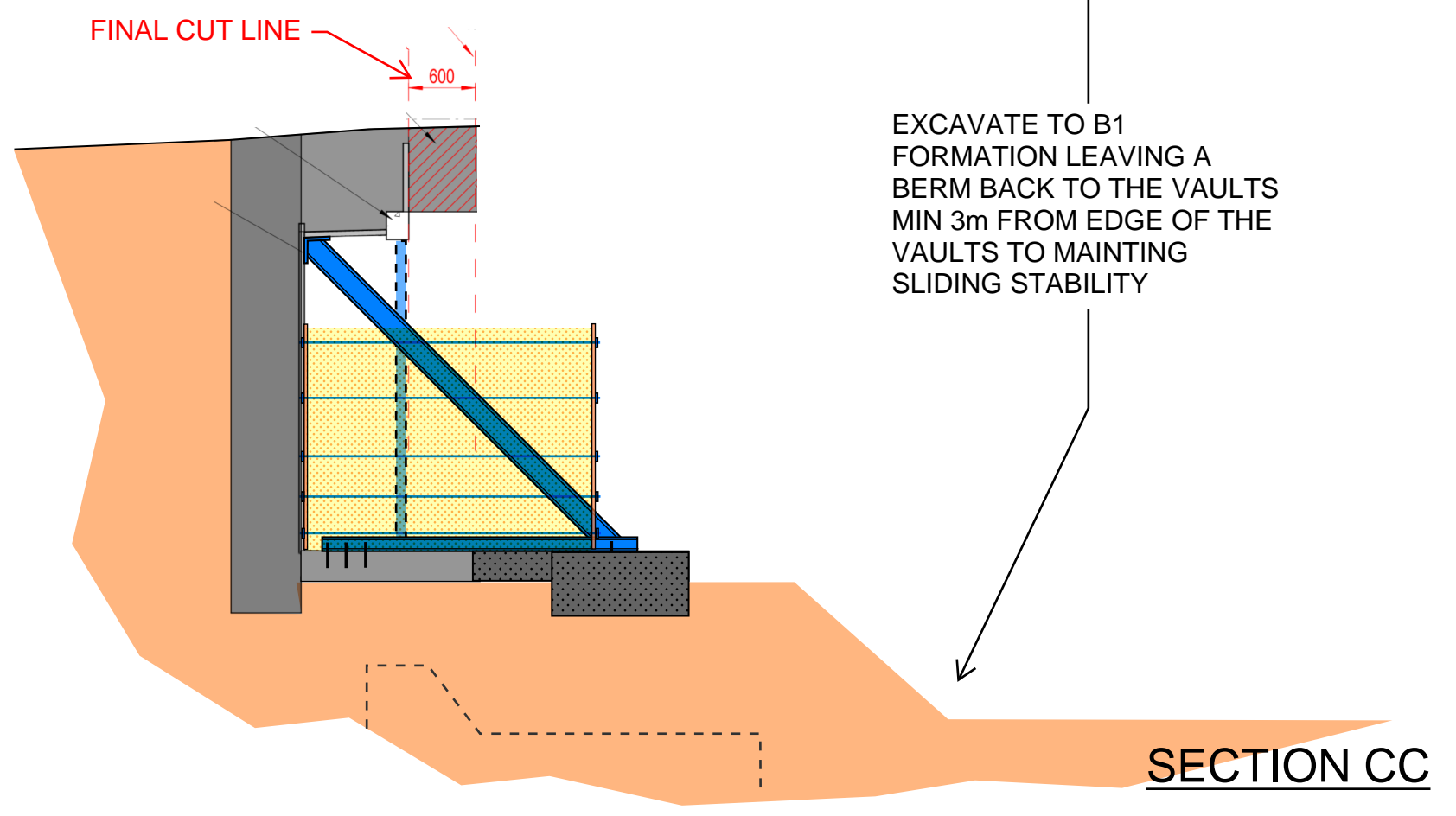
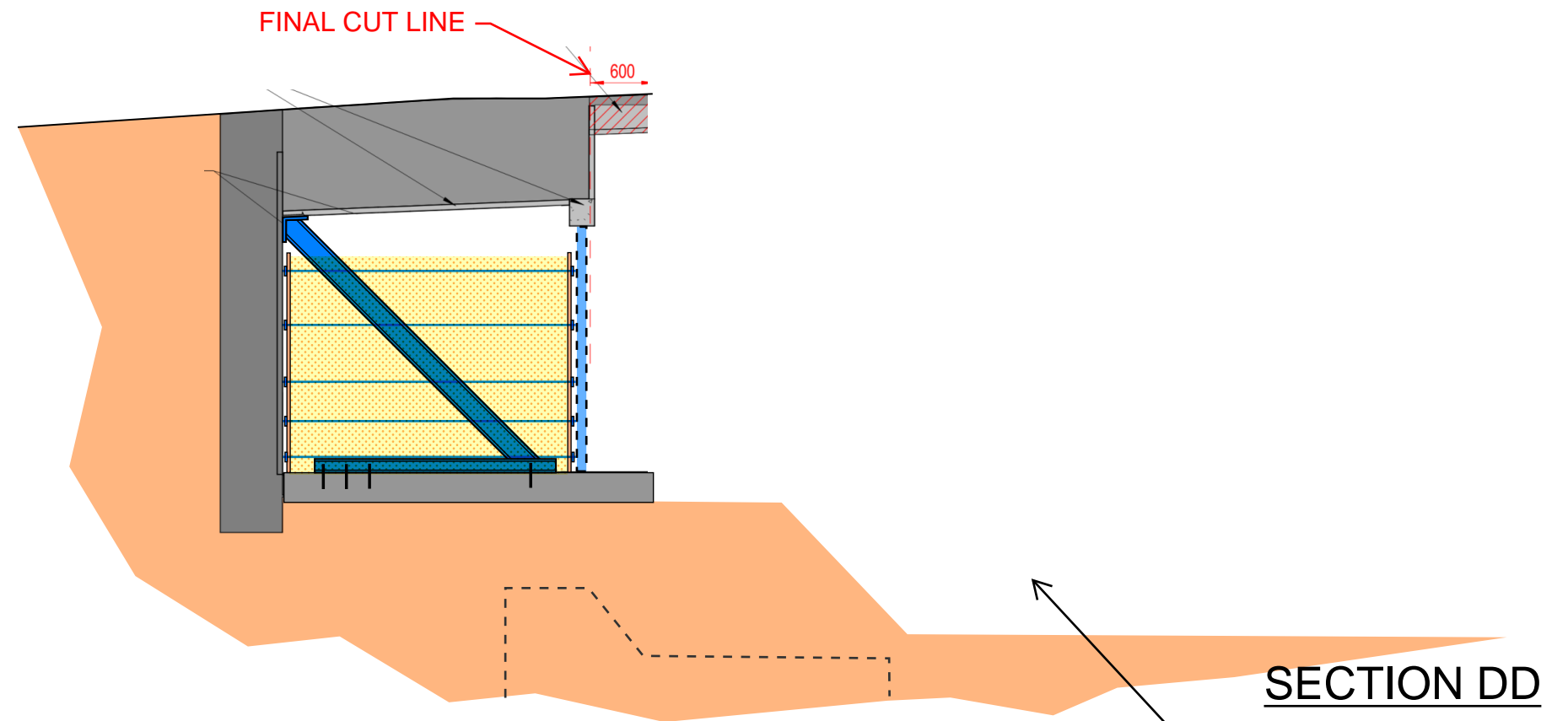
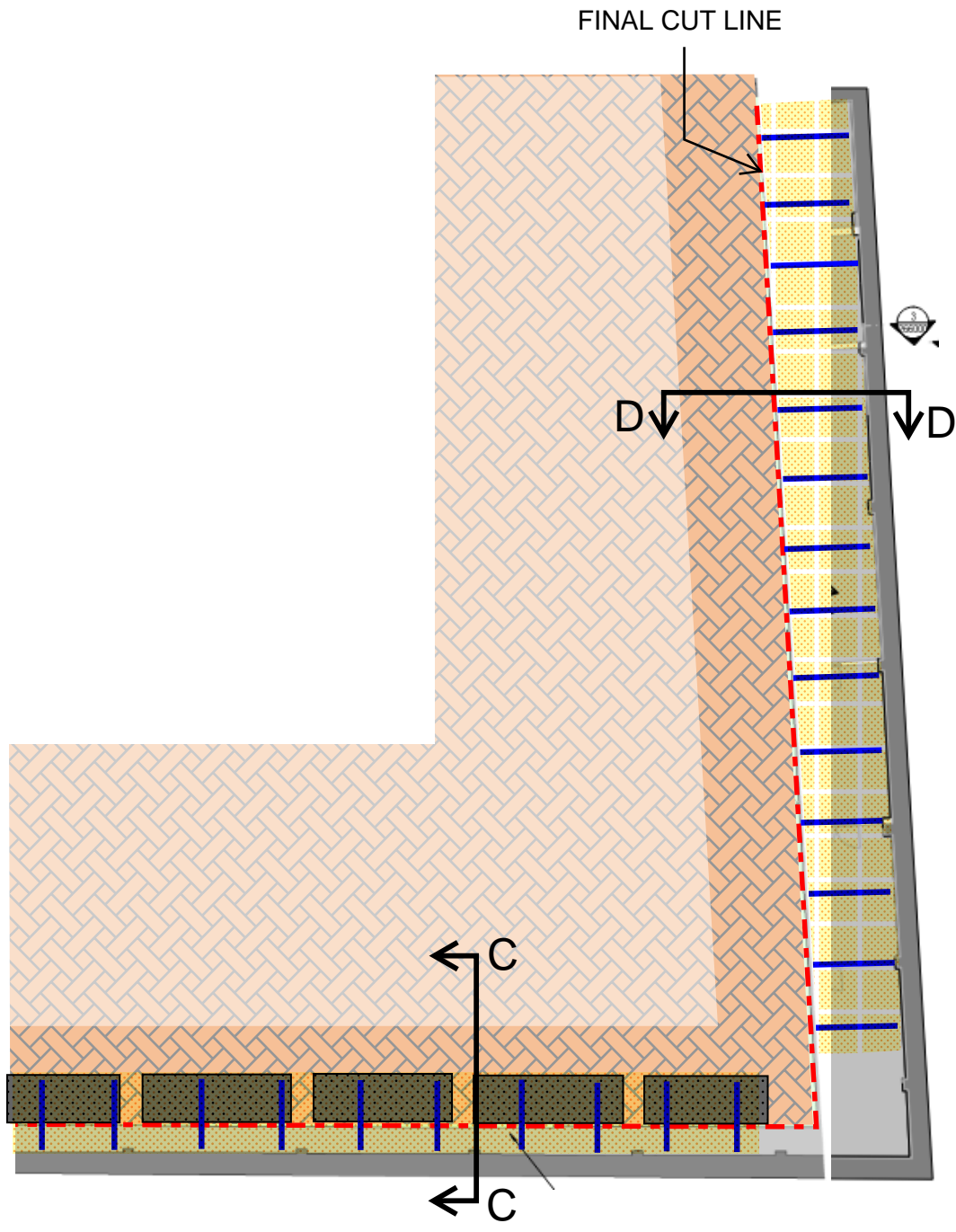

EXCAVATE TO B1 FORMATION LEAVING A BERM BACK TO THE VAULTS MIN 3m FROM EDGE OF THE VAULTS TO MAINTAINING SLIDING STABILITY

PROJECT TITLE	SKETCH TITLE	SKETCH No.	DRAWN	DATE	 <p>McGEE A Specialist Engineering Contractor McGee Group (Holdings) Ltd Level 9 Alto Tower, 5 Hatfields London SE1 9PG Tel: 020 8998 1101 Fax: 020 8997 7690</p>
			SCALE	REV.	

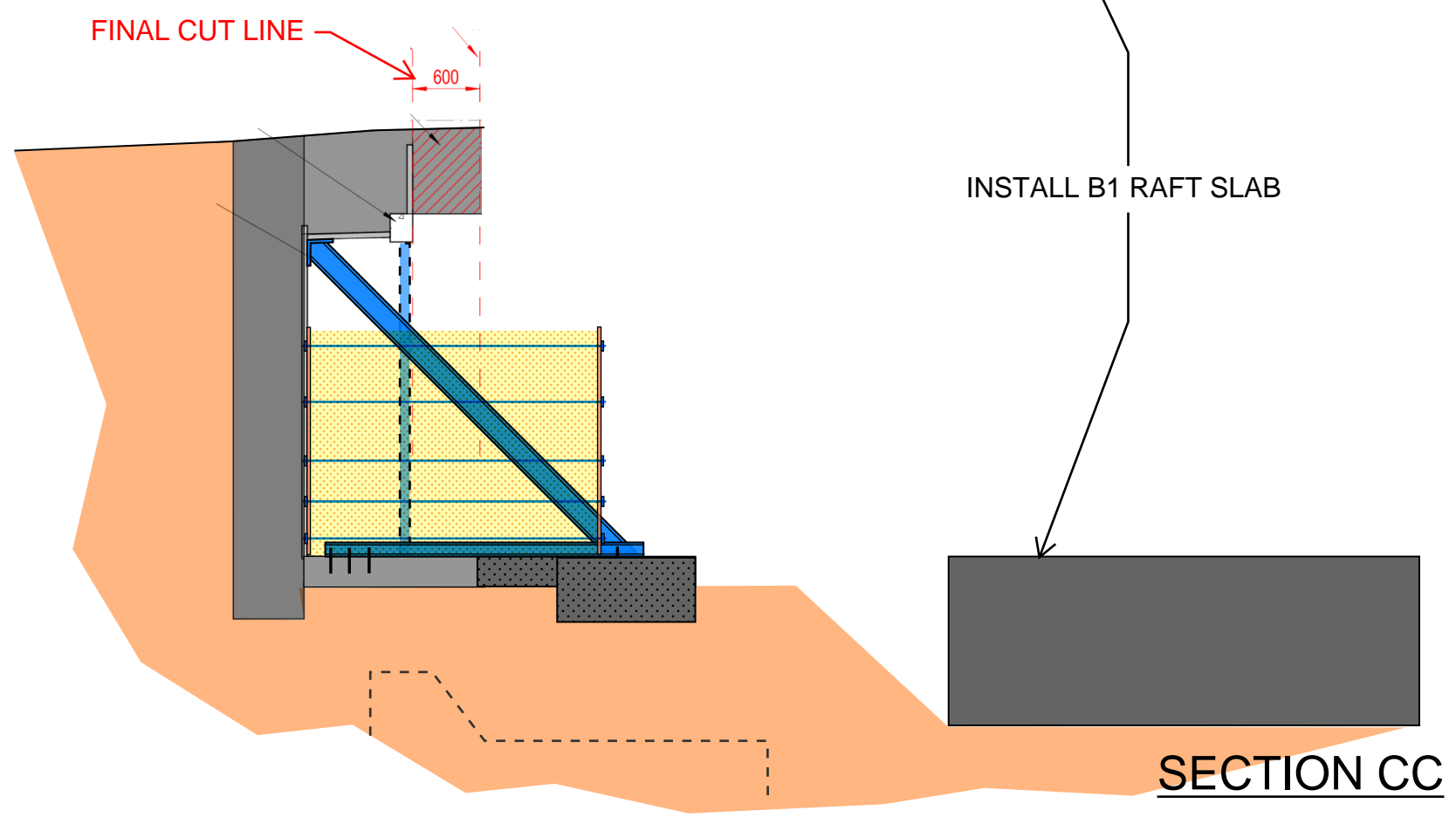
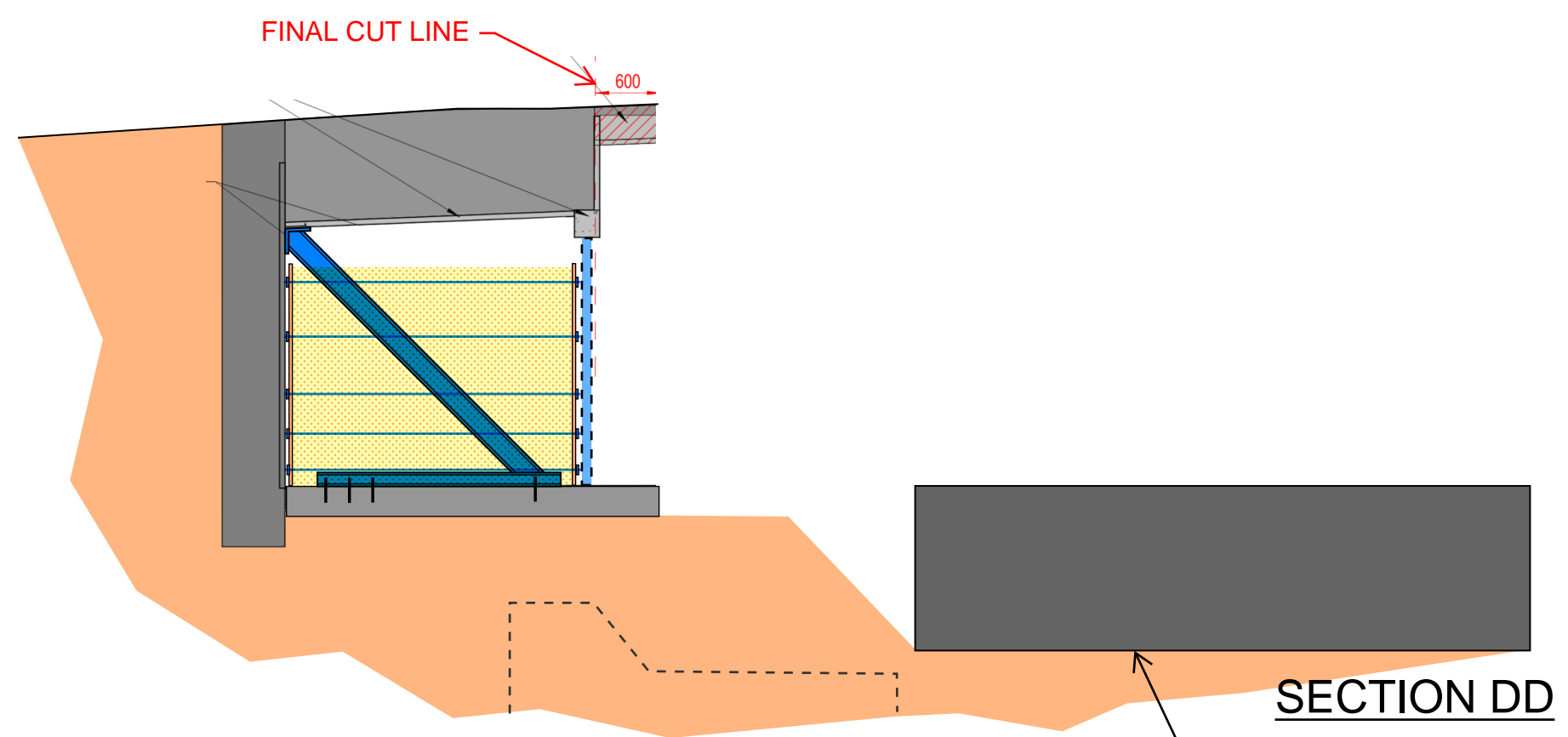
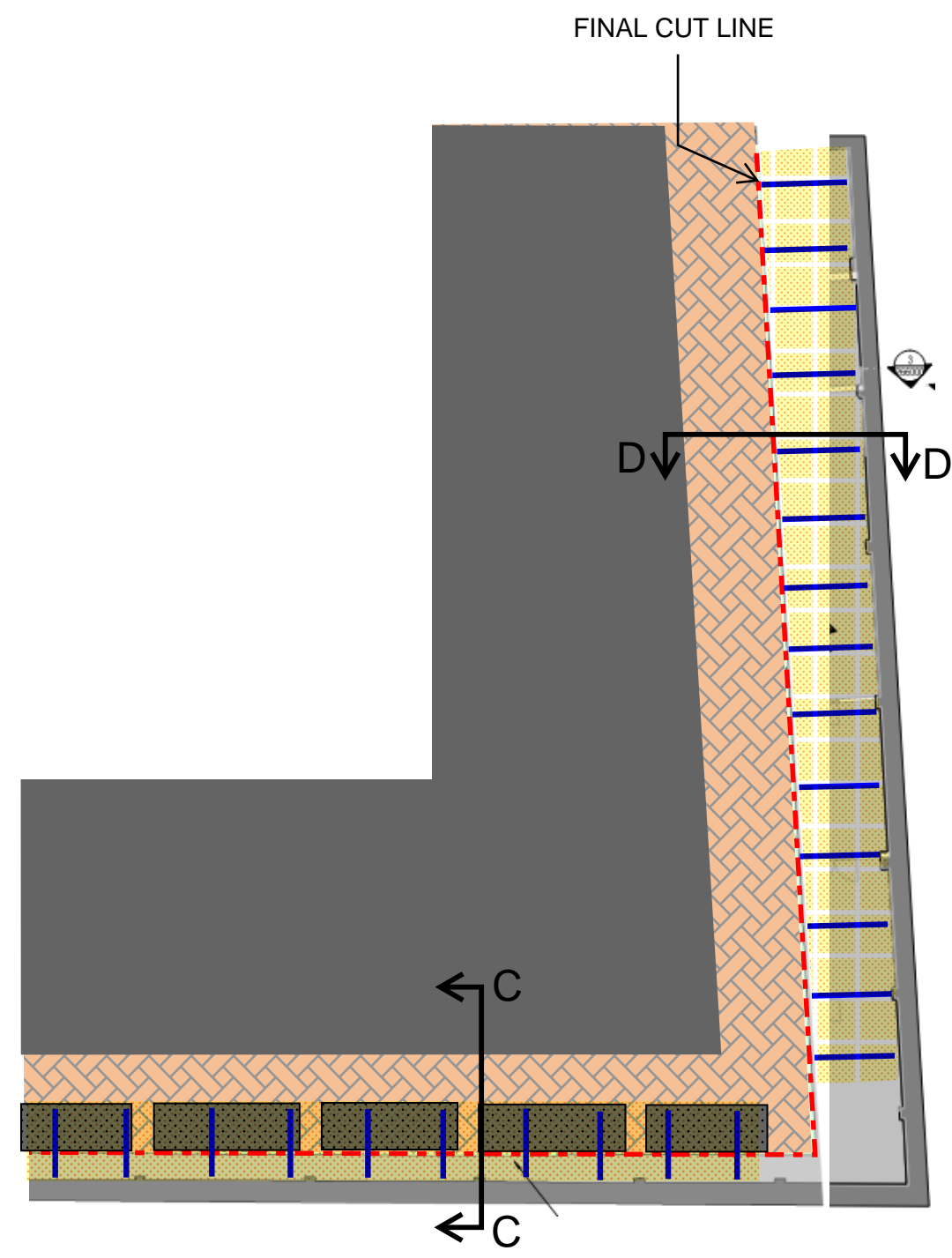

PROJECT TITLE	SKETCH TITLE

SKETCH No.	DRAWN	DATE

SCALE	REV.

McGEE
 A Specialist Engineering Contractor
 McGee Group (Holdings) Ltd
 Level 9 Alto Tower, 5 Hatfields
 London SE1 9PG
 Tel: 020 8998 1101 Fax: 020 8997 7690

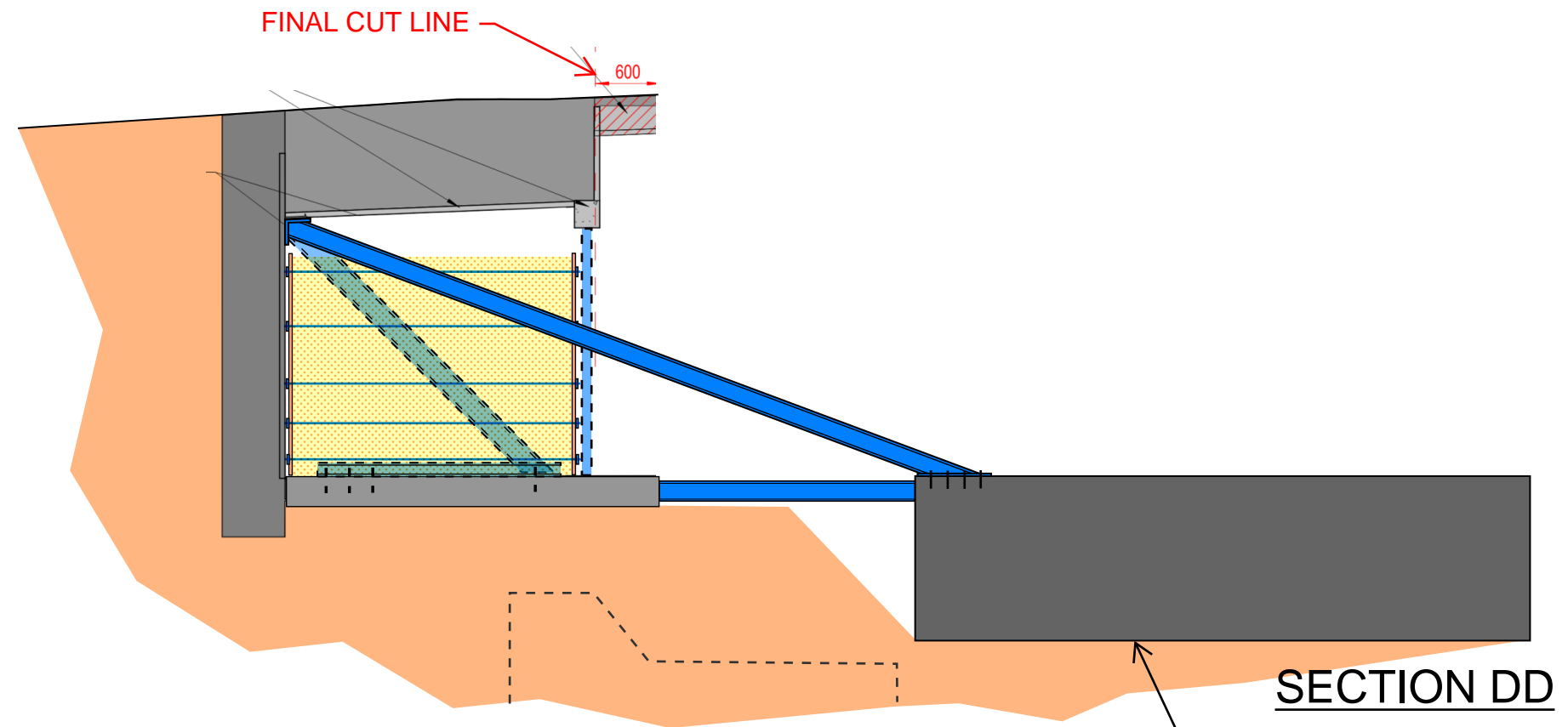
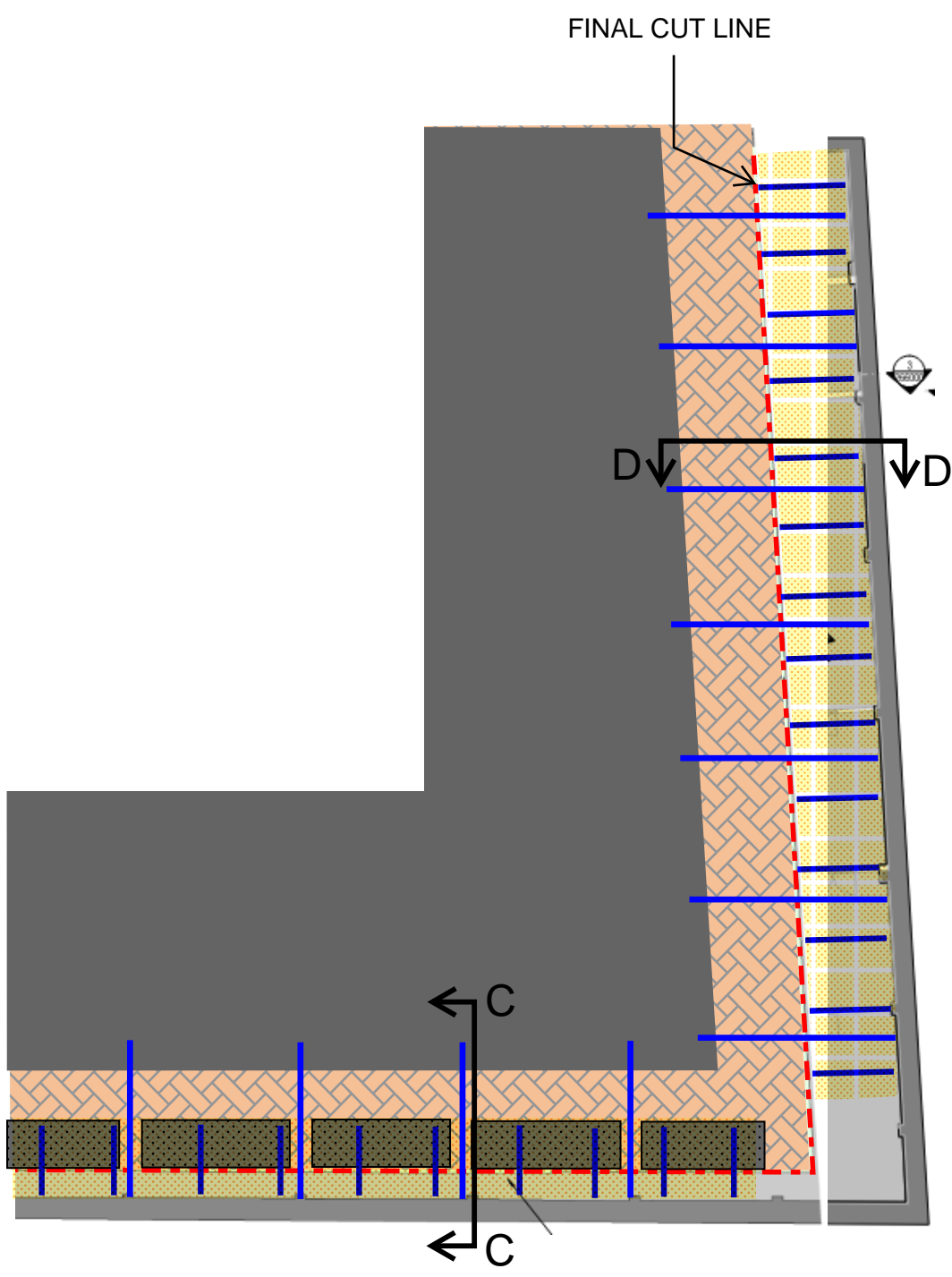

SECTION DD

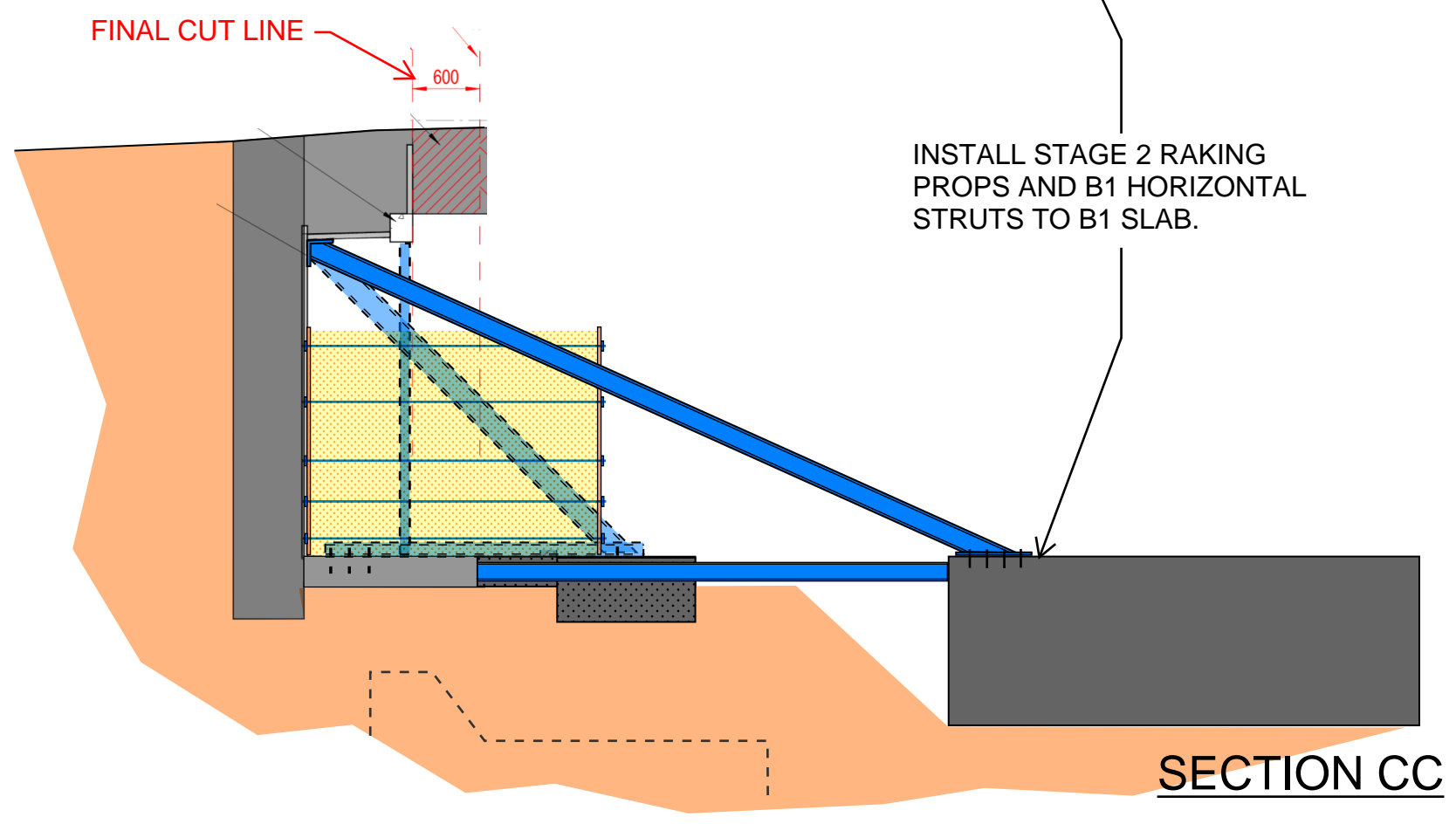

INSTALL STAGE 2 RAKING PROPS AND B1 HORIZONTAL STRUTS TO B1 SLAB.

SECTION CC

PROJECT TITLE	SKETCH TITLE	SKETCH No.	DRAWN	DATE	 <p>McGEE A Specialist Engineering Contractor McGee Group (Holdings) Ltd Level 9 Alto Tower, 5 Hatfields London SE1 9PG Tel: 020 8998 1101 Fax: 020 8997 7690</p>
			SCALE	REV.	

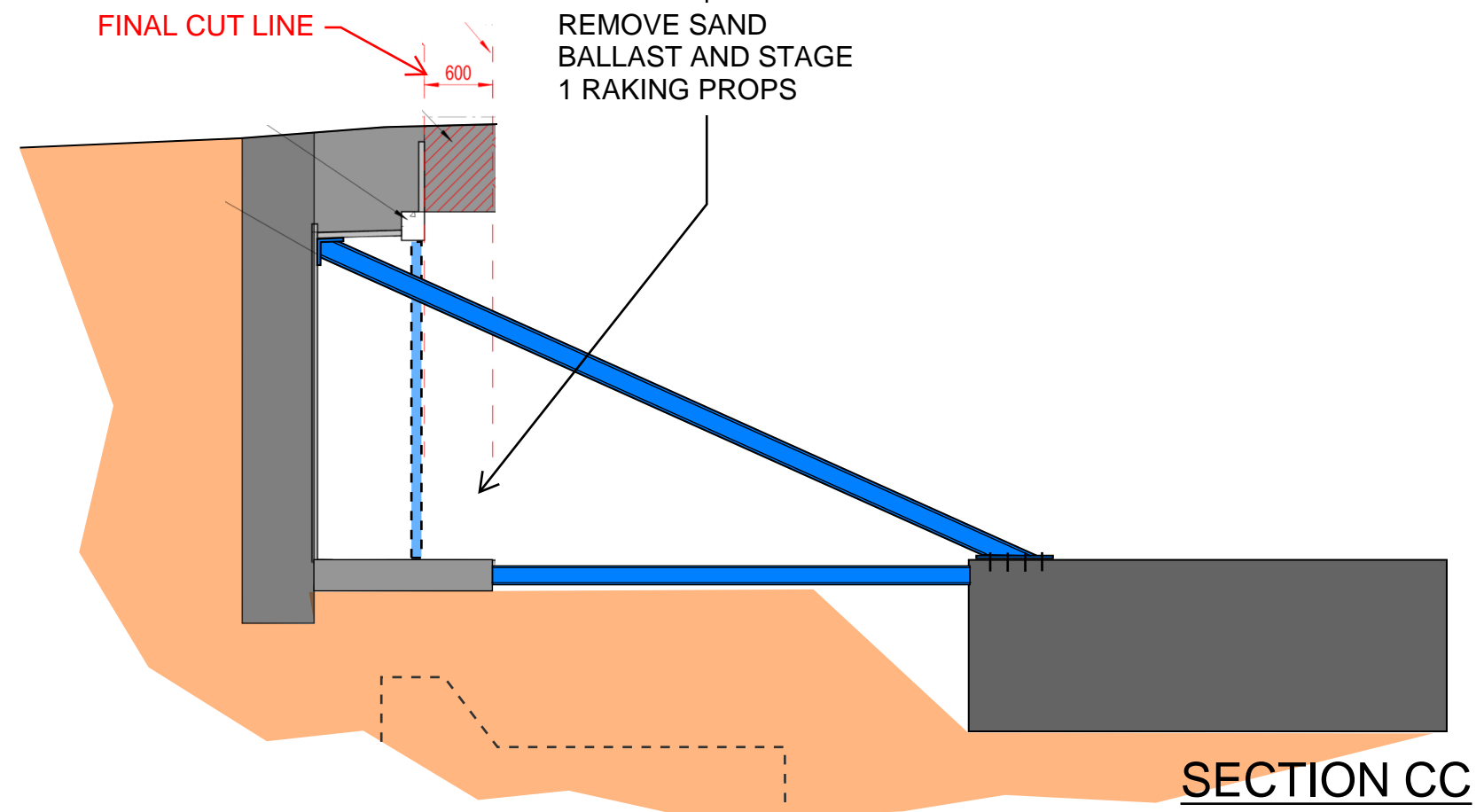
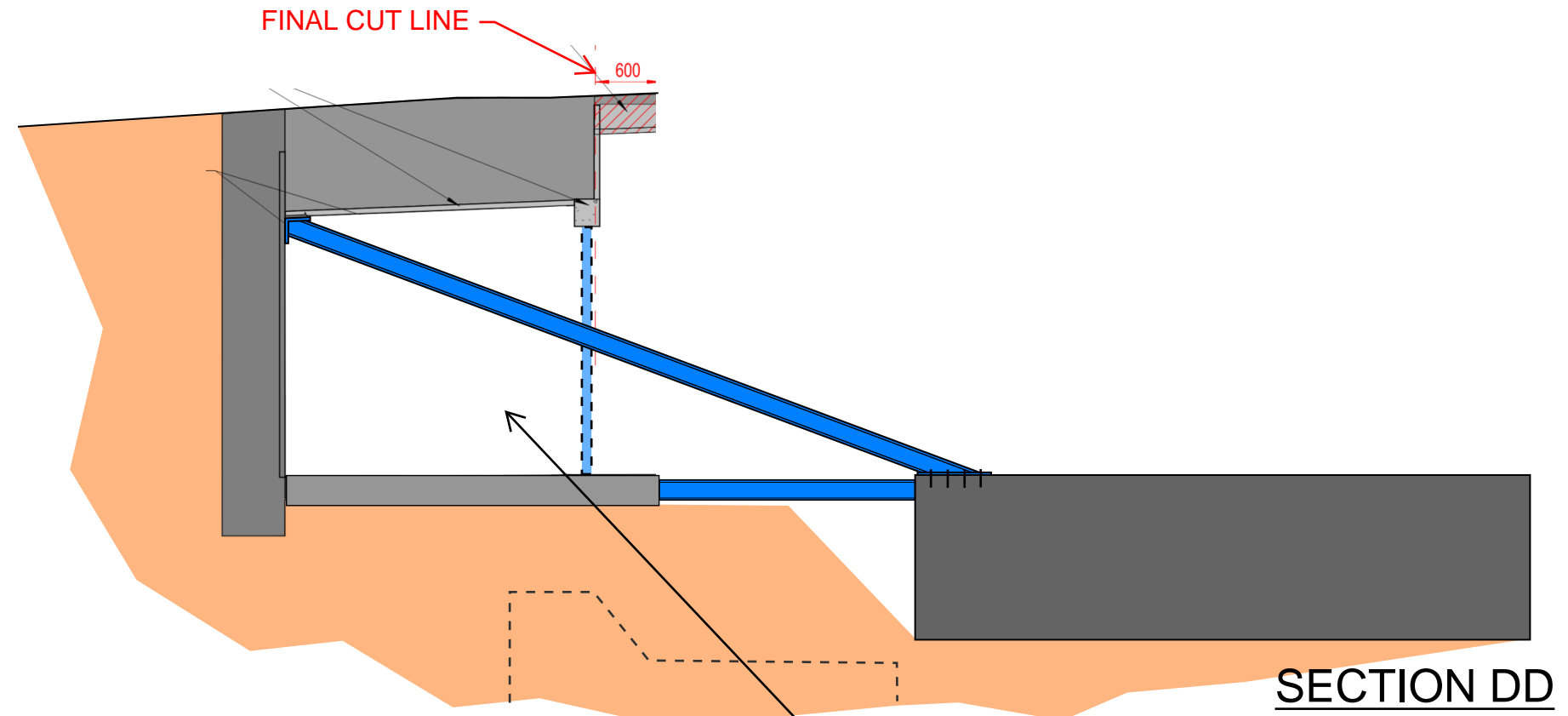
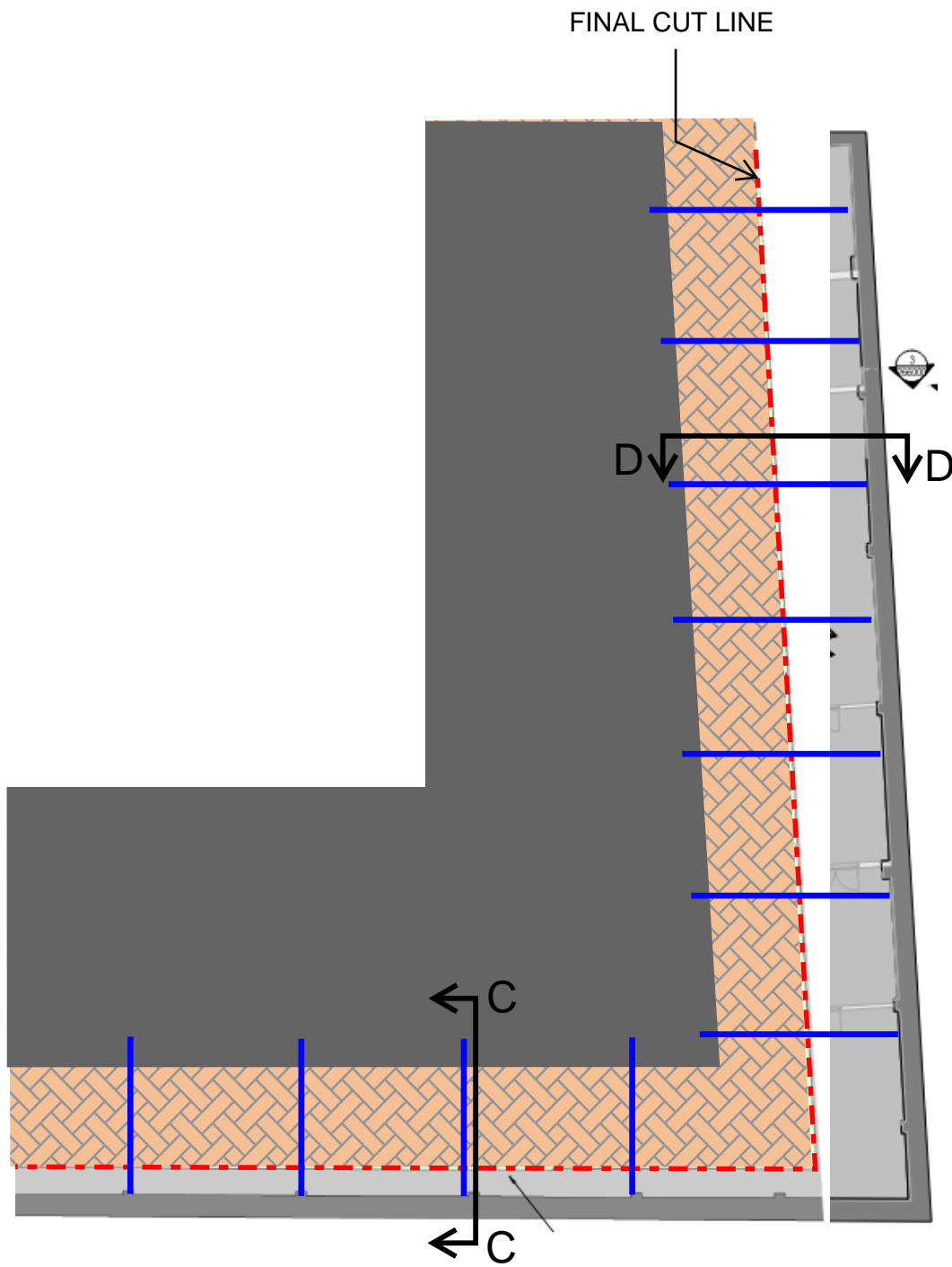

PROJECT TITLE	SKETCH TITLE	SKETCH No.	DRAWN	DATE	 McGEE A Specialist Engineering Contractor McGee Group (Holdings) Ltd Level 9 Alto Tower, 5 Hatfields London SE1 9PG Tel: 020 8998 1101 Fax: 020 8997 7690
			SCALE	REV.	

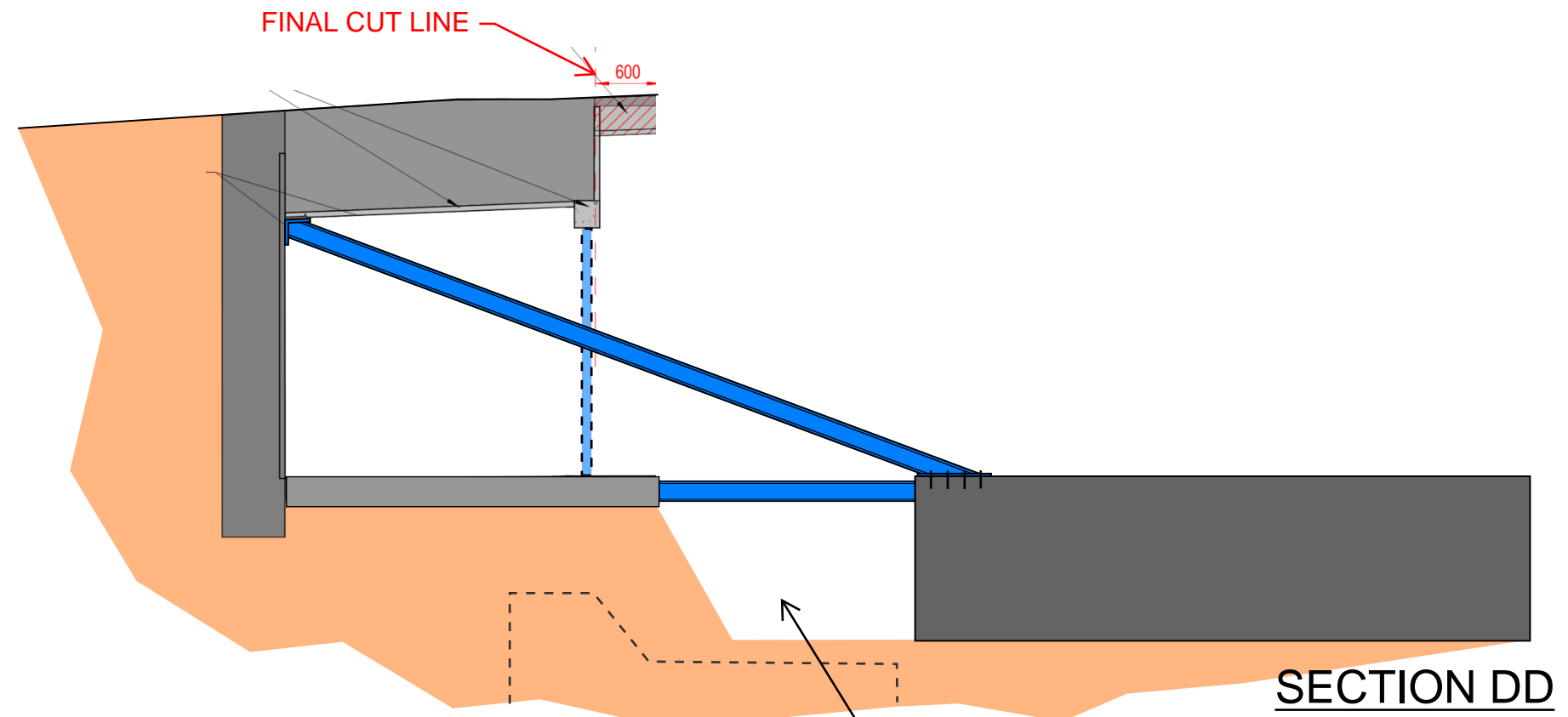
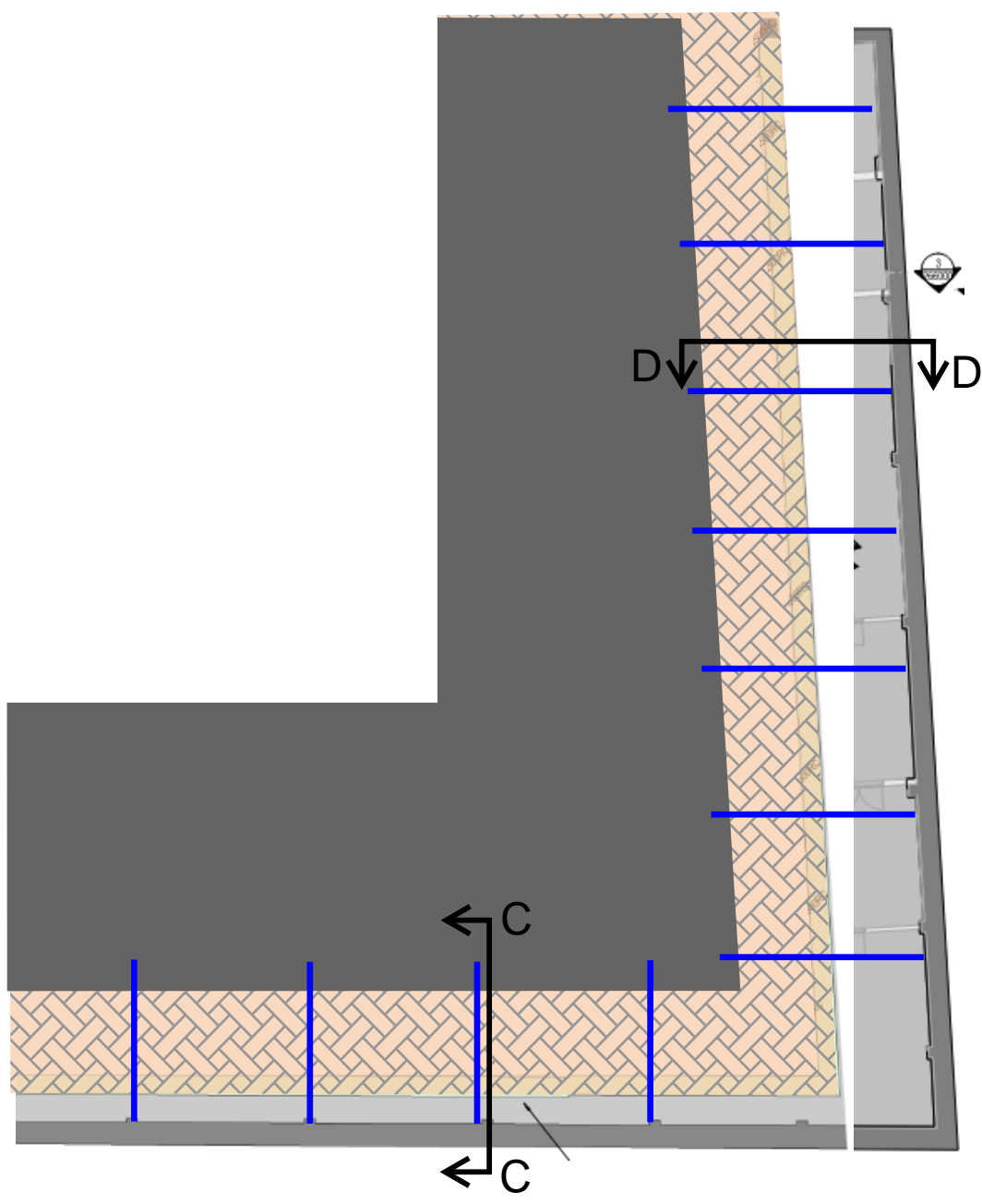

SECTION DD

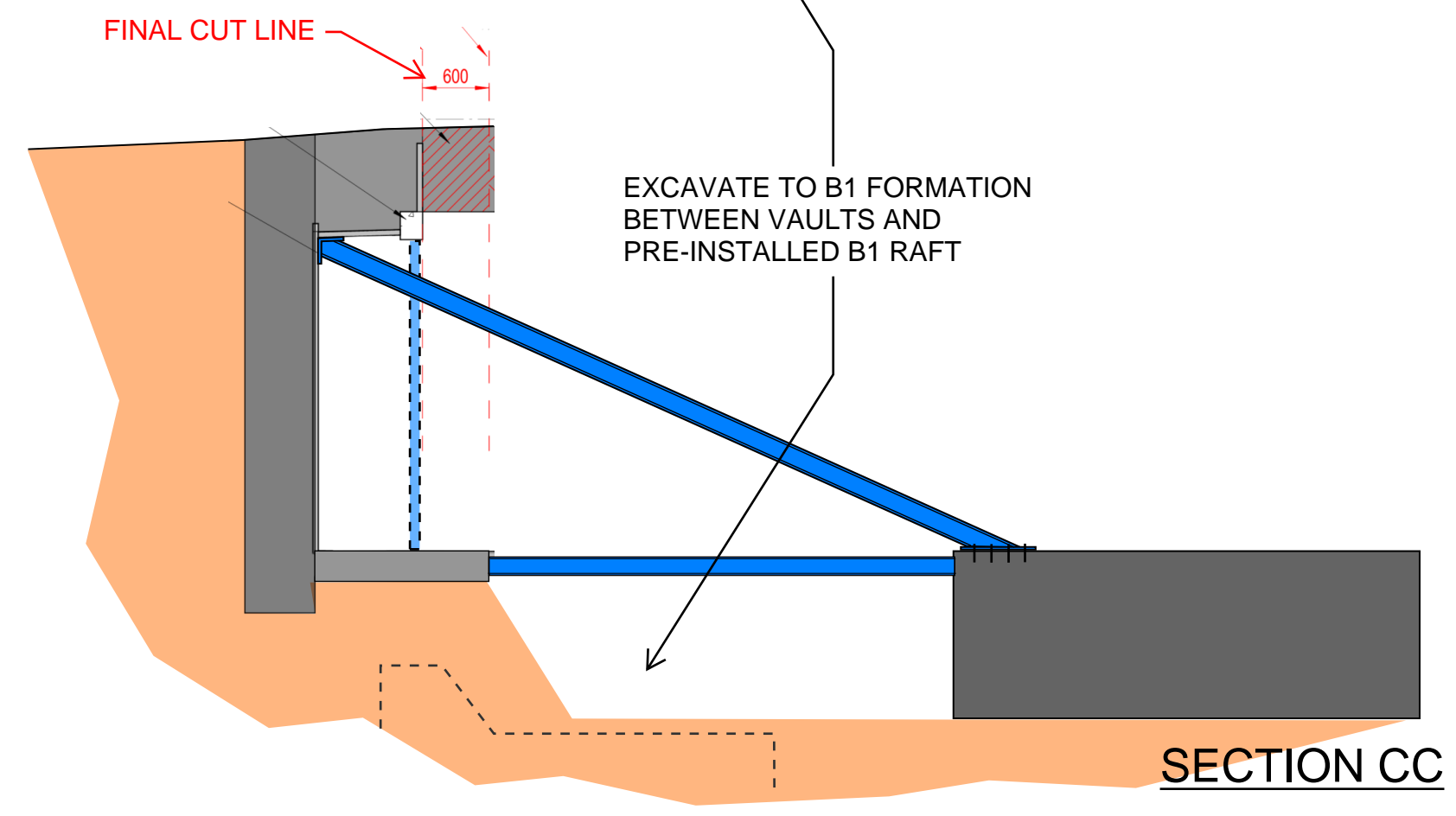

SECTION CC

PROJECT TITLE	SKETCH TITLE	SKETCH No.	DRAWN	DATE	 <p>McGEE A Specialist Engineering Contractor McGee Group (Holdings) Ltd Level 9 Alto Tower, 5 Hatfields London SE1 9PG Tel: 020 8998 1101 Fax: 020 8997 7690</p>
			SCALE	REV.	

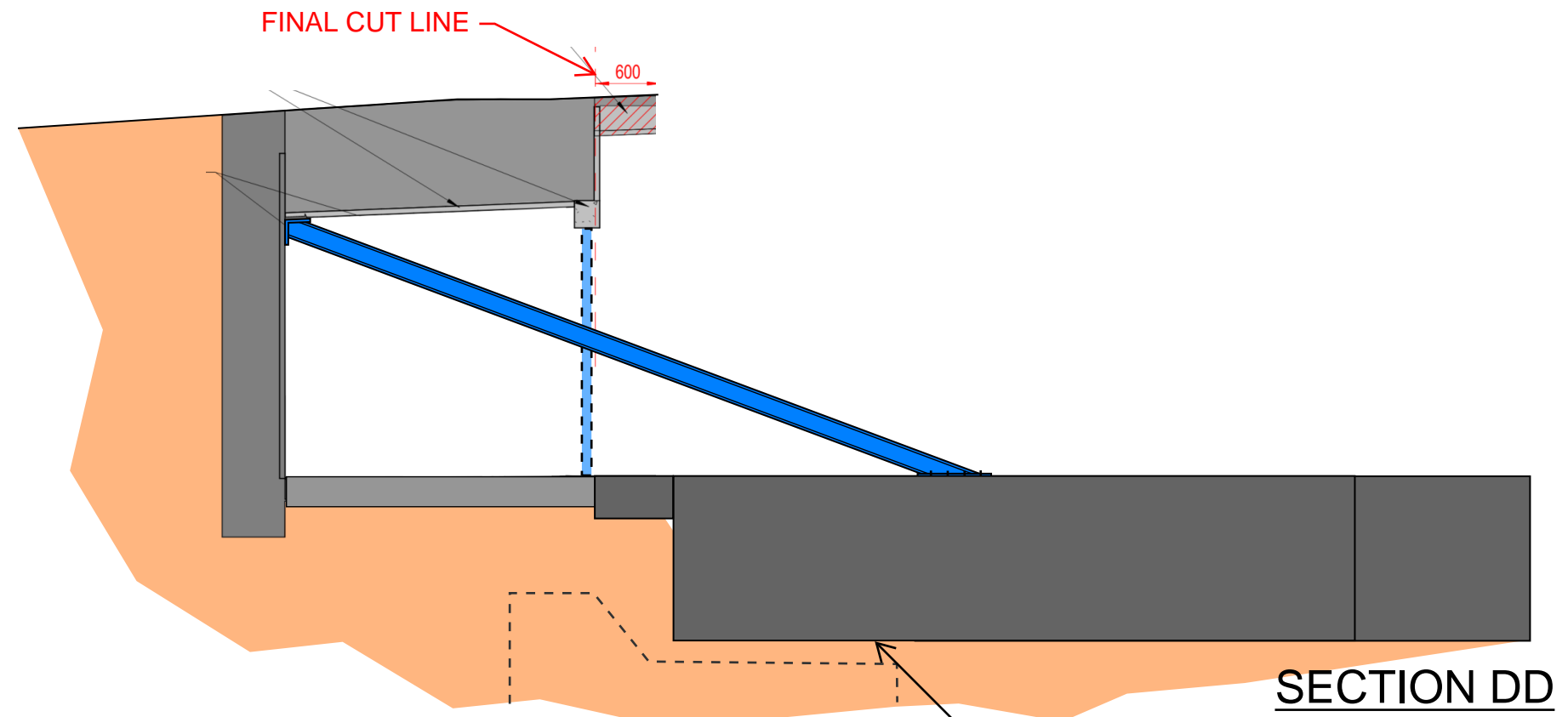
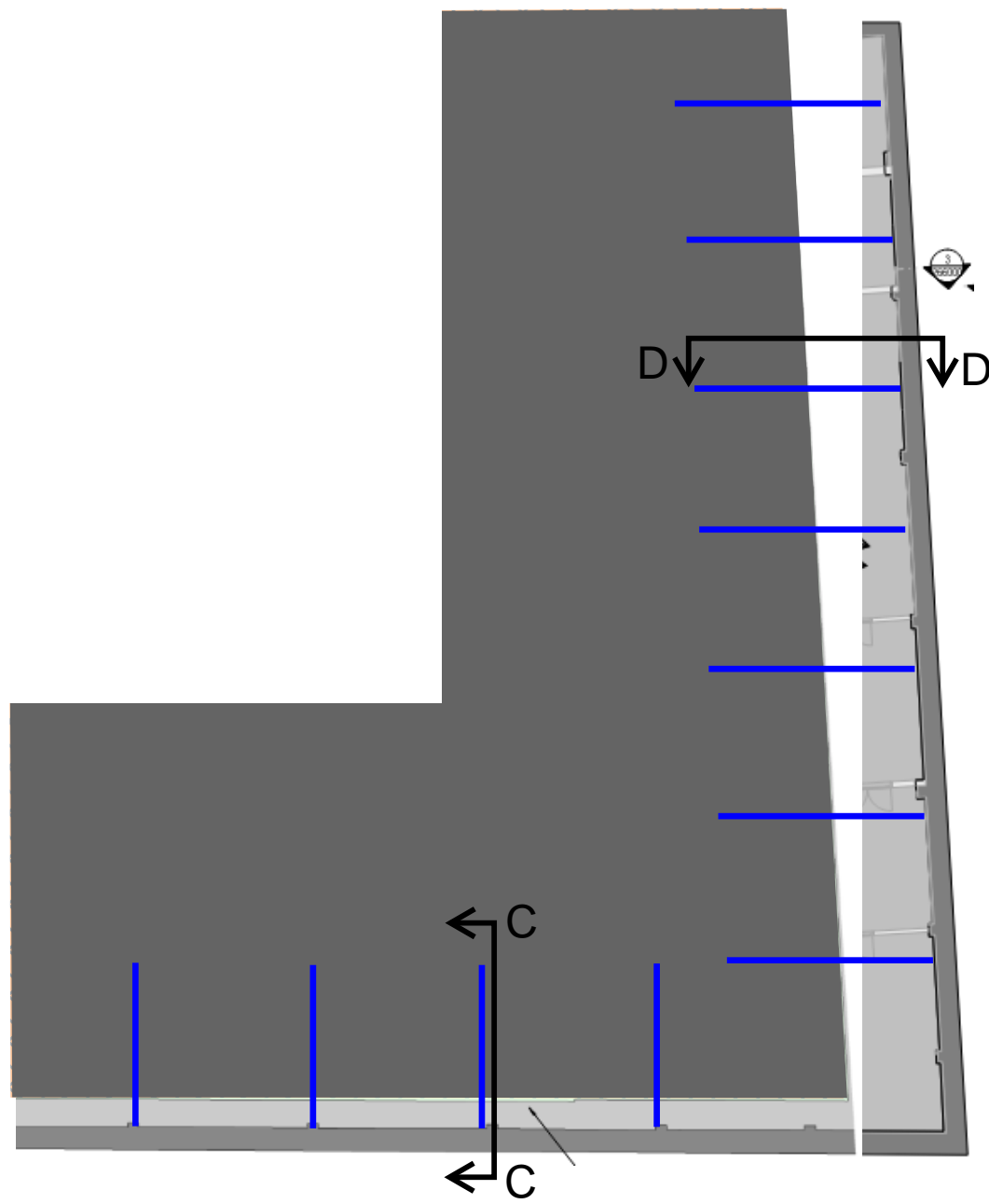

SECTION DD

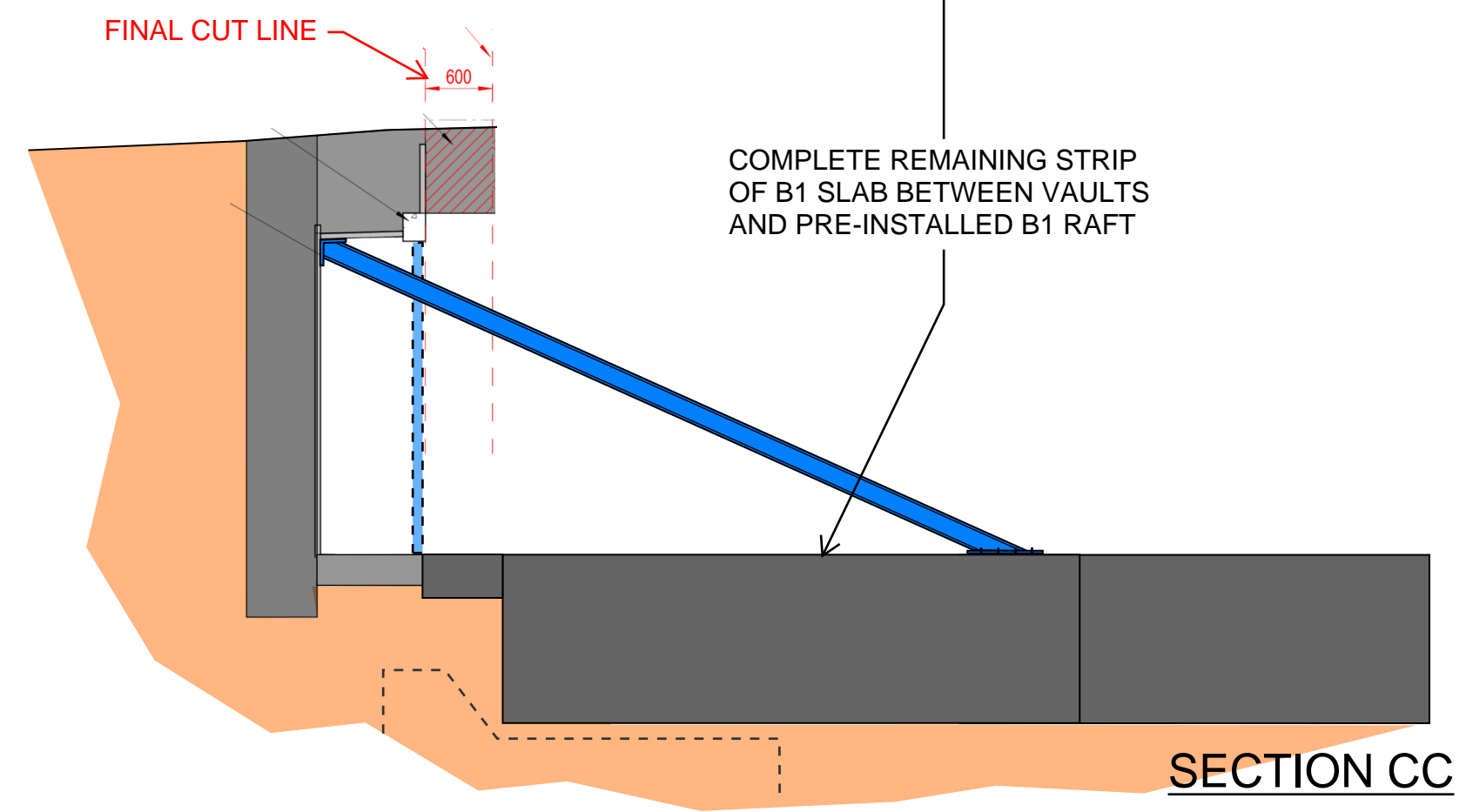

SECTION CC

PROJECT TITLE	SKETCH TITLE	SKETCH No.	DRAWN	DATE	 <p>McGEE A Specialist Engineering Contractor McGee Group (Holdings) Ltd Level 9 Alto Tower, 5 Hatfields London SE1 9PG Tel: 020 8998 1101 Fax: 020 8997 7690</p>
			SCALE	REV.	